

IBM® Rational® DOORS

*The DXL Reference Manual*

**IBM**®



*IBM Rational DOORS  
DXL Reference Manual  
Release 9.6.1*

Before using this information, be sure to read the general information under the "Notices" chapter on page 959.

This edition applies to version 9.6.1 of IBM Rational DOORS and to all subsequent releases and modifications until otherwise indicated in new editions.

© **Copyright IBM Corporation 1993, 2017**

US Government Users Restricted Rights—Use, duplication or disclosure restricted by GSA ADP Schedule Contract with IBM Corp.





# Table of Contents

	<b>About this manual. . . . .</b>	<b>1</b>
	Typographical conventions . . . . .	1
	Related documentation. . . . .	2
<b>Chapter 1</b>	<b>Introduction . . . . .</b>	<b>3</b>
	Developing DXL programs . . . . .	3
	Browsing the DXL library . . . . .	5
	Localizing DXL . . . . .	6
	Language fundamentals . . . . .	7
	Lexical conventions . . . . .	10
	Constants . . . . .	12
	Identifiers . . . . .	14
	Types . . . . .	15
	Declarations . . . . .	15
	Expressions . . . . .	18
	Statements . . . . .	20
	Basic functions . . . . .	24
<b>Chapter 2</b>	<b>New in DXL for Rational DOORS 9.6.1 . . . . .</b>	<b>29</b>
	Object Management functions. . . . .	29
	Module Properties . . . . .	30
	Dialog box functions . . . . .	30
	Display control functions. . . . .	30
	OLE objects . . . . .	31
	General functions . . . . .	31
	OSLC DXL Services . . . . .	33
	Timer. . . . .	34
	Triggers . . . . .	35
<b>Chapter 3</b>	<b>New in DXL for Rational DOORS 9.6 . . . . .</b>	<b>37</b>
	Operating system interface. . . . .	37
	Mini database explorer . . . . .	37
	Modules. . . . .	38
	History. . . . .	38
	Dialog box functions: common element operations. . . . .	39
	Display control: columns . . . . .	39
	Display control: Layout DXL . . . . .	40
	HTTP Server. . . . .	40
<b>Chapter 4</b>	<b>New in DXL for Rational DOORS 9.5 . . . . .</b>	<b>41</b>
	Embedded OLE objects and the OLE clipboard. . . . .	41
	OSLC Link Discovery . . . . .	42
	Database properties . . . . .	43

	Rational Directory Server .....	46
<b>Chapter 5</b>	<b>New in DXL for Rational DOORS 9.4 .....</b>	<b>49</b>
	Attribute definitions .....	49
	Attribute types .....	50
	Rich text strings .....	51
<b>Chapter 6</b>	<b>New in DXL for Rational DOORS 9.3 .....</b>	<b>53</b>
	Converting a symbol character to Unicode .....	53
	Dialog box functions .....	54
	Operations on type string .....	54
	Embedded OLE objects and the OLE clipboard .....	56
	OLE information functions .....	56
	Discussions .....	57
	RIF ID .....	60
	Rational DOORS URLs .....	60
	Filters .....	61
	Compound Filters .....	63
	Localizing DXL .....	64
	Finding links .....	65
	Links .....	67
<b>Chapter 7</b>	<b>New in DXL for Rational DOORS 9.2 .....</b>	<b>69</b>
	Additional authentication .....	69
	Dialog box updates .....	70
	New constants .....	71
	Partitions updates .....	72
	Requirements Interchange Format (RIF) .....	73
<b>Chapter 8</b>	<b>New in DXL for Rational DOORS 9.1 .....</b>	<b>83</b>
	Regular Expressions .....	83
<b>Chapter 9</b>	<b>New in DXL for Rational DOORS 9.0 .....</b>	<b>85</b>
	Discussions .....	85
	Discussion Types .....	85
	Properties .....	86
	Iterators .....	88
	Operations .....	90
	Triggers .....	92
	Example .....	93
	Descriptions .....	95
	View Descriptions .....	95
	Attribute Type Descriptions .....	95
	Attribute Definition Descriptions .....	97
	Filtering .....	98
	HTML .....	98



	HTML Control . . . . .	99
	HTML Edit Control . . . . .	109
	Miscellaneous . . . . .	111
<b>Chapter 10</b>	<b>Fundamental types and functions . . . . .</b>	<b>113</b>
	Operations on all types . . . . .	113
	Operations on type bool . . . . .	115
	Operations on type char . . . . .	116
	Operations on type int . . . . .	119
	Operations on type real . . . . .	122
	Operations on type string . . . . .	126
<b>Chapter 11</b>	<b>General language facilities . . . . .</b>	<b>133</b>
	Files and streams . . . . .	133
	Configuration file access . . . . .	141
	Dates . . . . .	147
	Skip lists . . . . .	154
	Regular expressions . . . . .	158
	Text buffers . . . . .	163
	Arrays . . . . .	172
<b>Chapter 12</b>	<b>Operating system interface . . . . .</b>	<b>177</b>
	Operating system commands . . . . .	177
	Windows registry . . . . .	184
	Interprocess communications . . . . .	187
	System clipboard functions . . . . .	190
<b>Chapter 13</b>	<b>Customizing Rational DOORS . . . . .</b>	<b>193</b>
	Color schemes . . . . .	193
	Database Explorer options . . . . .	195
	Mini database explorer . . . . .	198
	Locales . . . . .	199
	Codepages . . . . .	205
	Message of the day . . . . .	209
	Database Properties . . . . .	210
<b>Chapter 14</b>	<b>Rational DOORS database access . . . . .</b>	<b>213</b>
	Database properties . . . . .	213
	Group and user manipulation . . . . .	230
	Group and user management . . . . .	238
	LDAP . . . . .	248
	LDAP Configuration . . . . .	250
	LDAP server information . . . . .	252
	LDAP data configuration . . . . .	256
	Rational Directory Server . . . . .	260

<b>Chapter 15</b>	<b>Rational DOORS hierarchy</b> .....	<b>265</b>
	About the Rational DOORS hierarchy.....	265
	Item access controls.....	266
	Hierarchy clipboard.....	267
	Hierarchy information.....	270
	Hierarchy manipulation.....	274
	Items.....	276
	Folders.....	279
	Projects.....	282
	Looping within projects.....	287
<b>Chapter 16</b>	<b>Modules</b> .....	<b>289</b>
	Module access controls.....	289
	Module references.....	290
	Module information.....	293
	Module manipulation.....	297
	Module display state.....	302
	Baselines.....	305
	Baseline Set Definition.....	313
	Baseline Sets.....	322
	History.....	331
	Descriptive modules.....	341
	Recently opened modules.....	344
	Module Properties.....	346
<b>Chapter 17</b>	<b>Electronic Signatures</b> .....	<b>351</b>
	Signature types.....	351
	Controlling Electronic Signature ACL.....	351
	Electronic Signature Data Manipulation.....	355
	Examples.....	360
<b>Chapter 18</b>	<b>Objects</b> .....	<b>369</b>
	About objects.....	369
	Object access controls.....	369
	Finding objects.....	371
	Current object.....	376
	Navigation from an object.....	377
	Object management.....	380
	Information about objects.....	384
	Selecting objects.....	386
	Object searching.....	388
	Miscellaneous object functions.....	389
<b>Chapter 19</b>	<b>Links</b> .....	<b>393</b>
	About links and link module descriptors.....	393
	Link creation.....	394
	Link access control.....	394

Finding links . . . . .395  
 Versioned links . . . . .401  
 Link management . . . . .404  
 Default link module . . . . .410  
 Linksets . . . . .410  
 External Links . . . . .413  
 OSLC Link Discovery . . . . .417  
 Rational DOORS URLs . . . . .418

**Chapter 20 Attributes . . . . .427**

Attribute values . . . . .427  
 Attribute value access controls . . . . .434  
 Multi-value enumerated attributes . . . . .435  
 Attribute definitions . . . . .437  
 Attribute definition access controls . . . . .448  
 Attribute types . . . . .450  
 Attribute type access controls . . . . .456  
 Attribute type manipulation . . . . .457  
 DXL attribute . . . . .463

**Chapter 21 Access controls . . . . .467**

Controlling access . . . . .467  
 Locking . . . . .476  
 Example programs . . . . .477

**Chapter 22 Dialog boxes . . . . .481**

Icons . . . . .481  
 Message boxes . . . . .484  
 Dialog box functions . . . . .487  
 Dialog box elements . . . . .499  
 Common element operations . . . . .499  
 Simple elements for dialog boxes . . . . .523  
 Choice dialog box elements . . . . .538  
 View elements . . . . .543  
 Text editor elements . . . . .551  
 Buttons . . . . .554  
 Canvases . . . . .558  
 Complex canvases . . . . .572  
 Toolbars . . . . .583  
 Colors . . . . .588  
 Simple placement . . . . .594  
 Constrained placement . . . . .597  
 Progress bar . . . . .603  
 DBE resizing . . . . .606  
 HTML Control . . . . .607  
 HTML Edit Control . . . . .617

<b>Chapter 23</b>	<b>Templates</b> .....	<b>619</b>
	Template functions .....	619
	Template expressions .....	620
<b>Chapter 24</b>	<b>Rational DOORS window control</b> .....	<b>623</b>
	The DXL Library and Addins menus .....	623
	Module status bars .....	625
	Rational DOORS built-in windows .....	626
	Module menus .....	628
<b>Chapter 25</b>	<b>Display control</b> .....	<b>643</b>
	Filters .....	643
	Compound filters .....	654
	Filtering on multi-valued attributes .....	658
	Sorting modules .....	659
	Views .....	663
	View access controls .....	674
	View definitions .....	676
	Columns .....	686
	Scrolling functions .....	695
	Layout DXL .....	696
<b>Chapter 26</b>	<b>Partitions</b> .....	<b>701</b>
	Partition concepts .....	701
	Partition definition management .....	701
	Partition definition contents .....	704
	Partition management .....	710
	Partition information .....	713
	Partition access .....	718
<b>Chapter 27</b>	<b>Requirements Interchange Format (RIF)</b> .....	<b>721</b>
	RIF export .....	721
	RIF import .....	722
	RIF ID .....	723
	Merge .....	724
	RIF definition .....	724
	Examples .....	727
<b>Chapter 28</b>	<b>OLE objects</b> .....	<b>733</b>
	Embedded OLE objects and the OLE clipboard .....	733
	OLE information functions .....	744
	Picture object support .....	751
	Automation client support .....	762
	Controlling Rational DOORS from applications that support automation .....	767
<b>Chapter 29</b>	<b>Triggers</b> .....	<b>771</b>

- Introduction to triggers .....771
- Trigger constants .....774
- Trigger definition .....776
- Trigger manipulation .....779
- Drag-and-drop trigger functions .....788
  
- Chapter 30 Page setup functions .....801**
  - Page attributes status .....801
  - Page dimensions .....802
  - Document attributes .....805
  - Page setup information .....808
  - Page setup management .....811
  
- Chapter 31 Tables .....813**
  - Table concept .....813
  - Table constants .....813
  - Table management .....814
  - Table manipulation .....818
  - Table attributes .....826
  
- Chapter 32 Rich text .....829**
  - Rich text processing .....829
  - Rich text strings .....836
  - Enhanced character support .....848
  - Importing rich text .....851
  - Diagnostic perms .....852
  
- Chapter 33 Spelling Checker .....857**
  - Constants and general functions .....857
  - Language and Grammar .....866
  - Spelling Dictionary .....875
  - Miscellaneous Spelling .....878
  - Spelling\Dictionary Examples .....880
  
- Chapter 34 Database Integrity Checker .....883**
  - Database Integrity Types .....883
  - Database Integrity Perms .....884
  
- Chapter 35 Discussions .....893**
  - Discussion Types .....893
  - Properties .....893
  - Iterators .....896
  - Operations .....897
  - Triggers .....901
  - Discussions access controls .....902
  - Example .....904

<b>Chapter 36</b>	<b>General functions . . . . .</b>	<b>907</b>
	Error handling . . . . .	907
	Archive and restore . . . . .	910
	Checksum validation . . . . .	923
	Locking . . . . .	927
	HTML functions . . . . .	934
	HTTP Server . . . . .	936
	Asynchronous HTTP requests . . . . .	941
	OSLC DXL Services . . . . .	945
	Broadcast Messaging . . . . .	947
	Converting a symbol character to Unicode . . . . .	948
	Timer . . . . .	949
<b>Chapter 37</b>	<b>Character codes and their meanings . . . . .</b>	<b>953</b>
<b>Chapter 38</b>	<b>Notices . . . . .</b>	<b>959</b>
	<b>Index . . . . .</b>	<b>961</b>

# About this manual

Welcome to version 9.6.1 of IBM® Rational® DOORS®, a powerful tool that helps you to capture, track and manage your user requirements.

DXL (DOORS eXtension Language) is a scripting language specially developed for Rational DOORS. DXL is used in many parts of Rational DOORS to provide key features, such as file format importers and exporters, impact and traceability analysis and inter-module linking tools. DXL can also be used to develop larger add-on packages such as CASE tool interfaces and project management tools. To the end user, DXL developed applications appear as seamless extensions to the graphical user interface. This capability to extend or customize Rational DOORS is available to users who choose to develop their own DXL scripts.

The DXL language is for the more technical user, who sets up programs for the end-user to apply. DXL takes many of its fundamental features from C and C++. Anyone who has written programs in these or similar programming languages should be able to use DXL.

This book is a reference manual for DXL for version 9.6.1 of Rational DOORS. Refer to it if you wish to automate simple or complex repetitive tasks, or customize your users' Rational DOORS environment. It assumes that you know how to write C or C++ programs.

---

## Typographical conventions

The following typographical conventions are used in this manual:

Typeface or Symbol	Meaning
<b>Bold</b>	Important items, and items that you can select, including buttons and menus: “Click <b>Yes</b> to continue”.
<i>Italics</i>	Book titles.
Courier	Commands, files, and directories; computer output: “Edit your <code>.properties</code> file”.
>	A menu choice: “Select <b>File &gt; Open</b> ”. This means select the <b>File</b> menu, and then select the <b>Open</b> option.

Each function or macro is first introduced by name, followed by a declaration or the syntax, and a short description of the operation it performs. These are supplemented by examples where appropriate.

---

## Related documentation

The following table describes where to find information in the Rational DOORS documentation set:

<b>For information on</b>	<b>See</b>
Rational DOORS	The Rational DOORS Information Center
How to set up licenses to use Rational DOORS	<i>Rational Lifecycle Solutions Licensing Guide</i>
How to write requirements	<i>Get It Right the First Time</i>
How to integrate Rational DOORS with other applications	<i>Rational DOORS API manual</i>



## Chapter 1

# Introduction

This chapter describes the DXL Interaction window, DXL library, and the basic features of DXL. It covers the following topics:

- Developing DXL programs
- Browsing the DXL library
- Localizing DXL
- Language fundamentals
- Lexical conventions
- Constants
- Identifiers
- Types
- Declarations
- Expressions
- Statements
- Basic functions

---

## Developing DXL programs

You can use the DXL Interaction window to develop small DXL programs.

For large-scale program development, you should use a third party editing tool when coding, and then load your code into the DXL Interaction window to execute and debug it. You can set up a menu option in Rational DOORS to run your third party editing tool.

**To use the DXL Interaction window:**

1. In either the Database Explorer or a module window, click **Tools > Edit DXL**.

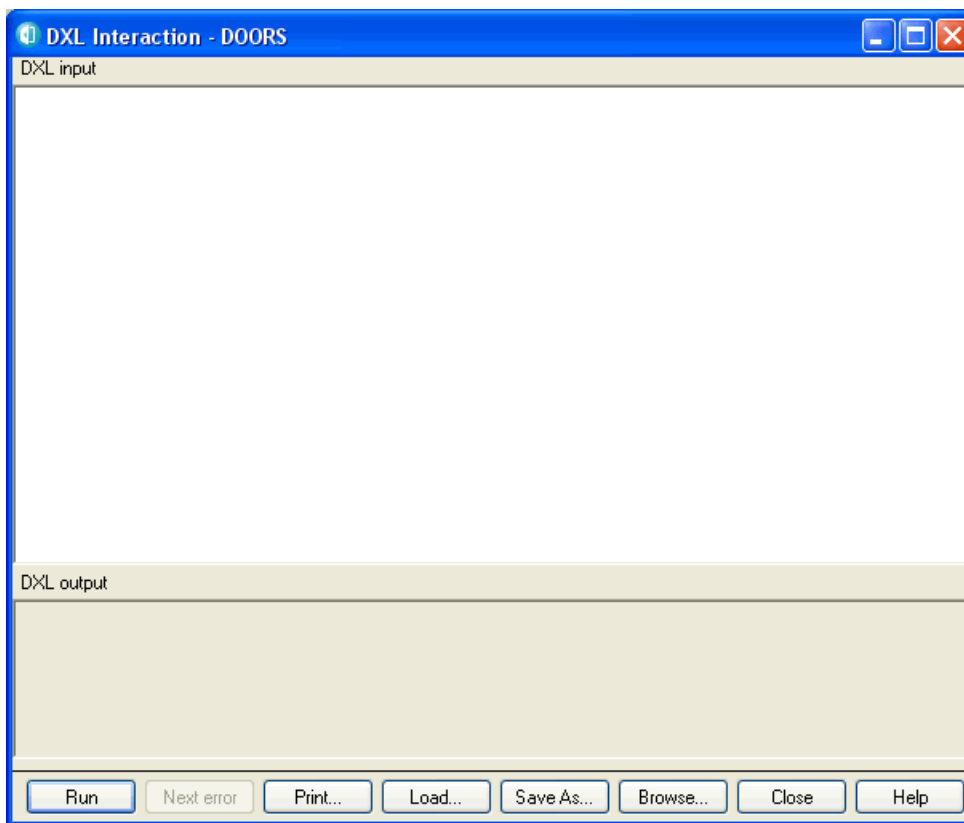

2. Either type or load your program into the DXL input pane.  
To load the contents of a file, click **Load**. To load a program from the DXL library, click **Browse**.
3. To run the program in the DXL input pane, click **Run**.  
Any error messages that are generated are displayed in the DXL output pane.  
To see the next error message, click **Next error**. The contents of the DXL input pane scroll to the line of source code that caused the error displayed in the DXL output pane.
4. To print the contents of the DXL input pane with line numbers, click **Print**.
5. To save the contents of the DXL input pane to file, click **Save As**.

Right-click anywhere in the DXL input pane to display a pop-up menu with the sub-menus **File**, **Edit**, and **Search**. The **Edit** sub-menu options have standard Windows functions. The **File** sub-menu options are described in the following table:

File	Description
Load	Loads the contents of a text file into the DXL input pane. You can also use drag-and-drop to load a file directly from Windows Explorer.
Save	Saves changes you made to the text in the DXL input pane.
Save as	Saves the contents of the DXL input pane to another file.
New	Clears the DXL input pane. If you have made changes to the text that have not yet been saved, you are asked if you want to save them.

The **Search** sub-menu options are described in the following table:

Search	Description
Search	Finds a string of text in the DXL input pane. The search is case-sensitive.
Again	Repeats the search.
Replace	Replaces one string of text with another. You can replace text strings one at a time or all at once.
Goto line	Moves the cursor to the start of a specified line. (This is useful when debugging DXL programs because errors are indicated against line numbers.)

---

## Browsing the DXL library

The DXL library is in the `/lib/dx1` folder in the Rational DOORS home directory.

You can browse the DXL library when you are:

- Using the DXL Interaction window, by clicking the **Browse** button to find a program to run.
- Creating a DXL attribute, by clicking the **Browse** button to find a program to use for the attribute (see “DXL attribute,” on page 463).
- Creating a layout DXL column, by clicking the **Browse** button to find a program to use for the layout DXL column (see “Layout DXL,” on page 696).

You see the DXL Library window. The DXL programs and the buttons you see depend on where you were when you clicked the **Browse** button.

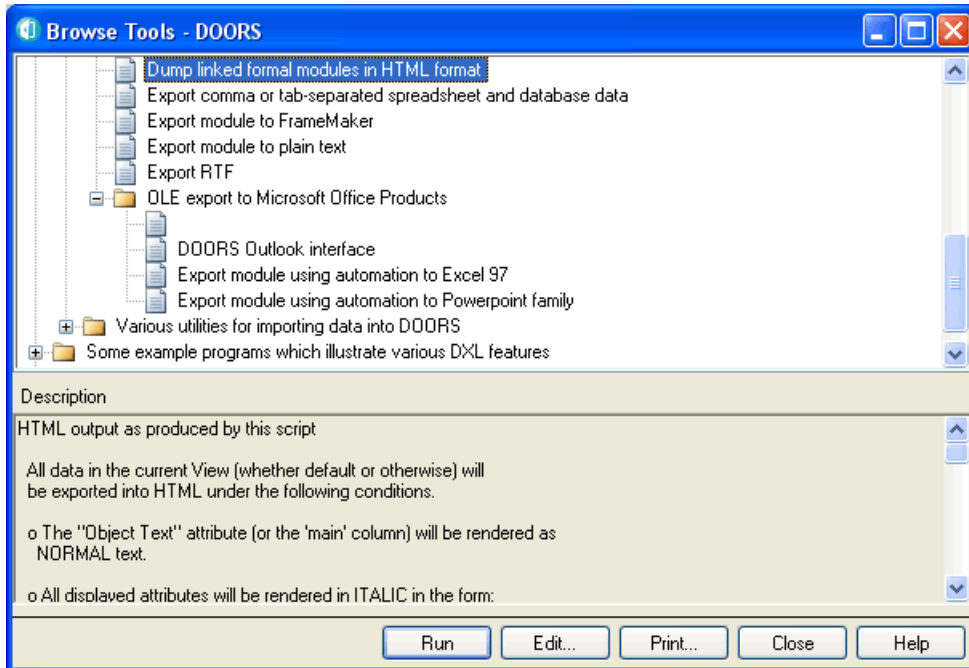

Button	Action
Run	Runs the selected program in your DXL Interaction window.
Edit	Edits the selected program.
Print	Prints the selected program.

## Localizing DXL

Rational DOORS uses ICU resource bundles for accessing translated strings. DXL perms are available to access ICU resource bundles containing translated strings for customized DXL. For information about creating ICU resource bundles, see <http://userguide.icu-project.org/locale/localizing>.

Put the language resource files in a directory whose name is taken as the *bundle name*, under  $\$DOORSHOME/language$ , for example  $\$DOORSHOME/language/myResource/de_DE.res$ . There are two bundles already shipped with Rational DOORS, *core* and *DXL*.)

---

## LS\_

---

### Declaration

```
string LS_(string key, string fallback, string bundle)
```

### Operation

Returns the string from resource bundle that is identified by key. If the string identified by key is not found in the resource bundle, the fallback string is returned.

### Example

de.txt file contains;

```
de {  
    Key1{"Ausgehend"}  
    Key2{"Ausgehende Links"}  
    Key3{"Normalansicht"}  
    Key4{"Klartext"}  
}
```

From the command line, generate a resource bundle, for example `genrb de.txt`, and copy the resource bundle to `$DOORSHOME/language/myResource/`, where *myResource* is the name of your resource bundle. The localized strings can then be accessed using the `LS_` perm, for example in the DXL editor, type:

```
print LS_("Key1", "Ausgehend not found", "myResource") "\n"  
print LS_("Key2", "Ausgehende Links not found", "myResource") "\n"  
print LS_("Key3", "Normalansicht not found", "myResource") "\n"  
print LS_("Key4", "Klartext not found", "myResource") "\n"
```

The output is:

```
Ausgehend  
Ausgehende Links  
Normalansicht  
Klartext
```

---

## Language fundamentals

DXL is layered on an underlying programming language whose fundamental data types, functions and syntax are largely based on C and C++. To support the needs of script writing, there are some differences. In particular, concepts like main program are avoided, and mandatory semicolons and parentheses have been discarded.

---

## Auto-declare

---

In DXL there is a mechanism called auto-declare, which means that a user need not specify a type for a variable. For example, in the script:

```
i=5
print i
```

the interpreter declares a new variable and deduces from the assignment that its type is `int`.

Because DXL is case-sensitive, there is a potential hazard when relying on this mechanism to type variables. If you make a mistake when typing a variable name, the interpreter assumes that a new variable is being used, which creates errors that are hard to find.

This feature can be disabled by adding the line:

```
XFLAGS_ &=~AutoDeclare_
```

to the bottom of the file `$DOORSHOME/lib/dxl/startup.dxl`.

---

## Syntax

---

The syntactic style is more like natural language or standard mathematical notation. Consider the function:

```
string deleteUser(string name)
```

This can be called as follows:

```
deleteUser "Susan Brown"
```

The lack of semicolons is possible through DXL's recognition of the end of a line as a statement terminator, except when it follows a binary operator. This means you can break an expression like `2+3` over a line by making the break after the `+` sign. A comment ending in a dash (`//-`) also enables line continuation.

As in C, `==` is used for equality, while `=` is used for assignment. Unlike C or Pascal, concatenation of symbols is a valid operation.

---

## Parsing

---

Statement or expression parsing is right associative and has a relatively high precedence. Parenthesis has the highest precedence.

Because `sqrt` is defined as a function call that takes a single type real argument:

```
sqrt 6.0
```

is recognized as a valid function call, whereas in C it is:

```
sqrt(6.0)
```

So, the C statement:

```
print(sqrt(6.0))
```

can be:

```
print sqrt 6.0
```

in DXL.

The following script declares a function `max`, which takes two type `int` arguments:

```
int max(int a, b) {
    if a < b then return b else return a
}
```

```
print max(2, 3)
```

The call of `max` is parsed as `print (max (2, 3) )`, which is valid. The statement:

```
print max 2,3
```

would generate errors. Because the comma has a lower precedence than concatenation, it is parsed as:

```
((print max(2)), 3)
```

If in doubt, use the parentheses, and separate statements for concatenation operations.

## Naming conventions

As a general rule, DXL reserves identifiers ending in one or more underscores (`_`, `__`) for its own use. You should not use functions, data types or variables with trailing underscores, with the exception of those documented in this manual.

Names introduced as data types in DXL, such as `int`, `string`, `Module` and `Object`, must not be used as identifiers. The fundamental types such as `int` and `string` are in lower case. Rational DOORS specific types all start with an upper case letter to distinguish them from these, and to enable their lower case versions to be used as identifiers.

## Loops

In DXL, loops are treated just like any other operator, and are **overloaded**, that is, declared to take arguments and return values of more than one type. The loop notation used is as follows:

```
for variable in something do {
    ...
}
```

The for loops all iterate through all values of an item, setting variable to each value in turn.

**Note:** When using for loops, care must be taken when deleting items within the loop and also opening and closing items within a for loop. For example, if *variable* is of type `Module` and *something* is of type `Project`, and within the for loop a condition is met that means one of the modules will be deleted, this should not be done within the for loop as it can lead to unexpected results. A recommended method is to use a skip list to store the modules and to do any manipulation required using the contents of the skip list.

---

## Lexical conventions

---



---

### Semicolon and end-of-line

---

DXL diverges from C in that semicolons can be omitted in some contexts, with end-of-line (**newline**) causing statement termination. Conversely, newline does not cause statement termination in other contexts. This is a useful property; programs look much better, and in practice the rules are intuitive. The rules are:

- Any newlines or spaces occurring immediately after the following tokens are ignored:

```

;      ,      ?      :      =      (      +      *      [
&      -      !      ~      /      %      <<      >>      <>
<      >      <=     >=     ==     !=     ^      |      &&
and    ||     or     ^^     +=     -=     *=     /=     %=
<<=    >>=    &=     |=     ^=     <-     :=     =>     ..
.      ->     ::     \

```

- Any newlines before an `else` or a `)` are ignored. All other newlines delimit a possibly empty statement.
- Multiple consecutive areas of white space containing newlines are treated as single newlines.
- The recognition of a newline can be avoided by prefixing it with an empty `//` comment or a comment ending in `-`.

---

### Comments

---

The characters `/*` start a comment that terminates with the characters `*/`. This style of comment does *not* nest.

The characters `//` start a comment that terminates at the end of the line on which it occurs. The end-of-line is not considered part of the comment unless the comment is empty or the final character is `-`. This latter feature is useful for adding comments to a multi-line expression, or for continuing a concatenation expression over two lines.

Notably, comments that immediately follow conditional statements can cause code to behave unexpectedly.

The following program demonstrates some comment forms:

```

/* Some comment examples (regular C comment) */
int a          // a C++ style comment
int b = 1 +    // We need a trailing - at the end      -
              2    // to prevent a syntax error between "+" and the newline
print //
    "hello" // the // after print causes the following newline to be
            // ignored
/*

```



```
{
  int C      // this whole block is commented out
}
*/
```

## Identifiers

An identifier is an arbitrarily long sequence of characters. The first character must be a letter; the rest of the identifier may contain letters, numerals or either of the following two symbols:

`_` `'`

DXL is case sensitive (upper- and lower-case letters are considered different).

The following words are reserved for use as keywords, and must not be used otherwise:

```
and      bool      break      by      case      char
const    continue  default    do      else      enum
for      if          in         int     module    object
or       pragma     real       return  sizeof    static
struct   string     switch     then    union     void
while
```

The following keywords are not currently supported in user programs, but are reserved for future use:

```
case      const      default    enum
struct    switch     union
```

A keyword is a sequence of letters with a fixed syntactic purpose within the language, and is not available for use as an identifier.

## File inclusion

To include files into DXL scripts, you can use either of the following:

```
#include "file"
#include <file>
```

Absolute or relative path names can be used. Relative paths must be based on one of the following forms depending on the platform:

```
$DOORSHOME/lib/dx1      (UNIX)
$DOORSHOME\\lib\\dx1    (Windows)
```

where `DOORSHOME` is defined in a UNIX<sup>®</sup> environment variable, or on Windows platforms in the registry. The Windows-style file separator (`\`) must be duplicated so that DXL does not interpret it as a meta-character in the string.

If the `addins` directory is defined in a UNIX environment variable or the Windows registry, this directory is also searched, so relative path names can be with respect to the `addins` directory.

**Note:** The UNIX shell file name specification form `~user/` is not supported.

## Pragmas

Pragmas modify the background behavior of the DXL interpreter, for example:

```
pragma runLim, int cyc
```

sets the timeout interval `cyc` as a number of DXL execution cycles. The timeout is suppressed if `cyc` is set to zero, as shown in the following example:

```
pragma runLim, 0           // no limit
pragma runLim, 1000000    // explicit limit
```

There is also a pragma for setting the size of the DXL runtime stack, which is used as follows:

```
pragma stack, 10000
```

The default value is set to 1,000,000.

If running the DXL from the DXL editor, when the timeout limit is reached a message is displayed asking if you want to:

- Continue - script execution continues with the same timeout limit.
- Continue doubling the timeout - script execution continues with double the current timeout limit.
- Halt execution - DXL is halted with a run-time error.

If running in batch mode, it is good practise to execute scripts in the DXL editor initially to detect any errors or timeouts. `Pragma runLim,0` should be used in instances of timeouts.

## Constants

### Integer constants

An integer constant consisting of a sequence of digits is interpreted as octal if it begins with a 0 (digit zero); otherwise it is interpreted as decimal.

A sequence of digits preceded by `0x` or `0X` is interpreted as a hexadecimal integer.

A sequence of 0s or 1s preceded by `0b` is interpreted as a binary number, and converted to an integer value.

---

## Character constants

---

A character constant is a character enclosed in single quotes, as in `'x'`. The value of a character constant is defined to be of type `char`.

Certain non-graphic characters, the single quote and the backslash, can be represented according to the following escape sequences:

Character	Escape sequence
newline	<code>\n</code>
horizontal tab	<code>\t</code>
backspace	<code>\b</code>
carriage return	<code>\r</code>
form-feed	<code>\f</code>
backslash	<code>\\</code>
single quote	<code>\'</code>
bit pattern	<code>\ddd</code>
any other character	<code>\c</code>

The escape `\ddd` consists of the backslash followed by 1, 2, or 3 octal digits.

Any other character that is escaped is passed straight through.

---

## Type real constants

---

A type `real` consists of an integer part, a decimal point, a fraction part, an `e` or `E`, and an integer exponent. The integer and fraction part both consist of a sequence of digits.

You can omit either the integer part or the fraction part, but not both. You can omit either the decimal point or the exponent with its `e` or `E`. You can add a sign to the exponent.

### Example

`1.0`

`0.1`

`1e10`

`1.2E30`

---

## The null constant

---

The constant `null` is used as a polymorphic value to indicate a null value. You can use it for any derived type (see “Derived types,” on page 15). You can use it for both assignment to variables and conditional tests on variables.

### Example

```
Object obj = null
if (null obj) {
    ack "This object is empty"
}
```

---

## Strings

---

A string literal, of type `string` and storage class `static`, is a sequence of characters surrounded by double quotes, as in `"apple"`.

Within a string the double quote (") must be preceded by a backslash (\). For example `"Pear\""` is the string `Pear"` in quotes. In addition, you can use the same escape sequences as described in “Character constants,” on page 13, including the newline character.

---

## Identifiers

---

Identifiers denote variables, functions, types and values. You can introduce an identifier into a program by declaration or by immediate declaration. Immediate declaration is when an undeclared identifier is used as the left hand side of an assignment statement.

---

## Variables

---

Variables represent regions of computer memory. The meaning of the value stored in a variable is determined by the type of the identifier used to access the variable.

Unassigned variables contain the unassigned pattern, which is checked on all references. In this way, errors with unassigned variables are avoided, and an accurate error message is reported.

---

## Scope

---

Once declared, an identifier has a region of validity within the program known as its `scope`.

In general, identifiers are in scope following their declaration within the current block, and are available within nested blocks. Identifiers can be hidden by re-declaration in nested blocks. For example, the following code prints a 4 and then a 3 in the output pane of the DXL Interaction window.

```
int i = 3
```

```

if (true){
    int i = 4
    print i "\n"
}
print i "\n"

```

---

## Types

---

### Fundamental types

---

DXL has the following base types:

Base type	Description
<code>bool</code>	Denotes the domain of values <code>true</code> and <code>false</code> , which are provided as predefined constants.
<code>char</code>	Is similar to the C character type.
<code>int</code>	Is the only integer type provided in DXL. On all platforms, integers are signed, and have a precision of 32 bits.
<code>real</code>	Is like the double type in C, with a precision of 64 bits.
<code>void</code>	Is the type with no values; its main use is in declaring functions that do not return a result.
<code>string</code>	Is similar to the derived C type <code>char*</code> .

---

### Derived types

---

DXL supports arrays, functions and references. An internal class facility provides new non-fundamental types, referred to as **built-in** types, such as `Object`, `Module` and `Template`. DXL does not support class creation by user programs.

---

## Declarations

Declarations are the mechanism used to associate identifiers with variables, functions or values.

---

### Declarators

---

DXL follows C in its declarator syntax. However, only the simple forms should be necessary in DXL programs.

DXL extends C style arrays by enabling a variable to define the bounds of the array. The number of elements in an array is available by using the `sizeof` function.

Unlike C, DXL arrays can have only one dimension.

In addition to the normal C declarator forms, DXL provides the C++ reference declarator `&`.

DXL uses the ANSI C method of supplying a function's formal parameters in the declarator itself with each argument given as a fully specified type.

The following script gives some example declarations:

```
int i, j, k      // declare 3 integers
int n = 4       // declare an integer and initialize it
bool a[2]       // declare an array of type bool of size 2
int b[n]        // declare an integer array of size n
print sizeof a // prints "2"
```

**Note:** A declaration of the form `'int n = {1,2,3}'` is not supported.

## Immediate declaration

Immediate declaration is a DXL extension from C, which means that the first use of an undeclared variable is also a declaration. It must be used in a context where an unambiguous value is given to it, for example the left hand side of an assignment statement:

```
i = 2
print i
```

Once declared, the identifier must be used consistently.

## Function definitions

DXL functions are very close to the style of ANSI C functions. The following script gives some examples:

```
// define a function to find the maximum of two integers
int i
int max(int a, b) {
    return a < b ? b : a
} // max

// This function applies f to every element in a,
// using an accumulation variable r that is initialized to base.
int apply_accumulate(int base, int a[], int f(int, int)) {
    int r = base
    for (i = 0; i < sizeof a; i++) {
        r = f(r, a[i])
    }
}
```

```

        return r
    } // apply_accumulate
int a[5]
print "Filling an array:\n\n"
for (i = 0; i < sizeof a; i++) {
    a[i] = random 1000
    print a[i] "\n"
} // for
print "largest number was: "
print apply_accumulate(0, a, max)
// print largest element in a

```

Line 3 defines the function `max`, which has two parameters of type `int` and returns a type `int`. One difference from ANSI C is that the parameter type specifier `int` need not be repeated before the `b` parameter.

Line 10 declares a function parameter `f`. Note that `f`'s parameters do not include redundant identifiers.

## Operator functions

You can redefine DXL operators by prefixing the operator with `::` to turn it into an identifier.

### Example

This example defines a multiplication operator that applies to strings and integers.

```

string ::*(string s, int n) {
    string x = ""
    int i
    for i in 0 : n-1 do {
        x = x s
    }
    return x
}
print ("apple " * 4)

```

This prints out:

```
apple apple apple apple
```

If you wish to overload the concatenation operator, which is normally represented by a space, use the symbol `::..`

```

string ::..(real r, int n) {
    string s = ""
    int i
    // concatenate the string to a space n times
}

```

```

    for i in 0:n-1 do {
        s=s r " "
    }
    return s
}
print (2.45 3) "\n"           // try it out
The program prints the string:
2.450000 2.450000 2.450000

```

---

## Expressions

This section outlines the major differences between C and DXL expressions. The operations defined on DXL fundamental types are explained in “Fundamental types and functions,” on page 113.

---

## Reference operations

DXL supports C++ style reference operations. References are like `var` parameters in Pascal or Ada, which means they provide an alias to a variable, not a copy. To declare a reference variable its name must be preceded by an ampersand (&).

### Example

This example is a program to swap two integers. In C you have explicitly to pass the address of the variables to be swapped and then de-reference them within the body of the function. This is not required in DXL.

```

// swap two integers
void swap (int &a, &b) {
    int temp
    temp = a; a = b; b = temp
}
int x = 2
int& z = x           // z is now an alias for x
int y = 3
print x " " y "\n"
swap(z, y)          // equivalent to swap(x,y)
print x " " y "\n"

```

This program prints the string:

```

2 3
3 2

```



---

## Overloaded functions and operators

---

Most functions and operators can be declared to take arguments and return values of more than one type.

### Example

This example overloads a commonly used identifier `print` to provide an object printer.

```
// Overload print to define an Object printer
void print(Object o) {
    string h = o."Object Heading"
    string t = o."Object Text"
    print h ":\n\n" t "\n"
}
print current Object
```

---

## Function calls

---

DXL enables calls of functions defined without parameters to omit the empty parenthesis, except where the call appears as a function argument or any other context where a function name is valid. Function calls with single arguments can also omit the parenthesis, but beware of concatenation's high precedence when the argument passed is an expression.

**Note:** When overloading functions, ensure that the first declaration of the function does not have a void parameter, e.g `void print(void)`. This may lead to unexpected results. Furthermore, function calls of the form `void print(int i=0, int g=0)` should also not be used.

### Example

```
void motto() {           // parameterless
    print "A stitch in time saves nine.\n"
} // motto
int square(int x) {
    return x*x
} // square
motto                   // call the function
print square 9          // two function calls
```

---

## Casts

---

Because of DXL's overloading facility, it is easy to write expressions that have more than one possible interpretation; that is, they are ambiguous. **Casts** are used to pick which interpretation is required. Casts in DXL come in two forms:

```
expression type
```

(type expression)

In the first form, the type name can appear after the expression, as in:

```
o = current Object
```

In the second form, the type may come first, but the whole expression must be within parenthesis:

```
o = (Object current)
```

## Range

A range expression extracts a substring from a string, or substring from a buffer, and is used in regular expression matching. It has two forms:

```
int from : int to
```

```
int from : int to by int by
```

Examples are given with the functions that use ranges.

## Statements

This section describes how to construct statements in DXL.

### Compound statements

Compound statements are also referred to as **blocks**.

Several statements can be grouped into one using braces { . . . }.

### Conditional statements

The `if` statement takes an expression of type `bool`, which must be in parenthesis. If the expression evaluates to `true`, it executes the following statement, which can be a block. If the expression evaluates to `false`, an optional `else` statement is executed.

As an alternative form, the parenthesis around the condition can be dropped, and the keyword `then` used after the condition.

#### Example

```
int i = 2, j = 2
if (i < 3) {
    i += 2
} else {
    i += 3
}
```

```
if i == j then j = 22
```

The then form does not work with a condition that starts with a component in parenthesis, for example:

```
if (2 + 3) == 4 then print "no"
```

generates a syntax error.

DXL also supports the C expression form:

```
2 + 3 == 5 ? print "yes" : print "no"
```

The if statement also supports multiple `else if` statements, which can be written as `elseif`.

## Example

```
int i = 1, j = 2

if (i < j) {
    i += 3
} else if (i == j) {
    i += 2
{ else if (i > j) {
    i += 1
}
```

Do not add a comment in the middle of the `else if` statement.

## Example

```
int i = 1, j = 2

if (i < j) {
    i += 3
} else
    // Do not add comment here
if (i == j) {
    i += 2
```

```
{ else if (i > j) {
    i += 1
}
```

DXL considers the `else if` to be one statement and can give incorrect results if a comment line with a preceding space or tab is in-between the `else` and `if`.

---

## Loop statements

---

DXL has three main loop (iteration) statements. It supports the C forms:

```
for (init; cond; increment) statement
```

```
while (cond) statement
```

and a new form:

```
for type1 v1 in type2 v2 do
```

where *type1* and *type2* are two types, possibly the same; *v1* is a reference variable and *v2* is a variable, which can be a range expression (see “Range,” on page 20). This form is heavily used in DXL for defining type-specific loops.

### Example

```
int x
int a=2
int b=3
for (x=1; x <= 11; x+=2) {
    print x
}
while (a==2 and b==3) {
    print "hello\n";
    a = 3
}
for x in 1 : 11 by 2 do {
    print x
}
```

In this example, the first loop is a normal C `for` loop; the second is a normal C `while` loop. Note that DXL offers the keyword `and` as an alternative to `&&`.

The last form in the example uses a range statement, which has the same semantics as the first C-like loop.

---

## Break statement

---

The `break` statement causes an immediate exit from a loop. Control passes to the statement following the loop.

### Example

```
int i = 1
```

```

while (true){
    print i++
    if (i==10){
        break
    }// if (i==10)
}// while (true)

```

---

## Continue statement

---

The continue statement effects an immediate jump to the loop's next test or increment statement.

### Example

```

int i = 1
while (true){
    if (i==4) { // don't show 4
        i++
        continue
    }// if (i==4)

    print i++

    if (i==10){
        break
    }// if (i==10)
}// while (true)

```

---

## Return statement

---

The return statement either exits a void function, or returns the given value in any other function.

**Note:** Care should be taken when using the return statement. For example, assigning a value to a variable where the assignment is a function, and that function returns no value, can lead to unexpected values being assigned to the variable.

### Example

```

// exit void function
void print(Object o) {
    if (null o)
        return string h = o."Object Heading"
    print h "\n"
} // print
// return given value

```

```
int double(int x) {
    return x + x    // return an integer
} // double
print double 111
```

---

## Null statement

---

The null (empty) statement has no effect. You can create a null statement by using a semicolon on its own.

### Example

```
int a = 3
if (a < 2) ; else print a
```

---

## Basic functions

This section defines some basic functions, which can be used throughout DXL.

---

### of

---

This function is used as shown in the following syntax:

```
of(argument)
```

Returns the passed argument, which can be of any type. It has no other effect. It is used to clarify code.

### Example

```
if end of cin then break
```

---

### sizeof

---

This function is used as shown in the following syntax:

```
sizeof(array[])
```

Returns the number of elements in the array, which can be of any type.

### Example

```
string strs[] = {"one", "two", "three"}
int ints[] = {1, 2, 3, 4}
print sizeof strs    // prints 3
print sizeof ints    // prints 4
```

---

## halt

---

### Declaration

```
void halt()
```

### Operation

Causes the current DXL program to terminate immediately. This is very useful if an error condition is detected in a program.

### Example

```
if (null current Module) {
    ack "program requires a current module"
    halt
}
```

---

## checkDXL

---

### Declaration

```
string checkDXL[File] (string code)
```

### Operation

Provides a DXL mechanism for checking DXL code.

The `checkDXL` function analyzes a DXL program and returns the string that would have been produced in the DXL Interaction window had it been run on its own.

The `checkDXLFile` function analyzes a file and returns the error message that would have been produced in the DXL Interaction window had the file been run.

### Example

```
string errors =
    checkDXL("int j = 3 \n print k + j")
if (!null errors)
    print "Errors found in dxl string:\n" errors
        "\n"
```

would produce the following in the DXL Interaction window's output pane.

Errors found in dxl string:

```
-E- DXL: <Line:2> incorrect arguments for (+)
-E- DXL: <Line:2> incorrect arguments for function (print)
-E- DXL: <Line:2> undeclared variable (k)
```

---

## sort

---

### Declaration

```
void sort(string stringArray[])
```

### Operation

Sorts the string array *stringArray*. The sort function handles string arrays containing non-ASCII characters, as do the string and Buffer comparison operators.

### Example

```
int noOfHeadings = 0
Object o
for o in current Module do {
    string oh = o."Object Heading"
    if (!null oh) noOfHeadings++
}
string headings[noOfHeadings]
int i = 0
for o in current Module do {
    string oh = o."Object Heading"
    if (!null oh) headings[i++] = oh
}
sort headings
for (i = 0; i < noOfHeadings; i++) print headings[i] "\n"
```

---

## activateURL

---

### Declaration

```
void activateURL(string url)
```

### Operation

This is equivalent to clicking on a URL in a formal module.

---

## batchMode, isBatch

---

### Declaration

```
bool batchMode()
bool isBatch()
```



## Operation

Both functions return `true` if Rational DOORS is running in batch mode, and `false` if Rational DOORS is running in interactive mode.



## Chapter 2

# New in DXL for Rational DOORS 9.6.1

This chapter describes changes to the DXL Reference Manual in Rational DOORS 9.6.1:

- Object Management functions:
  - `purgeObject_`
- Dialog box functions:
  - `helpOn`
  - `minimumSize`
  - `listView`
- Display control functions:
  - Compound filters
  - Columns: `backgroundColor(get)`
  - Columns: `backgroundColor(set)`
  - Layout DXL: `setRefreshDelta`
- OLE objects
  - `oleInsert` (insert to buffer)
- General functions:
  - Checksum validation
  - HTML help
  - Asynchronous HTTP requests
  - OSLC DXL Services
  - Timer
- Triggers

---

## Object Management functions

---

### `purgeObject_`

---

The function “`purgeObject_`” on page 384 removes the specified soft-deleted object. Once executed, this object cannot be recovered. The name ends in ‘`_`’ to discourage casual use. The documentation for this function is added in version 9.6.1.3 of this manual.

---

## Module Properties

---

### delete(ModuleProperties)

---

The function “delete(ModuleProperties)” on page 347 deletes the supplied moduleProperties structure. If not called after a call to getProperties, the memory will only be released after the context is released. This function is new in Rational DOORS version 9.6.1.4.

---

## Dialog box functions

---

### helpOn

---

The documentation for the helpOn function has been removed from this manual because the help is no longer delivered in the HTML Help (chm) format.

### minimumSize

---

The new function “minimumSize” on page 498 sets the minimum size of the dialog box to a specified width and height.

### listView

---

Beginning in Rational DOORS version 9.6.1.7, you can use Ctrl+A keys to select all items in a multiselect listView. See “listView” on page 545.

---

## Display control functions

---

### Compound filters

---

The documentation for “Compound filters” on page 654 includes new example code in version 9.6.1.3 of this manual.

---

## Columns: backgroundColor(get)

---

The function “backgroundColor(get)” on page 687 returns the name of the attribute that is used to color the background of a specific column. The function was first included in version 9.4.0. The documentation is added in version 9.6.1.3 of this manual.

---

## Columns: backgroundColor(set)

---

The function “backgroundColor(set)” on page 688 sets the background color of a specific column. The function was first included in version 9.4.0. The documentation is added in version 9.6.1.3 of this manual.

---

## Layout DXL: setRefreshDelta

---

The function “setRefreshDelta” on page 700 was a new function in Rational DOORS 9.6.0. The documentation is added in version 9.6.1 of this manual.

---

# OLE objects

---

---

## oleInsert (insert to buffer)

---

The function “oleInsert (insert to buffer)” on page 738 inserts OLE into the given buffer at a given character offset. The documentation for this function is added in version 9.6.1.4 of this manual.

---

# General functions

---

---

## Checksum validation

---

The checksum validation functions enable you to create a validation record for a module before you export or archive the module. When the module is later imported or restored to the project, you can compare the checksum validation record with the module to identify changes to the text or other attribute values in the selected views.

---

## createChecksumFile

---

The function “createChecksumFile” on page 923 creates a compressed file with a .zip extension that contains XML files that describe a module, selected views within the module, and object attributes that are associated with objects in those views.

---

## loadChecksumFile

---

The function “loadChecksumFile” on page 924 loads a checksum package for a specific module and loads the list of views that are available for checksum comparison.

---

## compareChecksumFile

---

The function “compareChecksumFile” on page 925 enables the user to compare the checksum validation record with the related module to identify changes to the text or other attribute values in the selected views.

---

## HTML help: helpOnEx

---

The documentation for the helpOnEx function has been removed from this manual because the help is no longer delivered in the HTML Help (chm) format.

---

## Asynchronous HTTP requests

---

The “Asynchronous HTTP requests” on page 941 are used to make HTTP requests asynchronously so that the main Rational DOORS process is not blocked. With these functions, the DXL user interface is still be responsive while an HTTP request is in progress.

### Future HttpRequest

The Future HttpRequest function starts an HTTP request but instead of waiting for a response, it immediately returns a Future object. The Future object contains a value that will be delivered in future. The Future object can be checked for readiness later. The HTTP response can be fetched from the Future object when it is ready.

The documentation for this function is added in version 9.6.1.6 of this manual.

---

## OSLC DXL Services

OSLC DXL Services are DXL scripts that can be run by making an Open Services for Lifecycle Collaboration (OSLC) request to an instance of Rational DOORS Web Access. A service must be added to the DOORS database before it can be run. DXL functions are available to add, remove, and return information about DXL services. For more information and examples, see the help topic: OSLC DXL services for Rational DOORS.

Support for OSLC DXL Services was added to Rational DOORS in a previous release. This documentation is added in version 9.6.1.4.

---

### OSLCDXLService properties

---

“OSLCDXLService properties” on page 945 are defined for use with the `.` (dot) operator and a `OSLCDXLService` handle.

---

### setDxlServiceResult

---

The function “setDxlServiceResult” on page 946 sets the result string that is returned as a result of the service that is being run.

---

### addOrUpdateOSLCDXLService

---

The function “addOrUpdateOSLCDXLService” on page 946 adds a new service to the list of configured DXL services or updates an existing one.

---

### removeOSLCDXLService(string key)

---

The function “removeOSLCDXLService(string key)” on page 947 removes a service from the configuration. Finds the service by its key (that is, name).

---

### removeOSLCDXLService(OSLCDXLService service)

---

The function “removeOSLCDXLService(OSLCDXLService service)” on page 947 removes a service object from the configuration.

---

# Timer

Documentation for the timer functions is added in version 9.6.1.4. The functions are available in earlier versions.

---

## timer

---

“Timer” on page 949 creates a timer element that executes the callback function every 'n' seconds.

---

## stopTimer

---

The function “stopTimer” on page 949 stops the execution of a specific timer. Returns true if the timer was running and is now stopped.

---

## startTimer

---

The function “startTimer” on page 949 restarts the execution of a specific timer. Returns true if the timer was stopped and is now restarted.

---

## isTimer

---

The function “isTimer” on page 950 returns TRUE if `i.d` is a valid action index and it is a timer.

---

## getTimerName

---

The function “getTimerName” on page 950 returns a string containing the name of the timer (or NULL if not a timer).

---

## getTimerInterval

---

The function “getTimerInterval” on page 950 returns the number of seconds between each execution of the timer.

---

## getTimerID

---

The function “getTimerID” on page 950 returns the timer `i.d` as an integer.

---

## getTimerRunning

---

The function “getTimerRunning” on page 951 returns TRUE if `i.d` is a timer and it is running.

---



---

## Triggers

The documentation for triggers is updated in version 9.6.1.6 to include this statement: Rational DOORS Web Access does not support triggers. This condition applies to all previous versions also.



## Chapter 3

# New in DXL for Rational DOORS 9.6

This chapter describes features and documentation that are new in Rational DOORS 9.6:

- Operating system interface: `getMemoryUsage`
- Mini database explorer
- Modules: `downgrade`, `downgradeShare`
- History constants
- Dialog box functions: common element operations
- Display control
  - Columns
  - Layout DXL: `setRefreshDelta`
- HTTP Server

---

## Operating system interface

---

### `getMemoryUsage`

---

This perm “`getMemoryUsage`” on page 178 returns the Rational DOORS client memory usage in MB.

The perm was added in Rational DOORS 9.3.0.7, but the documentation is new in 9.6.0.1.

---

## Mini database explorer

This perm “`fnMiniExplorer`” on page 198 creates a miniature database explorer window that shows a tree view in which you can navigate through the hierarchy of the Rational DOORS database and select an item.

This information is added to the documentation in Rational DOORS 9.6.0.1. The function is available in previous releases.

---

# Modules

---

---

## downgrade

---

This information is added to the documentation for the existing perm “downgrade” on page 299 in Rational DOORS 9.6.0.1:

If there are unsaved changes to the module, then the user is prompted to save the changes. Alternatively, the save perm can be used prior to downgrade, so that any changes to the module are preserved.

---

---

## downgradeShare

---

This information is added to the documentation for the existing perm “downgradeShare” on page 299 in Rational DOORS 9.6.0.1:

If there are unsaved changes to the module, then the user is prompted to save the changes. Alternatively, the save perm can be used prior to downgrade, so that any changes to the module are preserved.

---

---

# History

---

---

## Constants (history type)

---

The following constants are added to the list of “Constants (history type)” on page 331:

- `const HistoryType moveObject`
- `const HistoryType synchronizeModule`
- `const HistoryType commentModule`
- `const HistoryType commentObject`

This information is added to the documentation in Rational DOORS 9.6.0.1. The functions are available in previous releases.

---

## Dialog box functions: common element operations

---

### setTextChangeCB

---

This perm “setTextChangeCB” on page 508 sets the text change callback for field, richField, text, richText DBEs where the callback is of the form `void callbackFn (DBE)`. When the callback function is invoked on a text change, DBE will be the handle of the edit control DBE, which can be field, richField, text or richText.

This is a new function in Rational DOORS 9.6.

---

### toolBarEditGetString

---

This perm “toolBarEditGetString” on page 509 gets the contents of the edit control hosted on the toolbar with DBE handle *tb*, where *index* identifies the edit control on this toolbar by the index of the edit control.

This is a new function in Rational DOORS 9.6.

---



---

## Display control: columns

---

### link(get)

---

This perm “link(get)” on page 692 returns true if column *c* is a link indicator column.

This is a new function in Rational DOORS 9.6.

---

### link(set)

---

This perm “link(set)” on page 692 makes column *c* a link indicator column.

This is a new function in Rational DOORS 9.6.

---

### changebar(get)

---

This perm “changebar(get)” on page 692 returns true if column *c* is a change bar column.

This is a new function in Rational DOORS 9.6.

---

### changebar(set)

---

This perm “changebar(set)” on page 692 makes column *c* a change bar column.

---

This is a new function in Rational DOORS 9.6.

---

## currentColumn(get)

---

This perm “currentColumn(get)” on page 694 gets the current column for this DXL context. If the DXL is not layout DXL then this will return NULL.

This information is added to the documentation in Rational DOORS 9.6. The function is available in previous releases.

---

## Display control: Layout DXL

---

---

### setRefreshDelta

---

The function “setRefreshDelta” on page 700 is a new Layout DXL function in Rational DOORS 9.6. The documentation for this function is added in 9.6.1.

---

## HTTP Server

The new section “HTTP Server” on page 936 defines functions for making HTTP requests to a URL.

This information is added to the documentation in Rational DOORS 9.6. The functions are available in the most recent previous releases.

## Chapter 4

# New in DXL for Rational DOORS 9.5

This chapter describes features and documentation that are new in Rational DOORS 9.5:

- Embedded OLE objects and the OLE clipboard
- OSLC Link Discovery
- Database properties
- Rational Directory Server

---

## Embedded OLE objects and the OLE clipboard

---

### oleInsert

---

#### Declaration

```
bool oleInsert(Object o, [attrRef], string fileName, [bool insertAsIcon])
```

where the optional parameter *attrRef* is in the following format: (Object o).(string attrName)

#### Operation

Embeds the file *fileName* as an OLE object in the Rational DOORS formal object *o* in a text attribute. If the optional parameter *attrRef* is specified, then the OLE object is embedded in the user-defined text attribute. If no parameter is specified, then the OLE object is embedded in the system Object Text attribute.

If the optional parameter *insertAsIcon* is specified, then if *true*, the OLE object is displayed as an icon, else it is displayed as content. If no parameter is specified, then the default is to display the OLE object as content.

The function returns *true* on successful insertion of the OLE object. Otherwise, it returns *false*.

An OLE package is created if a file has no associated applications that support OLE. OLE packages even allow executable files to be embedded into documents. It is then possible to execute such a file from within the document.

#### Example

```
/*
this code segment embeds an existing word document into the current formal
object
*/
string docName = "c:\\docs\\details.doc"
Object obj = current
```

```

if (oleInsert(obj, obj."my_text", docName)){
    print "Successfully embedded document\n"
} else {
    print "Problem trying to embed document\n"
}

```

---

## OSLC Link Discovery

When OSLC (external) links are discovered the results are stored in DOORS in a database-wide cache so that future sessions that open modules with those links open faster. When a user opens a module, the cache is checked first for any external links. If the data in the cache has not yet expired then the cached external links are shown; else, a new query is executed to discover any OSLC (external) links and the cache is then updated with the results. The cache has a default expiry time of 5 minutes after which the external links are considered to be out of date. This expiry time can be modified.

---

### getCachedExternalLinkLifeTime

---

#### Declaration

```
int getCachedExternalLinkLifeTime()
```

#### Operation

Returns the life time (expiry time) of the cached external links in seconds.

---

### setCachedExternalLinkLifeTime

---

#### Declaration

```
string setCachedExternalLinkLifeTime(int lifetime)
```

#### Operation

Sets the life time (expiry time) of the cached external links to lifetime seconds.

If the value lifetime is zero then this will disable link discovery.

Returns an error if the user does not have the manage database privilege; otherwise, returns null.



---

## Database properties

---

---

### getReconfirmPasswordRequired

---

#### Declaration

```
bool getReconfirmPasswordRequired()
```

#### Operation

Returns *true* if a reconfirmation password is required after a specified timeout period; otherwise, returns *false*.

---

---

### setReconfirmPasswordRequired

---

#### Declaration

```
void setReconfirmPasswordRequired(bool required)
```

#### Operation

Sets whether a reconfirmation password is required after a specified timeout period, depending on the value of *required*.

This perm only operates if the current user has the Manage Database privilege.

---

---

### getReconfirmPasswordTimeout

---

#### Declaration

```
int getReconfirmPasswordTimeout()
```

#### Operation

Returns the timeout period (in minutes) before the reconfirmation password dialog appears.

---

---

### setReconfirmPasswordTimeout

---

#### Declaration

```
void setReconfirmPasswordTimeout(int timeout)
```

#### Operation

Sets the timeout period to *timeout* minutes before the reconfirmation password dialog appears.

This perm only operates if the current user has the Manage Database privilege.

---

---

## getRequireLettersInPassword

---

### Declaration

```
bool getRequireLettersInPassword()
```

### Operation

Returns *true* if a password is required to contain at least one alphabetic character; otherwise, returns *false*.

---

## setRequireLettersInPassword

---

### Declaration

```
string setRequireLettersInPassword(bool required)
```

### Operation

If *required* is true, then a password is required to contain at least one alphabetic character.

This perm only operates if the current user has the Manage Database privilege, otherwise an error message is returned.

---

## getRequireNumberInPassword

---

### Declaration

```
bool getRequireNumberInPassword()
```

### Operation

Returns *true* if a password is required to contain at least one number; otherwise, returns *false*.

---

## setRequireNumberInPassword

---

### Declaration

```
string setRequireNumberInPassword(bool required)
```

### Operation

If *required* is *true*, a password is required to contain at least one number.

This perm only operates if the current user has the Manage Database privilege, otherwise an error message is returned.

---

## getRequireSymbolInPassword

---

### Declaration

```
bool getRequireSymbolInPassword()
```

## Operation

Returns *true* if a password is required to contain at least one non-alphanumeric character; otherwise, returns *false*.

## setRequireSymbolInPassword

### Declaration

```
string setRequireSymbolInPassword(bool required)
```

### Operation

If *required* is *true*, a password is required to contain at least one non-alphanumeric character.

This perm only operates if the current user has the Manage Database privilege, otherwise an error message is returned.

## getMinPasswordGeneration

### Declaration

```
int getMinPasswordGeneration()
```

### Operation

Returns the minimum number of password generations before a password can be reused.

## setMinPasswordGeneration

### Declaration

```
string setMinPasswordGeneration(int num)
```

### Operation

Sets the minimum number of password generations before a password can be reused to *num*. The minimum number cannot exceed the in-built maximum limit of 12 generations before a password can be reused.

This perm only operates if the current user has the Manage Database privilege, otherwise an error message is returned.

## getMaxPasswordGenerationLimit

### Declaration

```
int getMaxPasswordGenerationLimit()
```

### Operation

Returns the in-built maximum limit of password generations before a password can be reused. This maximum limit is set to 12.

---

## getMinPasswordAgeInDays

---

### Declaration

```
int getMinPasswordAgeInDays()
```

### Operation

Returns the minimum number of days before a password can be reused.

---

## setMinPasswordAgeInDays

---

### Declaration

```
string setMinPasswordAgeInDays(int days)
```

### Operation

Sets the minimum number of days before a password can be reused to days. The minimum number cannot exceed the in-built maximum limit of 180 days before a password can be reused.

This perm only operates if the current user has the Manage Database privilege, otherwise an error message is returned.

---

## getMaxPasswordAgeLimit

---

### Declaration

```
int getMaxPasswordAgeLimit()
```

### Operation

Returns the in-built maximum limit of days before a password can be reused. This maximum limit is set to 180 days.

---

# Rational Directory Server

---

---

## getTDPortNo

---

### Declaration

```
int getTDPortNo()
```

### Operation

Returns the Rational Directory Server port number.

---

## setTDPortNo

---

### Declaration

```
string setTDPortNo(int i)
```

### Operation

Sets the Rational Directory Server port number.

Returns an error string if the current user is not the administrator.



## Chapter 5

# New in DXL for Rational DOORS 9.4

This chapter describes features that are new in Rational DOORS 9.4:

- Attribute definitions
- Attribute types
- Rich text strings

---

## Attribute definitions

---

### Attribute definition properties

---

Properties are defined for use with the `.` (dot) operator and an attribute definition handle to extract information from an attribute definition, as shown in the following syntax:

```
(AttrDef ad).property
```

The following property is now supported:

String property	Extracts
<code>uri</code>	The URI of an attribute definition.

---

### create(attribute definition)

---

#### Syntax

```
AttrDef create([module|object]
               [property value]...
               [(default defVal)]
               attribute(string attrName))
```

#### Operation

Creates a new attribute definition called `attrName` from the call to `attribute`, which is the only argument that must be passed to `create`. The optional arguments modify `create`, by specifying the value of attribute properties. The arguments can be concatenated together to form valid attribute creation statements.

The keywords `module` and `object` specify that the attribute definition that is being created applies to modules or objects, respectively.

The default property specifies the default value for the attribute definition that is being created as *defVal*. This property should always be specified within parenthesis to avoid parsing problems. The value must be given as a string, even if the underlying type is different. Rational DOORS converts the value automatically.

As required, you can specify other properties. The defaults are the same as the Rational DOORS user interface. The following property is now supported:

String property	Specifies
uri	The URI of an attribute definition.

---

## modify(attribute definition)

---

### Declaration

```
AttrDef modify(AttrDef old,
               [setProperty value,]
               AttrDef new)
```

### Operation

Modifies an existing attribute definition by passing it a new attribute definition. The optional second argument enables you to set a single property. The following property is now supported:

String property	Sets
uri	The URI of an attribute definition.

### Example

```
AttrDef ad = create object type "Integer" attribute "cost"
ad = modify(ad, object type "Integer" attribute "Costing")
ad = modify(ad, setHistory, true)
ad = modify(ad, setDefault, "123")
ad = modify(ad, setURI, "http://www.webaddress.com")
```

---

## Attribute types

---

### setURI

---

#### Declaration

```
AttrType setURI(AttrType at, string URI, string &errMess)
```



```
AttrType setURI(AttrType at, string name, string URI, string &errMsg)
AttrType setURI(AttrType at, int index, string URI, string &errMsg)
```

### Operation

Sets the URI for the specified attribute type. Returns a modified attribute type. If there is an error, the message is returned in the final string parameter. The URI can be set for a specified enumeration value or enumeration index.

### Example

```
AttrType at
string errorMsg
string index[] = { "first", "second", "third" }
at = setURI(at, "http://www.webaddress.com", errorMsg)
at = setURI(at, index[0], "http://www.webaddress.com", errorMsg)
```

## getURI

### Declaration

```
string uri(AttrType at)
string uri(AttrType at, string name)
string uri(AttrType at, int index)
```

### Operation

Gets the URI for the specified attribute type or for a named enumeration value or for a enumeration index.

## Rich text strings

### applyTextFormattingToParagraph

### Declaration

```
string applyTextFormattingToParagraph(string s, bool addBullets,
int indentLevel, int paraNumber, [int firstIndent])
```

### Operation

Applies bullet and/or indent style to the given text, overwriting any existing bullets/indents.

- If *addBullets* is true, adds bullet style.
- If *indentLevel* is nonzero, adds indenting to the value of *indentLevel*. The units for *indentLevel* are twips = twentieths of a point.

- If *paraNumber* is zero, the formatting is applied to all the text. Otherwise it is only applied to the specified paragraph number.
- If the optional parameter *firstIndent* is specified, then this sets the first line indent. If the value is negative then this sets a hanging indent. The units are in points.

The input string *s* must be rich text. For example, from `string s = richText o."Object Text"`.

Returns a rich text string which describes the text with the formatting applied.

## Example

```
Object o = current
string s = o."Object text"
o."Object text" = richText (applyTextFormattingToParagraph(richText
s,true,0,0))
```

Adds bullet style to all of the current object's text.

## Chapter 6

# New in DXL for Rational DOORS 9.3

This chapter describes features that are new in Rational DOORS 9.3:

- Converting a symbol character to Unicode
- Dialog box functions
- Operations on type string
- Embedded OLE objects and the OLE clipboard
- OLE information functions
- Discussions
- RIF ID
- Rational DOORS URLs
- Filters
- Compound Filters
- Localizing DXL
- Finding links
- Links

---

## Converting a symbol character to Unicode

---

### symbolToUnicode

---

#### Declaration

```
char symbolToUnicode(char symbolChar, bool convertAllSymbols)
```

#### Operation

Converts a symbol character to its Unicode equivalent. If *convertAllSymbols* is false, only symbols with the Times New Roman font equivalents are converted.

---

## Dialog box functions

---

### addAcceleratorKey

---

#### Declaration

```
void addAcceleratorKey(DB db, void dxlCallback(), char accelerator, int
modifierKeyFlags)
```

#### Operation

Adds an accelerator key `accelerator` to the dialog `db` with the callback function `dxlCallback()` and the passed-in `modifierKeyFlags`. `modifierKeyFlags` is used in conjunction with the `accelerator` parameter to change which key should be pressed with the accelerator key. Possible values for it are `modKeyNone`, `modKeyCtrl`, `modKeyShift` and `null`.

The specified DXL callback fn `dxlCallback()` executes for the specified keystroke combination being pressed when the DXL dialog box `db` is active.

Only call this perm after the dialog box `db` has been realized, otherwise a DXL run-time error will occur.

#### Example

```
void fn()
{
    print "callback fires\n"
}
DB db = create("testDialog", styleStandard)
realize db

// The callback fn() will be executed on pressing Shift+F7 when the dialog db is
active.
addAcceleratorKey(db, fn, keyF7, modKeyShift)
```

---

## Operations on type string

---

### unicodeString

---

#### Declaration

```
string unicodeString(RTF_string__ str, bool convertAllSymbols, bool
returnAsPlainText)
```

## Operation

Returns the value of the specified rich text string as RTF or plain text. If the attribute contains characters in Symbol font, these characters are converted to the Unicode equivalents.

If *convertAllSymbols* is true, all symbol character are converted. If false, only Unicode characters that have a good chance of being displayed are used. See the *symbolToUnicode* perm for a description of which characters are converted.

The value is returned as plain text if *returnAsPlainText* is true. Otherwise the value is returned as RTF.

## escape

### Declaration

```
string escape(string str, char escapeChar, string escapeChars)
```

### Operation

Escapes all the characters in *str* which are in *escapeChars*, with the *escapeChar* character. This also escapes *escapeChar* itself.

### Example

```
escape("hello world", '/', "l") returns "he/l/lo wor/ld"
```

```
escape("hello world #1", '#', "lh") returns "#he#l#lo wor#ld ##1"
```

## stripPath

### Declaration

```
string stripPath(string path, bool isEscaped)
```

### Operation

Removes the path part from path, using forward slash as the path separator.

If *isEscaped* is true, the slash character can be used as a literal character rather than a path separator by preceding the character with a backslash.

### Example

```
stripPath("abc/def/ghi", b) returns "ghi", where b is true or false.
```

```
stripPath("abc/def\\/ghi", true) returns "def/ghi"
```

---

## Embedded OLE objects and the OLE clipboard

---

### olePasteSpecial

---

#### Declaration

```
string olePasteSpecial(string attrRef, bool displayAsIcon)
```

#### Operation

Copies an OLE object from the clipboard and appends it to *attrRef*. The boolean *displayAsIcon*, when set to `true` will display the OLE object as an icon in the object. Returns null on success and displays an error message on failure.

#### Example

```
Object o = current  
olePasteSpecial(o."object text", false)
```

---

## OLE information functions

---

### oleSetHeightandWidth

---

#### Declaration

```
oleSetHeightandWidth(string attrRef, int height, int width, int index)
```

#### Operation

Sets the height and width of the OLE object within *attrRef* at the specified index.

#### Example

```
Object o = current Object  
oleSetHeightandWidth(o."Object Text", 150, 150, 1)
```

---

# Discussions

---

---

## isDiscussionColumn

---

### Declaration

```
bool isDiscussionColumn(Column c)
```

### Operation

Returns true if the column is a discussion column, otherwise false.

---

## setDiscussionColumn

---

### Declaration

```
void setDiscussionColumn(Column c, string s)
```

### Operation

Sets the filter on the discussion column based on the supplied discussion DXL filename.

### Example

```
Column c
for c in current Module do
{
    if (isDiscussionColumn(c))
    {
        string s = dxlFilename(c)
        if (s != null)
        {
            Module m = edit("/TestDiscussions ", true)
//Open a module, with some discussions in it.
            if (m != null)
            {
                Column cNew = insert(column 3)
                title(cNew, "My copy Discussion")
                string home = getenv("HOME")
                string fullPath = home "\\\" s \"
                string contents = readFile(fullPath)
```

```
//Call dxl PERM on that column before setting the discussion column. The
//discussion column is also a modified version of LAYOUT dxl.
        dxl(cNew, contents)
        setDiscussionColumn(cNew, s)
        width(cNew, 100)
        refresh(m, false)
    }
}
}
```

---

## canModifyDiscussions

---

### Declaration

```
bool canModifyDiscussions({Module m| Item i| string s}[, {User |string}])
```

### Operation

Returns true if a given user or named user (current user if the parameter is not supplied) is allowed to create a discussion or a comment on a discussion for the given module, item or named module. The use of item is intended for use when the Item represents a module.

---

## canEveryoneModifyDiscussions

---

### Declaration

```
bool canEveryoneModifyDiscussions({Module m| Item i})
```

### Operation

Returns true if the discussions access list for the given module or item contains the special "Everyone" group.

---

## addUser

---

### Declaration

```
void addUser(Item i, {User u| string s})
```

### Operation

Adds the user or named user to the Discussion Access List for an Item. The updated list is not saved in the database until `saveDiscussionAccessList` is called.



---

## addGroup

---

### Declaration

```
void addGroup(Item i, {Group g| string s})
```

### Operation

Adds the group or named group to the Discussion Access List for an Item. The updated list is not saved in the database until `saveDiscussionAccessList` is called.

---

## removeUser

---

### Declaration

```
void RemoveUser(Item i, {User u| string s})
```

### Operation

Remove the user or named user from the Discussion Access List for an Item. The updated list is not saved in the database until `saveDiscussionAccessList` is called.

---

## removeGroup

---

### Declaration

```
void removeGroup(Item i, {Group g| string s})
```

### Operation

Remove the group or named group from the Discussion Access List for an Item. The updated list is not saved in the database until `saveDiscussionAccessList` is called.

---

## saveDiscussionAccessList

---

### Declaration

```
string saveDiscussionAccessList(Item i)
```

### Operation

This perm saves the discussion access list for the given item to the database. This perm is only successful for an administrator or a user with manage database privileges. If the call is successful, a null value will be returned, otherwise a string with an error message will be returned.

---

## RIF ID

---

### getRifID

---

#### Declaration

```
string getRifID(Object o)
```

#### Operation

Returns a string with the RIF ID for object *o*. If the object does not have a RIF ID, an empty string is returned.

---

### getObjectByRifID

---

#### Declaration

```
Object getObjectByRifID(Module m, string s)
```

#### Operation

Returns the object within module *m* with a RIF ID of *s*. If the module does not contain an object with the input RIF ID, null is returned.

---

---

## Rational DOORS URLs

---

### getResourceURL

---

#### Declaration

```
string getResourceURL(Module|Object|Database__|ModuleVersion|ModName__|Folder|Project|Item)
```

#### Operation

Returns the resource URL of the passed in item.

---

### getResourceURLConfigOptions

---

#### Declaration

```
void getResourceURLConfigOptions(string &dwaProtocol, string &dwaHost, int &dwaPort)
```

---

## Operation

Gets the *dwaProtocol*, *dwaHost*, and *dwaPort* DBAdmin options configured for this database. The *dwaProtocol*, *dwaHost*, and *dwaPort* parameters contain the values upon return.

## decodeResourceURL

### Declaration

```
string decodeResourceURL(string resourceURL, string &protocol, string& dbHost, int& dbPort, string& repositoryId,
string& dbName, string& dbId, Item&, ModuleVersion&, string& viewName, int& objectAbsno)
```

### Operation

Breaks down a passed-in resource URL into its constituent parts and passes back the information as may be applicable into the reference parameters.

Returns `null` on success, error message on failure.

## Filters

### getSimpleFilterType\_

#### Declaration

```
int getSimpleFilterType_(Filter)
```

#### Operation

Returns the type of the simple filter; attribute, link, object, or column. Please note that the returned value corresponds to the index of the appropriate tab page on the filter dialog. If the specified filter is not a simple filter, -1 is returned.

### getAttributeFilterSettings\_

#### Declaration

```
bool getAttributeFilterSettings_(Module,
                                Filter,
                                string& attributeName,
                                int& comparisonType,
                                string& comparisonValue,
                                bool& matchCase,
                                bool& useRegexp)
```

## Operation

Gets details of the specified attribute filter in the return parameters. The function returns `false` if the filter is not a valid attribute filter.

The `comparisonType` parameter returns the internal index of the comparison. This is different to the index that is used in the associated combo box on the filter dialog. The translation is performed by the DXL code.

## getLinkFilterSettings\_

### Declaration

```
bool getLinkFilterSettings_(Module,
                           Filter,
                           bool& mustHave,
                           int& linkType,
                           string& linkModuleName)
```

### Operation

Gets details of the specified link filter in the return parameters. The function returns `false` if the filter is not a valid link filter.

The `linkType` parameter returns a value that maps directly to the appropriate combo box.

The `linkModuleName` parameter returns an asterisk if links are allowed through any module, or the module name.

## getObjectFilterSettings\_

### Declaration

```
bool getObjectFilterSettings_(Module,
                              Filter,
                              int& objectFilterType)
```

### Operation

Gets details of the specified object filter in the return parameter. The function returns `false` if the filter is not a valid object filter.

The `objectFilterType` parameter returns a value that maps directly to the radio group on the dialog.

## getColumnFilterSettings\_

### Declaration

```
bool getColumnFilterSettings_(Module,
                              Filter,
```

```

string& columnName,
string& comparisonValue,
bool& matchCase,
bool& useRegExp)

```

### Operation

Gets details of the specified column filter in the return parameters. The function returns `false` if the filter is not a valid column filter.

## Compound Filters

These perms can be used to decompose compound filters into their component parts for analysis, and potential modification or replacement.

See examples in “Compound filters” on page 654.

### getCompoundFilterType\_

#### Declaration

```
int getCompoundFilterType_(Filter)
```

#### Operation

Returns an integer value indicating the type of the specified filter.

It returns one of the following new DXL constant values for compound filter types:

```
int filterTypeAnd
```

```
int filterTypeOr
```

```
int filterTypeNot
```

It returns `-1` for a simple filter. The test for a negative value suffices to indicate that the filter is not compound, as the new constants are all positive values.

If no filter is supplied, a run-time DXL error is generated.

### GetComponentFilter\_

#### Declaration

```
Filter GetComponentFilter_(Filter, int index)
```

#### Operation

Returns an integer value indicating the type of the specified filter.

It returns one of the following new DXL constant values for compound filter types:

```
int filterTypeAnd
```

```
int filterTypeOr
```

```
int filterTypeNot
```

This perm returns a component filter that is part of the supplied compound filter. If the compound filter is of type *filterTypeNot*, the index must be zero, or the perm returns null. If the compound filter is of type *filterTypeOr* or *filterTypeAnd*, an index of 0 or 1 returns the first or second sub-filter, and any other index value returns null.

If the supplied filter is not a compound filter, the perm returns null.

If no filter is supplied, a run-time DXL error is generated.

## Localizing DXL

Rational DOORS uses ICU resource bundles for accessing translated strings. DXL perms are available to access ICU resource bundles containing translated strings for customized DXL. For information about creating ICU resource bundles, see <http://userguide.icu-project.org/locale/localizing>.

Put the language resource files in a directory whose name is taken as the *bundle name*, under *\$DOORSHOME/language*, for example *\$DOORSHOME/language/myResource/de\_DE.res*. There are two bundles already shipped with Rational DOORS, *core* and *DXL*.)

## LS\_

### Declaration

```
string LS_(string key, string fallback, string bundle)
```

### Operation

Returns the string from resource bundle that is identified by key. If the string identified by key is not found in the resource bundle, the fallback string is returned.

### Example

de.txt file contains;

```
de {
    Key1{"Ausgehend"}
    Key2{"Ausgehende Links"}
    Key3{"Normalansicht"}
    Key4{"Klartext"}
}
```

From the command line, generate a resource bundle, for example `genrb de.txt`, and copy the resource bundle to `$DOORSHOME/language/myResource/`, where *myResource* is the name of your resource bundle. The localized strings can then be accessed using the `LS_` perm, for example in the DXL editor, type:

```
print LS_("Key1", "Ausgehend not found", "myResource") "\n"
print LS_("Key2", "Ausgehende Links not found", "myResource") "\n"
print LS_("Key3", "Normalansicht not found", "myResource") "\n"
print LS_("Key4", "Klartext not found", "myResource") "\n"
```

The output is:

```
Ausgehend
Ausgehende Links
Normalansicht
Klartext
```

---

## Finding links

---

### for each incoming link

---

#### Syntax

```
for LinkRef in each(Object tgtObject) <- (string
  linkModuleName) do {
  ...
}
```

where:

<i>LinkRef</i>	is a variable of type <code>Link</code> or <code>LinkRef</code>
<i>tgtObject</i>	is a variable of type <code>Object</code>
<i>linkModuleName</i>	is a string variable

#### Operation

Assigns the variable *LinkRef* to be each successive incoming link arriving at object *tgtObject* via link module named *linkModuleName*. The string *linkModuleName* can be a specific link module name, or the string "\*" meaning any link module.

Iterates through all incoming link references including those from baselines and soft-deleted modules.

**Note:** This loop only assigns to *LinkRef* incoming link values for which the source object is loaded; unloaded links are not detected.

## Example

```
LinkRef l
for l in each(current Object) <- "*" do {
    string user = l."Created By"
    print user "\n"
}
```

---

## for each source

---

### Syntax

```
for srcModName in each(Object tgtObject) <- (string
    linkModName) do {
    ...
}
```

where:

<i>srcModName</i>	is a string variable
<i>tgtObject</i>	is a variable of type Object
<i>linkModName</i>	is a string variable

### Operation

Assigns the variable *srcModName* to be the unqualified name of the source module of each successive incoming link arriving at object *tgtObject* via link module named *linkModuleName*. The string *linkModuleName* can be a specific link module name, or the string "\*" meaning any link module.

Includes links from baselines and soft-deleted modules, returning the name of the source module (without baseline version numbers).

**Note:** This loop assigns to *modName* values for all incoming links, whether the source is loaded or not. This can be used to pre-load all incoming link sources before using the `for all incoming links` loop.

### Example

This example prints the unqualified name of all the source modules for incoming links to the current object:

```
Object o = current
string srcModName
for srcModName in each o<-"*" do print srcModName "\n"
```



---

## for each source reference

---

### Syntax

```
for srcModRef in each(Object tgtObject) <- (string
    linkModName) do {
    ...
}
```

where:

<i>srcModRef</i>	is a variable of type ModName_
<i>tgtObject</i>	is a variable of type Object
<i>linkModName</i>	is a string variable

### Operation

Assigns the variable *srcModRef* to be the reference of the source module of each successive incoming link arriving at object *tgtObject* via link module named *linkModuleName*. The string *linkModuleName* can be a specific link module name, or the string "\*" meaning any link module.

Includes links from baselines and soft-deleted modules.

**Note:** This loop assigns to *modName* values for all incoming links, whether the source is loaded or not. This can be used to pre-load all incoming link sources before using the `for all incoming links` loop.

### Example

```
ModName_ srcModRef
for srcModRef in each o<-"*" do
    read(fullName(srcModRef), false)
```

---

## Links

---

### getlegacyURL

---

#### Declaration

```
string getLegacyURL(object o)
```

#### Operation

This perm returns the legacy Rational DOORS URL. The legacy URL contains the protocol as "doors". This URL can then be decoded using `decodeURL`.

## Example

```

ModuleVersion mv
int objectAbsno
Item i
string dbHost = null
int dbPort
string dbName
string dbID = null

string objUrl = getURL(current Object)

string legacyUrl
string errorMsg
errorMsg = getLegacyURL(objUrl, legacyUrl)
if(!null errorMsg)
{
    print errorMsg "\n"
}
else
{
    errorMsg = decodeURL(legacyUrl, dbHost, dbPort, dbName, dbID, i, mv,
objectAbsno)
}
if(!null errorMsg)
{
    print errorMsg "\n"
}
else
{
    print "Original URL - " objUrl "\nDB Host - " dbHost "\n"
    print "DB Port - " dbPort "\nDB Name - " dbName "\nDB Id - " dbId
"\nAbsolute Number - " objectAbsno "\n"
}

```

## Chapter 7

# New in DXL for Rational DOORS 9.2

This chapter describes features that are new in Rational DOORS 9.2:

- Additional authentication
- Dialog box updates
- New constants
- Partitions updates
- Requirements Interchange Format (RIF)

---

## Additional authentication

---



---

### getAdditionalAuthenticationEnabled

---

#### Declaration

```
bool getAdditionalAuthenticationEnabled()
```

#### Operation

Returns `true` if enhanced security users need to perform additional authentication during login. Only relevant when authentication is being controlled via RDS.

---

### getAdditionalAuthenticationPrompt

---

#### Declaration

```
string getAdditionalAuthenticationPrompt()
```

#### Operation

Returns the label under which additional authentication is requested, if enhanced security is enabled, for example the label for the second “password” field. Only relevant when authentication is being controlled via RDS.

---

### getSystemLoginConformityRequired

---

#### Declaration

```
bool getSystemLoginConformityRequired()
```

## Operation

Returns `true` if enhanced security users have their system login verified when logging in. Only relevant when authentication is being controlled via RDS.

---

## getCommandLinePasswordDisabled

---

### Declaration

```
bool getCommandLinePasswordDisabled()
```

### Operation

Return `true` if the `-P` command line password argument is disabled by default.

---

## setCommandLinePasswordDisabled

---

### Declaration

```
string setCommandLinePasswordDisabled(bool)
```

### Operation

Sets whether the `-P` command line password argument is disabled by default. Supplying `true` disables the option by default.

---

## Dialog box updates

---



---

## toolBarComboGetEditBoxSelection

---

### Declaration

```
string toolBarComboGetEditBoxSelection(DBE toolbar, int index)
```

### Operation

Returns the selected text from the editable combo box in *toolbar* where *index* is the combo box index.

---

## toolBarComboCutCopySelectedText

---

### Declaration

```
void toolBarComboCutCopySelectedText(DBE toolbar, int index, bool cut)
```

## Operation

Cuts, or copies, the selected text in the editable combo box in *toolbar* at location *index*. If *cut* is *true*, the selected text is cut to the clipboard. Otherwise, it is copied.

## toolBarComboPasteText

### Declaration

```
void toolBarComboPasteText(DBE toolbar, int index)
```

### Operation

Pastes text from the clipboard into the combo box located at *index* in *toolbar*. Replaces selected text if there is any.

## hasFocus

### Declaration

```
bool hasFocus(DBE toolbar)
```

### Operation

Returns *true* if the supplied *toolbar* DBE contains an element that currently has the keyboard focus. Otherwise, returns *false*.

## setDXLWindowAsParent

### Declaration

```
void setDXLWindowAsParent(DB dialog)
```

### Operation

Sets the DXL interaction window to be the parent of *dialog*. If there is no DXL interaction window, the parent is set to *null*.

## New constants

### mayUseCommandLinePassword

#### Declaration

```
bool mayUseCommandLinePassword
```

## Operation

Boolean property of a *User*. When command line passwords are disabled by default, this returns *true* if they have been enabled for the given *User*. Otherwise, returns *false*.

## additionalAuthenticationRequired

### Declaration

```
bool additionalAuthenticationRequired
```

### Operation

Boolean property of a *User*. Returns true if the *User* needs to perform additional authentication during login. Only relevant when authentication is performed via RDS.

## iconAuthenticatingUser

### Declaration

```
Icon iconAuthenticatingUser
```

### Operation

The icon used to represent a user required to perform additional authentication during login.

## Partitions updates

### addAwayModule

#### Declaration

```
string addAwayModule(PartitionDefinition pd, string modName[, string partName])
```

#### Operation

Used to add a formal module to a partition in the away database.

The new, optional parameter can be used to specify the partition name where it may vary from the definition name.

### addAwayLinkModule

#### Declaration

```
string addAwayLinkModule(PartitionDefinition pd, string modName[, string partName])
```

## Operation

Used to add a link module to a partition in the away database.

The new, optional parameter can be used to specify the partition name where it may vary from the definition name.

---

# Requirements Interchange Format (RIF)

---



---

## exportType

---

### Declaration

```
void initRIFExport(ExportType)
```

### Operation

Sets the export type to be either RIF or ReqIF. Call this before using the `exportPackage` method.

### example

```
initRIFExport(exportRIF_1_2) // Sets the export to be RIF
initRIFExport(exportReqIF) // Sets the export to be ReqIF
```

---

## exportPackage

---

### Declaration

```
string exportPackage(RifDefinition def, Stream RifFile, DB parent, bool& cancel)
```

### Operation

Exports *def* to the XML file identified by *RifFile*. The stream must be have been opened for writing using “*write (filename, CP\_UTF8)*”. If *parent* is null then a non-interactive operation is performed. Otherwise, progress bars will be displayed.

If an interactive export is performed, and is cancelled by the user, *cancel* will be set to *true*.

---

## importRifFile

---

### Declaration

```
string importRifFile(string RifFilename, Folder parent, string targetName,
string targetDesc, string RifDefName, string RifDefDescription, DB parent)
```

### Operation

Performs a non-interactive import of *RifFileName*, placing the imported modules in a new folder in the specified *parent*. The new folder name and description are specified by *targetName* and *targetDesc*.

---

## rifMerge

---

### Declaration

```
string rifMerge(RifImport mrgObj, DB parent)
```

### Operation

Performs a non-interactive merge using the information in *mrgObj*.

---

## RifDefinition

---

A `RifDefinition` is the object in which a package to be exported in RIF format is defined.

Properties are defined for use with the `.` (dot) operator and a `RifDefinition` handle to extract information from a definition, as shown in the following syntax:

```
variable.property
```

where:

*variable* is a variable of type `RifDefinition`.

*property* is one of the following properties.

The following tables list the `RifDefinition` properties and the information they extract or specify

String property	Extracts
<code>name</code>	The name of the definition.
<code>description</code>	The description of the definition.
<code>rifDefinitionIdentifier</code>	The unique ID of the RIF definition (this is shared between databases, unlike the name and description).

boolean property	Extracts
<code>createdLocally</code>	Returns <code>true</code> if the definition was created in the local database, as opposed to being imported.
<code>canModify</code>	Returns <code>true</code> if the correct user can modify the definition.

Project property	Extracts
<code>project</code>	The project which contains the definition.



---

## RifModuleDefinition

---

A `RifModuleDefinition` is an object which contains the details of how a module should be exported, as part of a RIF package.

Properties are defined for use with the `.` (dot) operator and `RifModuleDefinition` handle to extract information from, a definition record, as shown in the following syntax:

```
variable.property
```

where:

*variable* is a variable of type `RifModuleDefinition`.

*property* is one of the properties below.

The following tables list the `RifModuleDefinition` properties and the information they extract or specify:

<b>String property</b>	<b>Extracts</b>
<code>dataConfigView</code>	The name of the view used to define which data in the module will be included in the RIF export.
<code>ddcView</code>	The name of the view used to define what data can be edited when the exported RIF package is imported into another database.
<b>bool property</b>	<b>Extracts</b>
<code>createdLocally</code>	Whether the module was added to the <code>RifDefinition</code> in the current database or not.
<b>ModuleVersion property</b>	<b>Extracts</b>
<code>moduleVersion</code>	The <code>ModuleVersion</code> reference for the given <code>RifModuleDefinition</code> .
<b>Ddcmode property</b>	<b>Extracts</b>
<code>ddcMode</code>	The type of access control used to define whether the module, or its contents, will be editable in each database once it has been exported.

---

## DdcMode constants

---

DdcMode constants define the type of access control used to define whether a module, or its contents, will be editable in each of the local and target database once the export has taken place. The following table details the possible values, and their meanings.

Constant	Meaning
<code>ddcNone</code>	Module will be editable in both source and target databases.
<code>ddcReadOnly</code>	Module will be editable in only the source database.
<code>ddcByObject</code>	Selected objects in the module will be made read-only in the source database.
<code>ddcByAttribute</code>	Selected attributes in the module will be made read-only in the source database.
<code>ddcFullModule</code>	Module will not be editable.

---



---

## RifImport

---

A `RifImport` is an object which contains information on a RIF import. These are created by import operations, and are persisted in a list in the stored `RifDefinition`.

Properties are defined for use with the `.` (dot) operator and a `RifImport` handle to extract information from, or specify information in an import record, as shown in the following syntax:

*variable.property*

where:

*variable* is a variable of type `RifImport`.

*property* is one of the properties.

The following tables list the `RifImport` properties and the information they extract or specify :

bool property	Extracts
<code>mergeStarted</code>	Returns true when a merge operation is started.
<code>mergeCompleted</code>	Returns true when the merge has been completed.
<code>mergeRequired</code>	Returns true when an import is a valid candidate for merging.
<code>mergeDisabled</code>	Returns true if the merge has been disabled due to lock removal.

---

User property	Extracts
<code>importedBy</code>	Returns the user who performed the import.

---

User property	Extracts
<code>mergedBy</code>	Returns the user who preformed the merge.

Folder property	Extracts
<code>folder</code>	Returns the folder containing the imported data. On import, a DXL script is expected to iterate through the contents of this folder, merging all items which have RIF IDs, and which are persisted in this folder.

Date property	Extracts
<code>exportTime</code>	Returns the time the export was performed. Note that this is the timestamp derived from the <code>creationTime</code> element of the header in the imported RIF package. Merges should be performed in the order in which the data was exported, rather than the order in which the packages were imported.
<code>importTime</code>	Returns the date that the import folder was created.
<code>mergeTime</code>	Returns the date that the merge of the import folder was completed, or started if it has not yet been completed.

RifDefinition property	Extracts
<code>definition</code>	Returns the <code>RifDefinition</code> with which the import is associated.

---

## for RifDefinition in Project

---

### Syntax

```
for rifDef in proj do {
...
}
```

### Operation

Assigns `rifDef` to be each successive `RifDefinition` in Project `proj`.

---

## for RifModuleDefinition in RifDefinition

---

### Syntax

```
for rifModDef in rifDef so {
...
}
```

## Operation

Assigns *rifModDef* to be each successive *RifModuleDefinition* in *RifDefinition* *rifDef*.

## for RifImport in RifDefinition

### Syntax

```
for rifImp in rifDef do {
...
}
```

### Operation

Assigns *rifImp* to be each successive *rifImport* in *RifDefinition* *rifDef*.

## Examples

The following example dumps all information about all RIF definitions in the current project to the screen. It then conditional exports one of the packages.

```
RifDefinition rd
RifModuleDefinition rmd
Stream stm = write ("C:\\Public\\rifExport.xml", CP_UTF8)
string s = ""
bool b
Project p = current
Project p2
ModuleVersion mv
DB myDB = null
DdcMode ddcM

for rd in p do {

    print rd.name "\n"
    print rd.description "\n"
    print rd.rifDefinitionIdentifier "\n"

    if (rd.createdLocally) {
```

```
    print "Local DB\n"
}

if (rd.canModify) {

    print "May be modified by current user\n"
}

p2 = rd.project

print fullName p "\n"

for rmd in rd do {

    print "\nModules present in definition :\n"

    mv = rmd.moduleVersion
    print fullName mv "\t"

    print rmd.dataConfigView "\t"
    print rmd.ddcView "\t"

    if (rmd.createdLocally) {

        print "Home DB.\n"
    }

    ddcM = rmd.ddcMode

    if (ddcM == ddcFullModule){

        print "Module will not be editable once definition is exported.\n"

    } else if (ddcM == ddcByObject){
```

```

        print "Selected objects will be locked in the local database once the
definition is exported.\n"

    } else if (ddcm == ddcByAttribute){

        print "Selected attributes will be locked in the local database once
the definition is exported.\n"

    } else if (ddcm == ddcReadOnly){

        print "Module will only be editable in the local database once
definition is exported.\n"

    } else if (ddcm == ddcNone){

        print "Module will be fully editable in both local and target
databases when definition is exported.\n"

    }
}

if (rd.name == "RifDef1"){

    s = exportPackage (rd, stm, myDB, b)

    if (s != ""){

        print "Error occurred : " s "\n"
    }
}
}

```

The following example dumps all information about all RIF imports in the current project. It then merges those imports where required.

```

RifImport ri
RifDefinition rd
Project p = current
User importer, merger
string importerName, mergerName, res
Folder f
Skip dates = create

for rd in p do {

    for ri in rd do {

        rd = ri.definition
        print rd.name "\n"

        f = ri.folder
        print "Located in : " fullName f
        print "\n"

        importer = ri.importedBy
        importerName = importer.name
        print "Imported by : " importerName "\n"

        print "Imported on : " ri.importTime "\n"

        if (ri.mergeStarted && !ri.mergeCompleted) {

            print "Merge started on : " ri.mergeTime "\n"

        } else if (ri.mergeCompleted) {

            print "Merge completed on : " ri.mergeTime "\n"

```

```
    }

    if (ri.mergeRequired) {

        print "Merge required.\n"
        res = rifMerge (ri, null)
        print "Merging result : " res "\n"

    } else {

        merger = ri.mergedBy
        print "Merged by : " mergerName "\n"
    }

    if (ri.mergeDisabled) {

        print "Merge disabled, locks removed.\n"
    }
    print "\n"
}
}
```



## Chapter 8

# New in DXL for Rational DOORS 9.1

This chapter describes features that are new in Rational DOORS 9.1:

- Regular Expressions

---

## Regular Expressions

---

### regexp2

---

#### Declaration

```
Regex regexp2(string expression)
```

#### Operation

Creates a regular expression. Its behavior will not be changed to match the legacy behavior of `regexp()`. Should be used in all new regular expression code.



## Chapter 9

# New in DXL for Rational DOORS 9.0

This chapter describes features that are new in Rational DOORS 9.0:

- Discussions
- Descriptions
- Filtering
- HTML
- Miscellaneous

---

## Discussions

- Discussion Types
- Properties
- Iterators
- Operations
- Triggers
- Example

---

## Discussion Types

---

### Discussion

---

Represents a discussion.

---

### Comment

---

Represents a comment in a discussion.

---

### DiscussionStatus

---

Represents the status of a discussion. The possible values are `Open` and `Closed`.

---

## Properties

The following tables describe the properties available for the discussion and comment types. Property values can be accessed using the . (dot) operator, as shown in the following syntax:

*variable.property*

where:

*variable* is a variable of type `Discussion` or `Comment`

*property* is one of the discussion or comment properties

---

### Discussion

---

Property	Type	Extracts
<code>status</code>	<code>DiscussionStatus</code>	The status of the discussion: whether it is open or closed.
<code>summary</code>	<code>string</code>	The summary text of the discussion, which may be null
<code>createdBy</code>	<code>User</code>	The user who created the discussion, if it was created in the current database. Otherwise it returns null.
<code>createdByName</code>	<code>string</code>	The name of the user who created the discussion, as it was when the discussion was created.
<code>createdByFullName</code>	<code>string</code>	The full name of the user who created the discussion, as it was when the discussion was created.
<code>createdOn</code>	<code>Date</code>	The date and time the discussion was created.
<code>createdDataTimestamp</code>	<code>Date</code>	The last modification timestamp of the object or module that the first comment in the discussion referred to.
<code>lastModifiedBy</code>	<code>User</code>	The user who added the last comment to the discussion, or who last changed the discussion status
<code>lastModifiedByName</code>	<code>string</code>	The user name of the user who added the last comment to the discussion, or who last changed the discussion status.

---

Property	Type	Extracts
<code>lastModifiedByFullName</code>	<code>string</code>	The full name of the user who added the last comment to the discussion, or who last changed the discussion status.
<code>lastModifiedOn</code>	<code>Date</code>	The date and time the last comment was added, or when the discussion status was last changed.
<code>lastModifiedDataTimestamp</code>	<code>Date</code>	The last modification timestamp of the object or module that the last comment in the discussion referred to.
<code>firstVersion</code>	<code>ModuleVersion</code>	<p>The version of the module the first comment was raised against.</p> <p><b>Note:</b> If a comment is made against the current version of a module and the module is then baselined, this property will return a reference to that baseline. If the baseline is deleted, it will return the deleted baseline.</p>
<code>lastVersion</code>	<code>ModuleVersion</code>	The version of the module the latest comment was raised against. See note for the <code>firstVersion</code> property above.
<code>firstVersionIndex</code>	<code>string</code>	The baseline index of the first module version commented on in the discussion. Can be used in comparisons between module versions.
<code>lastVersionIndex</code>	<code>string</code>	The baseline index of the last module version commented on in the discussion. Can be used in comparison between module versions.

---

## Comment

---

Property	Type	Extracts
text	string	The plain text of the comment.
moduleVersionIndex	string	The baseline index of the module version against which the comment was raised. Can be used in comparisons between module versions.
status	DiscussionStatus	The status of the discussion in which the comment was made.
moduleVersion	ModuleVersion	The version of the module against which the comment was raised.  <b>Note:</b> If a comment is made against the current version of a module and the module is then baselined, this property will return a reference to that baseline. If the baseline is deleted, it will return the deleted baseline.
onCurrentVersion	bool	True if the comment was raised against the current version of the module or an object in the current version.
changedStatus	bool	Tells whether the comment changed the status of the discussion when it was submitted. This will be true for comments that closed or re-opened a discussion.
dataTimestamp	Date	The last modified time of the object or module under discussion, as seen at the commenting users client at the time the comment was submitted.
createdBy	User	The user that created the comment. Returns null if the user is not in the current user list.
createdByName	string	The user name of the user who created the comment, as it was when the comment was created.
createdByFullName	string	The full name of the user who created the comment, as it was when the comment was created.
createdOn	Date	The data and time when the comment was created.
discussion	Discussion	The discussion containing the comment.

---

## Iterators

---

## for Discussion in Type

---

### Syntax

```
for disc in Type do {
  ...
}
```

where:

*disc* is a variable of type `Discussion`

*Type* is a variable of type `Object`, `Module`, `Project` or `Folder`

### Operation

Assigns the variable *disc* to be each successive discussion in *Type* in the order they were created. The first time it is run the discussion data will be loaded from the database.

The `Module`, `Folder` and `Project` variants will not include discussions on individual objects.

The `Folder` and `Project` variants are provided for forward compatibility with the possible future inclusion of discussions on folders and projects. They perform no function in Rational DOORS 9.0.

---

## for Comment in Discussion

---

### Syntax

```
for comm in disc do {
  ...
}
```

where:

*comm* is a variable of type `Comment`

*disc* is a variable of type `Discussion`

### Operation

Assigns the variable *comm* to be each successive comment in *disc* in chronological order. The first time it is run on a discussion in memory, the comments will be loaded from the database. Note that if a discussion has been changed by a refresh (e.g. in terms of the last `Comment` timestamp) then this will also refresh the comments list.

The discussion properties will be updated in memory if necessary, to be consistent with the updated list of comments.

---

## Operations

---

---

### create(Discussion)

---

#### Declaration

```
string create(target, string text, string summary, Discussion& disc)
```

#### Operation

Creates a new `Discussion` about `target`, which can be of type `Object` or `Module`. Returns null on success, error string on failure. Also add `text` as the first comment to the discussion.

---

---

### addComment

---

#### Declaration

```
string addComment(Discussion disc, target, string text, Comment& comm)
```

#### Operation

Adds a `Comment` about `target` to an open `Discussion`. Note that `target` must be an `Object` or `Module` that the `Discussion` already relates to. Returns null on success, error string on failure.

---

---

### closeDiscussion

---

#### Declaration

```
string closeDiscussion(Discussion disc, target, string text, Comment& comm)
```

#### Operation

Closes an open `Discussion` `disc` by appending a closing comment, specified in `text`. Note that `target` must be an `Object` or `Module` that `disc` already relates to. Returns null on success, error string on failure.

---

---

### reopenDiscussion

---

#### Declaration

```
string reopenDiscussion(Discussion disc, target, string text, Comment& comm)
```

#### Operation

Reopens a closed `Discussion` `disc` and appends a new comment, specified in `text`. Note that `target` must be an `Object` or `Module` that `disc` already relates to. Returns null on success, error string on failure.



---

## deleteDiscussion

---

### Declaration

```
string deleteDiscussion(Discussion d, Module m|Object o)
```

### Operation

Deletes the specified module or object discussion if the user has the permission to do so. Returns null on success, or an error string on failure.

---

## sortDiscussions

---

### Declaration

```
void sortDiscussions({Module m|Object o|Project p|Folder f}, property, bool ascending)
```

### Operation

Sorts the discussions list associated with the specified item according to the given *property*, which may be a date, or a string property as listed in the discussions properties list. String sorting is performed according to the lexical ordering for the current user's default locale at the time of execution.

If the discussion list for the specified item has not been loaded from the database, this perm will cause it to be loaded.

The `Folder` and `Project` forms are provided for forward compatibility with the possible future inclusion of discussions on folders and projects. They perform no function in 9.0.

---

## getDiscussions

---

### Declaration

```
string getDiscussions({Module m|Object o|Project p|Folder f})
```

### Operation

Refreshes from the database the `Discussion` data for the specified item in memory. Returns null on success, or an error on failure.

---

## getObjectDiscussions

---

### Declaration

```
string getObjectDiscussions(Module m)
```

### Operation

Refreshes from the database all `Discussions` for all objects in the specified module. Returns null on success, or an error on failure

---

## getComments

---

### Declaration

```
string getComments(Discussion d)
```

### Operation

Refreshes from the database the comments data for the specified `Discussion` in memory. Returns null on success, or an error on failure.

**Note:** The `Discussion` properties will be updated if necessary, to be consistent with the updated comments list.

---

## mayModifyDiscussionStatus

---

### Declaration

```
bool mayModifyDiscussionStatus(Discussion d, Module m)
```

### Operation

Checks whether the current user has rights to close or re-open the specified discussion on the specified module.

---

## baselineIndex

---

### Declaration

```
string baselineIndex(Module m)
```

### Operation

Returns the baseline index of the specified `Module`, which may be a baseline or a current version. Can be used to tell whether a `Comment` can be raised against the given `Module` data in a given `Discussion`.

**Note:** A `Comment` cannot be raised against a baseline index which is less than the `lastVersionIndex` property of the `Discussion`.

---

## Triggers

Trigger capabilities have been expanded so that triggers can now be made to fire before or after a `Discussion` or a `Comment` is created.

As follows:

	pre	post
Comment	x	x

	pre	post
Discussion	x	x

---

## comment

---

### Declaration

```
Comment comment(Trigger t)
```

### Operation

Returns the `Comment` with which the supplied `Trigger` is associated, null if not a `Comment` trigger.

---

## discussion

---

### Declaration

```
Discussion discussion(Trigger t)
```

### Operation

Returns the `Discussion` with which the supplied `Trigger` is associated, null if not a `Discussion` trigger.

---

## dispose(Discussion/Comment)

---

### Declaration

```
void dispose({Discussion& d|Comment& c})
```

### Operation

Disposes of the supplied `Comment` or `Discussion` reference freeing the memory it uses.

Can be called as soon as the reference is no longer required.

**Note:** The disposing will take place at the end of the current context.

---

## Example

```
// Create a Discussion on the current Module, with one follow-up Comment...
Module m = current
Discussion disc = null
create(m, "This is my\nfirst comment.", "First summary", disc)
Comment cmt
```

```

addComment(disc, m, "This is the\nsecond comment.", cmt)

// Display all Discussions on the Module
for disc in m do
{
    print disc.summary " (" disc.status ") \n"
    User u = disc.createdBy
    string s = u.name
    print "Created By: " s "\n"
    print "Created By Name: \"" disc.createdByName "\" \n"
    print "Created On: " stringOf(disc.createdOn) "\n"
    u = disc.lastModifiedBy
    s = u.name
    print "Last Mod By: " s "\n"
    print "Last Mod By Name: \"" disc.lastModifiedByName "\" \n"
    print "Last Mod On " stringOf(disc.lastModifiedOn) "\n"
    print "First version: " (fullName disc.firstVersion) " [" //-(
        (versionString disc.firstVersion) "]\n"
    print "Last version: " (fullName disc.lastVersion) " ["
        (versionString disc.lastVersion) "]\n"
    Comment c
    for c in disc do
    {
        print "Comment added by " (c.createdByName) " at " //-(
            (stringOf(c.createdOn)) ":\n"
        print "Module Version: " (fullName c.moduleVersion) " [" //-(
            (versionString c.moduleVersion) "]\n"
        print "Data timestamp: " (stringOf c.dataTimestamp) "\n"
        print "Status: " c.status " (" (c.changedStatus ? "Changed" //-
            : "Unchanged") ")\n"
        print "On current: " c.onCurrentVersion "\n"
        print c.text "\n"
    }
}
}

```

---

## Descriptions

This section describes the DXL support in Rational DOORS for the new description functionality.

- View Descriptions
- Attribute Type Descriptions
- Attribute Definition Descriptionss

---

## View Descriptions

---

### setViewDescription

---

#### Declaration

```
void setViewDescription(ViewDef vd, string desc)
```

#### Operation

Sets the description for a view where *vd* is the view definition handle.

---

### getViewDescription

---

#### Declaration

```
string getViewDescription(ViewDef vd)
```

#### Operation

Returns the description for a view where *vd* is the view definition handle.

---

## Attribute Type Descriptions

---

### setDescription

---

#### Declaration

```
AttrType setDescription(AttrType at, string desc, string &errMsg)
```

#### Operation

Sets the description for the specified attribute type. Returns null if the description is not successfully updated.

---

## modify

---

### Declaration

```
AttrType modify(AttrType at, string name, string codes[], int values, int
colors, string desc[], [int arrMaps[],] string &errMess)
```

### Operation

Modifies the supplied attribute type with the corresponding values and descriptions. Can be used to update the descriptions of old enumeration types.

The optional *arrMaps* argument specifies existing index values for enumeration values, taking into consideration their re-ordering.

---

## create

---

### Declaration

```
AttrType create(string name, string codes[], int values[], int colors[], string
descs[], string &errMess)
```

### Operation

The new *descs[]* argument enables the creation of a new enumeration based attribute type, whose enumerations use those descriptions. Returns null if creation is not successful.

---

## description property

---

Both attribute types themselves, and the enumeration values they may contain, have a new *description* property. It can be accessed by using the dot (.) operator.

### Example

```
AttrType at
string desc
int i
...
//To get the description of the attribute type
desc = at.description
...
//To get the description of the enumeration values with index i

desc = at.description[i]
```

---

## Attribute Definition Descriptions

---

### description property

---

Attribute definitions can now contain a `description` property. It can be accessed by using the dot (`.`) operator.

#### Example

```
Module m = current
AttrDef ad = find(m, "AttrName")
print ad.description
```

---

### description(create)

---

Attribute definition descriptions can be specified during their creation.

#### Example

```
AttrDef ad = create object (description "My description") (type "string") //-
    (default "defvalue") (attribute "AttrName")
```

---

### description(modify)

---

Attribute definition descriptions can be altered by using the `modify` perm is one of the following ways. Note the new `setDescription` property constant.

#### Example1

```
Module m = current
AttrDef ad = find(m, "AttrName")
modify (ad, module (description "New Description") (type "string") //-
    (default "New default") (attribute "New Name"))
```

#### Example2

```
Module m = current
AttrDef ad = find(m, "AttrName")
modify (ad, setDescription, "New description text")
```

---

## Filtering

This section describes the DXL support in Rational DOORS for the new module explorer filtering functionality added in Rational DOORS 9.0.

---

### applyFiltering

---

#### Declaration

```
void applyFiltering (Module)
```

#### Operation

Sets the module explorer display to reflect the current filter applied to the specified module.

---

### unApplyFiltering

---

#### Declaration

```
void unApplyFiltering (Module)
```

#### Operation

Switches off filtering in the module explorer for the specified module.

---

### applyingFiltering

---

#### Declaration

```
bool applyingFiltering (Module)
```

#### Operation

Returns a boolean indicating whether filtering is turned on in the module explorer for the specified module.

---

## HTML

This section describes the DXL support the HTML functionality added in Rational DOORS 9.0.

- HTML Control
- HTML Edit Control



---

## HTML Control

The section describes the DXL support for the HTML control added in Rational DOORS 9.0.

**Note:** Some of the functions listed below take an ID string parameter to identify either a frame or an HTML element. In each of these methods, frames or elements nested within other frames are identified by concatenating the frame IDs and element IDs as follows: `<top frame ID>/[<sub frame ID>/...]<element ID>`.

In methods requiring a frame ID, passing `null` into this parameter denotes the top level document.

These methods refer to all frame types including IFRAME and FRAME elements.

---

### htmlView

---

#### Declaration

```
DBE htmlView(DB parentDB, int width, int height, string URL, bool
before_navigate_cb(DBE element, string URL, string frame, string postData), void
document_complete_cb(DBE element, string URL), bool navigate_error_cb(DBE
element, string URL, string frame, int statusCode), void progress_cb(DBE
element, int percentage))
```

#### Operation

Creates an HTML view control where the arguments are defined as follows:

<b>parentDB</b>	<b>The dialog box containing the control.</b>
<code>width</code>	The initial width of the control.
<code>height</code>	The initial height of the control.
<code>URL</code>	The address that will be initially loaded into the control. Can be null to load a blank page (about:blank).

**parentDB**`before_navigate_cb`**The dialog box containing the control.**

Fires for each document/frame before the HTML window/frame navigates to a specified URL. It could be used, amongst other things, to intercept and process the URL prior to navigation, taking some action and possibly also navigating to a new URL.

The return value determines whether to cancel the navigation. Returning `false` cancels the navigation.

Its arguments are defined as follows:

- `element`: The HTML control itself
- `URL`: The address about to be navigated to.
- `frame`: The frame for which the navigation is about to take place.
- `postData`: The data about to be sent to the server if the HTTP POST transaction is being used.

`document_complete_cb`

Fires for each document/frame once they are completely loaded and initialized. It could be used to start functionality required after all the data has been received and is about to be rendered, for example, parsing the HTML document.

Its arguments are defined as follows:

- `element`: The HTML control itself
- `URL`: The loaded address.

`navigate_error_cb`

Fires when an error occurs during navigation. Could be used, for example, to display a default document when internet connectivity is not available.

The return value determines whether to cancel the navigation. Returning `false` cancels the navigation.

Its arguments are defined as follows:

- `elements`: The HTML control itself.
- `URL`: The address for which navigation failed.
- `frame`: The frame for which the navigation failed.
- `statusCode`: Standard HTML error code.

`progress_cb`

Used to notify about the navigation progress, which is supplied as a percentage.

---

## set(html callback)

---

### Declaration

```
void set(DBE HTMLView, bool event_cb(DBE element, string ID, string tag, string event_type))
```

### Operation

Attaches a callback to HTML control element that receives general HTML events. The *ID* argument identifies the element that sourced the event, the *tag* argument identifies the type of element that sourced the event, and the *event\_type* argument identifies the event type. Note that the only event types currently supported are `click` and `dblclick`.

If this function is used with an incorrect DBE type, a DXL runtime error occurs.

---

## set(html URL)

---

### Declaration

```
void set(DBE HTMLView, string URL)
```

### Operation

Navigates the given *HTMLView* to the given *URL*.

Can only be used to navigate the top level document and cannot be used to navigate nested frame elements.

---

## setURL

---

### Declaration

```
void setURL(DBE HTMLView, string ID, string URL)
```

### Operation

Navigates the frame identified by *ID* to the given *URL*. The ID may be null.

---

## getURL

---

### Declaration

```
string getURL(DBE HTMLView, string ID)
```

### Operation

Returns the URL for the currently displayed frame as identified by its *ID*. The ID may be null.

---

## get(HTML view)

---

### Declaration

```
string get(DBE HTMLView)
```

### Operation

Returns the URL currently displayed in the given *HTMLView*, if there is one.

---

## get(HTML frame)

---

### Declaration

```
Buffer get(DBE HTMLView, string ID)
```

### Operation

Returns the URL for the currently displayed frame as identified by its *ID*.

---

## set(HTML view)

---

### Declaration

```
string set(DBE HTMLView, Buffer HTML)
```

### Operation

Sets the HTML fragment to be rendered inside the <body> tags by the HTML view control directly. This enables the controls HTML to be constructed dynamically and directly rendered.

---

## setHTML

---

### Declaration

```
string setHTML(DBE HTMLView, string ID, Buffer HTML)
```

### Operation

Sets the HTML fragment to be rendered inside the <body> tags by the HTML view controls frame as identified by ID. This enables the HTML of the given document or frame to be constructed dynamically and directly rendered.

**Note:** The contents of the frame being modified must be in the same domain as the parent HTML document to be modifiable. A DXL error will be given on failure (for example, if the wrong type of DBE is supplied).

---

## getHTML

---

### Declaration

```
Buffer getHTML(DBE HTMLView, string ID)
```

### Operation

Returns the currently rendered HTML fragment inside the <body> tags of the document or frame as identified by its *ID*.

---

## getBuffer

---

### Declaration

```
Buffer getBuffer(DBE HTMLView)
```

### Operation

Returns the currently rendered HTML.

---

## getInnerText

---

### Declaration

```
string getInnerText(DBE HTMLView, string ID)
```

### Operation

Returns the text between the start and end tags of the first object with the specified *ID*.

---

## setInnerText

---

### Declaration

```
void setInnerText(DBE HTMLView, string ID, string text)
```

### Operation

Sets the text between the start and end tags of the first object with the specified *ID*.

---

## getInnerHTML

---

### Declaration

```
string getInnerHTML(DBE HTMLView, string ID)
```

### Operation

Returns the HTML between the start and end tags of the first object with the specified *ID*.

---

---

## setInnerHTML

---

### Declaration

```
void setInnerHTML(DBE HTMLView, string ID, string html)
```

### Operation

Sets the HTML between the start and end tags of the first object with the specified *ID*.

**Note:** The `innerHTML` property is read-only on the `col`, `colGroup`, `framSet`, `html`, `head`, `style`, `table`, `tBody`, `tFoot`, `tHead`, `title`, and `tr` objects.

---

## getAttribute

---

### Declaration

```
string getAttribute(DBE element, string ID, string attribute)
```

### Operation

Retrieves the value for the requested attribute of the first object with the specified value of the *ID* attribute. If the attribute does not exist, null is returned.

Returns null on success. Returns error string on failure, for example if the wrong type of DBE is passed in.

---

## setAttribute

---

### Declaration

```
void setAttribute(DBE element, string ID, string attribute)
```

### Operation

Sets the value of the requested attribute for the first object with the specified value of the *ID* attribute. If the attribute does not exist, it is added to the object.

Displays a DXL error on failure, for example if the wrong type of DBE is passed in.

---

## Example

---

```
DB dlg
DBE htmlCtrl
DBE htmlBtn
DBE html

void onTabSelect(DBE whichTab){
```

```
        int selection = get whichTab
    }

void onSetHTML(DBE button){
    Buffer b = create
    string s = get(htmlCtrl)
    print s
    b = s
    set(html, b)
    delete b
}

void onGetInnerText(DBE button){
    string s = getInnerText(html, "Text")
    confirm(s)
}

void onGetInnerHTML(DBE button){
    string s = getInnerHTML(html, "Text")
    confirm(s)
}

void onGetAttribute(DBE button){
    string s = getAttribute(html, "Text", "Align")
    confirm(s)
}

void onSetInnerText(DBE button){
    Buffer b = create
    string s = get(htmlCtrl)
    setInnerText(html, "Text", s)
}

void onSetInnerHTML(DBE button){
```

```

    Buffer b = create
    string s = get(htmlCtrl)
    setInnerHTML(html, "Text", s)
}

void onSetAttribute(DBE button){
    Buffer b = create
    string s = getAttribute(html, "Text", "Align")
    if (s == "left"){
        s = "center"
    }
    else if (s == "center"){
        s = "right"
    }
    else if (s == "right"){
        s = "left"
    }

    setAttribute(html, "Text", "align", s)
}

bool onHTMLBeforeNavigate(DBE dbe, string URL, string frame, string body){
    string buttons[] = {"OK"}
    string message = "Before navigate - URL: " URL "\r\nFrame: " frame
"\r\nPostData: " body "\r\n"
    print message ""
    return true
}

void onHTMLDocComplete(DBE dbe, string URL){
    string buttons[] = {"OK"}
    string message = "Document complete - URL: " URL "\r\n"
    print message ""
    string s = get(dbe)
}

```



```

        print "url: " s "\r\n"
    }

bool onHTMLError(DBE dbe, string URL, string frame, int error){
    string buttons[] = {"OK"}
    string message = "Navigate error - URL: " URL "; Frame: " frame "; Error: "
error "\r\n"
    print message ""
    return true
}

void onHTMLProgress(DBE dbe, int percentage){
    string buttons[] = {"OK"}
    string message = "Percentage complete: " percentage "%\r\n"
    print message
    return true
}

dlg = create("Test", styleCentered | styleThemed | styleAutoparent)
htmlCtrl = text(dlg, "Field:", "<html><body>\r\n<p id=\"Text\"
align=\"center\">Welcome to <b>DOORS <i>ERS</i></b></p>\r\n</body></html>",
200, false)
htmlBtn = button(dlg, "Set HTML...", onSetHTML)
DBE getInnerTextBtn = button(dlg, "Get Inner Text...", onGetInnerText)
DBE getInnerHTMLBtn = button(dlg, "Get Inner HTML...", onGetInnerHTML)
DBE getAttributeBtn = button(dlg, "Get Attribute...", onGetAttribute)
DBE setInnerTextBtn = button(dlg, "Set Inner Text...", onSetInnerText)
DBE setInnerHTMLBtn = button(dlg, "Set Inner HTML...", onSetInnerHTML)
DBE setAttributeBtn = button(dlg, "Set Attribute...", onSetAttribute)

DBE frameCtrl = frame(dlg, "A Frame", 800, 500)

string strTabLabels[] = {"One", "Two"}
DBE tab = tab(dlg, strTabLabels, 800, 500, onTabSelect)

```

```
htmlCtrl->"top"->"form"
htmlCtrl->"left"->"form"
htmlCtrl->"right"->"unattached"
htmlCtrl->"bottom"->"unattached"
```

```
htmlBtn->"top"->"spaced"->htmlCtrl
htmlBtn->"left"->"form"
htmlBtn->"right"->"unattached"
htmlBtn->"bottom"->"unattached"
```

```
getInnerTextBtn->"top"->"spaced"->htmlCtrl
getInnerTextBtn->"left"->"spaced"->htmlBtn
getInnerTextBtn->"right"->"unattached"
getInnerTextBtn->"bottom"->"unattached"
```

```
getInnerHTMLBtn->"top"->"spaced"->htmlCtrl
getInnerHTMLBtn->"left"->"spaced"->getInnerTextBtn
getInnerHTMLBtn->"right"->"unattached"
getInnerHTMLBtn->"bottom"->"unattached"
```

```
getAttributeBtn->"top"->"spaced"->htmlCtrl
getAttributeBtn->"left"->"spaced"->getInnerHTMLBtn
getAttributeBtn->"right"->"unattached"
getAttributeBtn->"bottom"->"unattached"
```

```
setInnerTextBtn->"top"->"spaced"->htmlBtn
setInnerTextBtn->"left"->"aligned"->getInnerTextBtn
setInnerTextBtn->"right"->"unattached"
setInnerTextBtn->"bottom"->"unattached"
```

```
setInnerHTMLBtn->"top"->"spaced"->htmlBtn
setInnerHTMLBtn->"left"->"spaced"->setInnerTextBtn
setInnerHTMLBtn->"right"->"unattached"
setInnerHTMLBtn->"bottom"->"unattached"
```

```

setAttributeBtn->"top"->"spaced"->htmlBtn
setAttributeBtn->"left"->"spaced"->setInnerHTMLBtn
setAttributeBtn->"right"->"unattached"
setAttributeBtn->"bottom"->"unattached"

frameCtrl->"top"->"spaced"->setInnerTextBtn
frameCtrl->"left"->"form"
frameCtrl->"right"->"form"
frameCtrl->"bottom"->"form"

tab->"top"->"inside"->frameCtrl
tab->"left"->"inside"->frameCtrl
tab->"right"->"inside"->frameCtrl
tab->"bottom"->"inside"->frameCtrl

html = htmlView(dlg, 800, 500, "http://news.bbc.co.uk", onHTMLBeforeNavigate,
onHTMLDocComplete, onHTMLError, onHTMLProgress)

html->"top"->"inside"->tab
html->"left"->"inside"->tab
html->"right"->"inside"->tab
html->"bottom"->"inside"->tab

realize(dlg)
show(dlg)

```

---

## HTML Edit Control

The section describes the DXL support for the HTML edit control added in Rational DOORS 9.0.

The control behaves in many ways like a rich text area for entering formatted text. It encapsulates its own formatting toolbar enabling the user to apply styles and other formatting.

---

## htmlEdit

---

### Declaration

```
DBE htmlEdit(DB parentDB, string label, int width, int height)
```

### Operation

Creates an HTML editor control inside *parentDB*.

---

## htmlBuffer

---

### Declaration

```
Buffer getBuffer(DBE editControl)
```

### Operation

Returns the currently rendered HTML fragment shown in the control. The fragment includes everything inside the <body> element tag.

---

## set(HTML edit)

---

### Declaration

```
void set(DBE editControl, Buffer HTML)
```

### Operation

Sets the HTML to be rendered by the edit control. The HTML fragment should include everything inside, but not including, the <body> element tag.

---

## Example

---

```
DB MyDB = create "hello"
DBE MyHtml = htmlEdit(MyDB, "HTML Editor", 400, 100)

void mycb (DB dlg){

    Buffer b = getBuffer MyHtml
    string s = stringOf b
    ack s
}
```

```

apply (MyDB, "GetHTML", mycb)
set (MyHtml, "Initial Text")
show MyDB

```

---

## Miscellaneous

---

### delete(regex)

---

#### Declaration

```
void delete(Regex)
```

#### Operation

New in Rational DOORS 9.0 this perm deletes the supplied regular expression and frees the memory used by it.

---

### getURL

---

#### Declaration

```

string getURL(Database__ d)
string getURL(Module m)
string getURL(ModName_ modName)
string getURL(ModuleVersion modVer)
string getURL(Object o)
string getURL(Folder f)
string getURL(Project p)
string getURL(Item i)

```

#### Operation

Returns the Rational DOORS URL of the given parameter.

---

### backSlasher

---

#### Declaration

```
buffer backSlasher(Buffer b)
```

## Operation

This function takes a buffer and converts all forward-slash characters (/) to back-slash characters (\), eliminates any repeated back-slash characters, and removes any trailing back-slash characters.

## Example

```
string s = "\\directory////file "  
Buffer b = create  
b = s  
b = backSlasher(b)  
print b ""
```

## Chapter 10

# Fundamental types and functions

This chapter describes the functions and operators that can be used on the fundamental types of the core language underlying DXL:

- Operations on all types
- Operations on type `bool`
- Operations on type `char`
- Operations on type `int`
- Operations on type `real`
- Operations on type `string`

---

## Operations on all types

The concatenation operator and the functions `print` and `null` can be used with all fundamental types.

---

### Concatenation (base types)

---

The space character is the concatenation operator, which is shown as `<space>` in the following syntax:

```
bool b <space> string s
real r <space> string s
char c <space> string s
int i <space> string s
string s1 <space> string s2
```

---

For type	A space character
<code>bool</code>	Concatenates string <code>s</code> onto the evaluation of <code>b</code> ( <code>true</code> or <code>false</code> ), and returns the resulting string.
<code>real</code>	Concatenates string <code>s</code> onto real number <code>r</code> , and returns the resulting string.
<code>char</code>	Concatenates the string <code>s</code> onto the character <code>c</code> and returns the result as a string.
<code>int</code>	Concatenates the string <code>s</code> onto the integer <code>c</code> and returns the result as a string.
<code>string</code>	Concatenates string <code>s2</code> onto string <code>s1</code> and returns the result as a string.

---

Concatenation must be used when printing derived types. An example of a derived type is `o.` "Object text", where `o` is an object. If a string is not concatenated to the end of the print statement, a DXL error will occur, in this case.

### Example

```
print "square root of 2 is " (sqrt 2.0) "\n"
char nl = '\n'
print "line one" nl "line two"
print (getenv "DOORSHOME") "/lib/dxl"
print o."Object text" ""
```

---

## print (base types)

---

### Declaration

```
void print(bool x)
void print(real r)
void print(char c)
void print(int i)
void print(string s)
```

### Operation

For type	Prints
<code>bool</code>	The string <code>true</code> in the DXL output window if <code>x</code> is <code>true</code> ; otherwise prints <code>false</code> .
<code>real</code>	The passed real number <code>r</code> in the DXL output window, using a precision of 6 digits after the radix character.
<code>char</code>	The character <code>c</code> in the DXL output window.
<code>int</code>	Integer <code>i</code> in the DXL output window, with a trailing newline.
<code>string</code>	The string <code>s</code> in the DXL output window without a trailing newline.

### Example

```
print (2.2 * 2.2) // prints 4.840000
print 'a'
print "Hello world\n"
```

---

## null

---

The `null` function either returns the null value for the type, or tests whether a variable has the null value for its type.



## Declaration

```
type null()
bool null(type x)
```

## Operation

The first form returns the following values depending on the value of *type*:

Type	Return value
bool	false
char	character of ASCII code 0
int	0
real	0.000000
string	a null string ("")

The second form returns `true` if *x* has a null value as follows:

Type	Null value
bool	false or null
char	null
int	0 or null
real	Any 0 value with any number of decimal places or null
string	"" or null

You can use the value `null` to assign a null value to any type, including type `bool` and `char`.

## Example

```
string empty = null
print null empty // prints true
```

---

## Operations on type bool

Just as C++ has introduced a separate type `bool` (for boolean), so has DXL.

See also “Concatenation (base types),” on page 113, the `print` function, and the `null` function.

---

## Type bool constants

---

The following constants are declared:

```
const bool true
const bool on
const bool false
const bool off
```

The boolean value `true` is equivalent to `on`; the value `false` is equivalent to `off`.

**Note:** For boolean values you cannot use `1` and `0`.

---

## Boolean operators

---

The operators `&&`, `||`, and `!` perform logical AND, OR, and NOT operations, as shown in the following syntax:

```
bool x && bool y
bool x || bool y
!bool x
```

These operators use lazy evaluation.

The `&&` operator returns `true` only if `x` and `y` are both `true`; otherwise, it returns `false`. If `x` is `false`, it does not evaluate `y`.

The `||` operator returns `true` if `x` or `y` is `true`; otherwise, it returns `false`. If `x` is `true`, it does not evaluate `y`.

The `!` operator returns the negation of `x`.

---

## Type bool comparison

---

Type `bool` relational operators can be used as shown in the following syntax:

```
bool x == bool y
bool x != bool y
```

The `==` operator returns `true` only if `x` and `y` are equal; otherwise, it returns `false`.

The `!=` operator returns `true` only if `x` and `y` are not equal; otherwise, it returns `false`.

---

## Operations on type char

See also “Concatenation (base types),” on page 113, the `print` function, and the `null` function.

---

## Character comparison

---

Character relational operators can be used as shown in the following syntax:

```
char ch1 == char ch2
char ch1 != char ch2
char ch1 < char ch2
char ch1 > char ch2
char ch1 <= char ch2
char ch1 >= char ch2
```

These operators return `true` if *ch1* is equal, not equal, less than, greater than, less than or equal to, or greater than or equal to *ch2*.

---

## Character extraction from string

---

The index notation, [ ], can be used to extract a single character from a string, as shown in the following syntax:

```
string text[int n]
```

This returns the *n*<sup>th</sup> character of string *text*, counting from 0.

### Example

This example prints h in the DXL Interaction window's output pane:

```
string s = "hello"
char c = s[0]
print c
```

---

## Character classes

---

The set of functions whose names start with `is` can be used to check whether a character belongs to a specific class.

### Declaration

```
bool isalpha(char ch)
bool isupper(char ch)
bool islower(char ch)
bool isdigit(char ch)
bool isxdigit(char ch)
bool isalnum(char ch)
bool isspace(char ch)
```

```
bool ispunct(char ch)
bool isprint(char ch)
bool iscntrl(char ch)
bool isascii(char ch)
bool isgraph(char ch)
```

## Operation

These functions return `true` if the character `ch` is in the named character class:

Class	Description
<code>alpha</code>	'a' - 'z' 'A' - 'Z'
<code>upper</code>	'A' - 'Z'
<code>lower</code>	'a' - 'z'
<code>digit</code>	'0' - '9'
<code>xdigit</code>	'0' - '9' 'a' - 'f' 'A' - 'F'
<code>alnum</code>	'a' - 'z' 'A' - 'Z' '0' - '9'
<code>space</code>	' ' '\t' '\n' '\m' '\j' '\k'
<code>punct</code>	any character except <space> and alpha numeric characters
<code>print</code>	a printing character
<code>cntrl</code>	any character code between 0 and 31, and code 127
<code>ascii</code>	any character code between 0 and 127
<code>graph</code>	any visible character

## Example

```
print isalpha 'x' // prints true
print isalpha ' ' // prints false
```

---

## charOf

---

### Declaration

```
char charOf(int asciiCode)
```

### Operation

Returns the character whose ASCII code is *asciiCode*.

## Example

```
const char nl = charOf 10
```

---

## intOf (char)

---

### Declaration

```
int(char ch)
```

### Operation

Returns the ASCII code of character *ch*.

### Example

```
print intOf 'a' // prints 97
```

---

## Operations on type int

A type `int` value in DXL has at least 32 bits.

See also “Concatenation (base types),” on page 113, the `print` function, and the `null` function.

---

## Arithmetic operators (int)

---

Arithmetic operators can be used as shown in the following syntax:

```
int x + int y
```

```
int x - int y
```

```
int x * int y
```

```
int x / int y
```

```
int x % int y
```

```
int x | int y
```

```
int x & int y
```

```
~int x
```

```
-int x
```

These operators perform integer arithmetic operations for addition, subtraction, multiplication, division, remainder, bitwise OR, bitwise AND, bitwise NOT, and negation.

---

## Assignment (int)

---

Assignment operators can be used as shown in the following syntax:

```
int x = int y
int x += int y
int x -= int y
int x *= int y
int x /= int y
int x %= int y
int x |= int y
int x &= int y
```

These operators assign integer values to variables of type `int` assignment. The last seven variations combine an arithmetic operation with the assignment.

### Example

```
int y = 20
y *= 3
print y      // print 60
y /= 7
print y      // print 8
y %= 3
print y      // print 2
```

---

## Unary operators

---

Unary operators can be used to increment or decrement variables before or after their values are accessed, as shown in the following syntax:

```
int x++
int x--
int ++x
int --x
```

The first two operators return the value of the variable before incrementing or decrementing a variable. The second two return the value after incrementing or decrementing a variable.

**Note:** You can overload these operators.

### Example

```
int i = 40
print ++i      // prints 41
print i++     // prints 41
print i       // prints 42
```

---

## Minimum and maximum operators

---

Two operators can be used to obtain the minimum or maximum value from a pair of integers, as shown in the following syntax:

```
int x <? int y
int x >? int y
```

These operators return the minimum or maximum of integers *x* and *y*.

### Example

```
print (3 <? 2)    // prints 2
print (3 >? 2)    // prints 3
```

---

## Integer comparison

---

Integer relational operators can be used as shown in the following syntax:

```
int x == int y
int x != int y
int x < int y
int x > int y
int x <= int y
int x >= int y
```

These operators return `true` if *x* is equal, not equal, less than, greater than, less than or equal to, or greater than or equal to *y*.

### Example

```
print (2 != 3) // prints true
```

---

## isValidInt

---

### Declaration

```
bool isValidInt(string value)
```

## Operation

Returns `true` if *value* is a valid integer; otherwise, returns `false`. The value passed must not be just spaces, e.g. `" "`. If a null string is passed, a DXL run-time error occurs.

## random(int)

### Declaration

```
int random(int max)
```

### Operation

Returns a random integer value *x* such that  $0 \leq x < \text{max}$

### Example

```
print random 100 // prints an integer in the range 0 to 99
```

## Operations on type real

A type `real` value in DXL is like a type `double` in C, with a precision of 64 bits.

See also “Concatenation (base types),” on page 113, the `print` function, and the `null` function.

## Type real pi

The only constant of type `real` that is declared in DXL is `pi`:

```
const real pi
```

This supplies a constant value of 3.141593.

## Arithmetic operators (real)

Arithmetic operators can be used as shown in the following syntax:

```
real x + real y
```

```
real x - real y
```

```
real x * real y
```

```
real x / real y
```

```
real x ^ real y
```

```
-real x
```



## Operation

These operators perform arithmetic operations on type `real` variables for addition, subtraction, multiplication, division, exponentiation, and negation.

### Example

```
print (2.2 + 3.3)      // prints 5.500000
```

## Assignment (real)

Assignment operators can be used as shown in the following syntax:

```
real x = real y
real x += real y
real x -= real y
real x *= real y
real x /= real y
```

These operators perform type `real` assignment. The last four variations combine an arithmetic operation with the assignment.

### Example

```
real x = 1.1
print (x += 2.0)      // prints 3.1
```

After the `print` statement, the variable `x` is assigned the value `3.1`.

## Convert to real

The assignment operator `=` can be used to convert an integer to a real number, as shown in the following syntax:

```
real r = int i
```

### Operation

Converts `i` into a type `real`, assigns it to the type `real` variable `r`, and returns this value.

### Example

```
real r = 5
print r              // prints 5.000000
```

## Type real comparison

Type `real` relational operators can be used as shown in the following syntax:

```
real x == real y
```

```

real x != real y
real x < real y
real x > real y
real x <= real y
real x >= real y

```

These operators return `true` if `x` is equal, not equal, less than, greater than, less than or equal to, or greater than or equal to `y`.

### Example

```
print (2.2 < 4.0)      // prints true
```

## intOf (real)

### Declaration

```
int intOf(real r)
```

### Operation

Rounds `r` of type `real` to the nearest integer.

### Example

```
print intOf 3.2      // prints 3
```

## realOf

### Declaration

```
real realOf(int i)
real realOf(string s)
```

### Operation

Converts type `int` `i` or type `string` `s` into a type `real` value, and returns it.

### Example

```

print realOf 4          // prints 4.000000
real x = realOf "3.2"
print x                 // prints 3.200000

```

---

**cos**

---

**Declaration**

```
real cos(real angle)
```

**Operation**

Returns the cosine of *angle* in radians.

---

**sin**

---

**Declaration**

```
real sin(real angle)
```

**Operation**

Returns the sine of *angle* in radians.

---

**tan**

---

**Declaration**

```
real tan(real angle)
```

**Operation**

Returns the tangent of *angle* in radians.

---

**exp**

---

**Declaration**

```
real exp(real x)
```

**Operation**

Returns the natural exponent of type real *x*.

---

**log**

---

**Declaration**

```
real log(real x)
```

**Operation**

Returns the natural logarithm of type real *x*.

---

---

## pow

---

### Declaration

```
real pow(real x,  
         real y)
```

### Operation

Returns type `real` `x` raised to the power `y` (same as  $x^y$ ).

---

## sqrt

---

### Declaration

```
real sqrt(real x)
```

### Operation

Returns the square root of `x`.

---

## random(real)

---

### Declaration

```
real random()
```

### Operation

Returns a random value `x`, such that  $0 \leq x < 1$ .

---

## Operations on type string

A DXL type `string` can contain any number of characters.

See also “Concatenation (base types),” on page 113, the `print` function, and the `null` function.

---

## String comparison

---

String relational operators can be used as shown in the following syntax:

```
string s1 == string s2  
string s1 != string s2  
string s1 < string s2
```

```
string s1 > string s2
string s1 <= string s2
string s1 >= string s2
```

These operators return `true` if `s1` is equal, not equal, less than, greater than, less than or equal to, or greater than or equal to `s2`. Case is significant.

### Example

```
print ("aaaa" < "a"      ) // prints "false"
print ("aaaa" > "a"      ) // prints "true"
print ("aaaa" == "a"     ) // prints "false"
print ("A" > "a"         ) // prints "false"
print ("McDonald" < "Man" ) // prints "false"
```

---

## Substring extraction from string

---

The index notation, `[ ]`, can be used to extract a substring from a string, as shown in the following syntax:

```
string text[range]
```

### Operation

Returns a substring of `text` as specified by `range`, which must be in the form `int:int`.

The `range` argument is specified as the indices of the first and last characters of the desired substring, counting from 0. If the substring continues to the end of the string, the second index can be omitted.

### Example

```
string str = "I am a string constant"
print str[0:3] // prints "I am"
print str[2:3] // prints "am"
print str[5:]  // prints "a string constant"
```

---

## cistrcmp

---

### Declaration

```
int cistrcmp(string s1,
            string s2)
```

### Operation

Compares strings `s1` and `s2` without regard to their case, and returns:

```
0      if      s1 == s2
```

```
1     if     s1 > s2
-1    if     s1 < s2
```

### Example

```
print cistrcmp("aAa", "AaA") // prints 0
print cistrcmp("aAa", "aA") // prints 1
print cistrcmp("aAa", "aAaa") // prints -1
```

---

## length

---

### Declaration

```
int length(string str)
```

### Operation

Returns the length of the string *str*.

### Example

```
print length "123" // prints 3
```

---

## lower, upper

---

### Declaration

```
string lower(string str)
```

```
string upper(string str)
```

### Operation

Converts and returns the contents of *str* into lower or upper case.

### Example

```
string mixed = "aaaBBBBcccc"
print lower mixed // prints "aaabbbbcccc"
print upper mixed // prints "AAABBBCCCC"
```

---

## soundex

---

### Declaration

```
string soundex(string str)
```

## Operation

Returns the soundex code of the string *str*. Initial non-alphabetic characters of *str* are ignored.

Soundex codes are identical for similar-sounding English words.

## Example

Both these examples print R265 in the DXL Interaction window's output pane.

```
print (soundex "requirements")
print (soundex "reekwirements")
```

## backSlasher

### Declaration

```
buffer backSlasher(Buffer b)
```

### Operation

This function takes a buffer and converts all forward-slash characters (/) to back-slash characters (\), eliminates any repeated back-slash characters, and removes any trailing back-slash characters.

### Example

```
string s = "\\directory\\\\file "
Buffer b = create
b = s
b = backSlasher(b)
print b ""
```

## findPlainText

### Declaration

```
bool findPlainText(string s, string sub, int &offset, int &length, bool
matchCase[, bool reverse])
```

### Operation

Returns true if string *s* contains the substring *sub*.

Both *s* and *sub* are taken to be plain text string. Use *findRichText* to deal with strings containing RTF markup.

If *matchCase* is true, string *s* must contain string *sub* exactly with matching case; otherwise, any case matches.

The function returns additional information in *offset* and *length*. The value of *offset* is the number of characters in *s* to the start of the first match with string *sub*. The value of *length* contains the number of characters in the matching string.

If *reverse* is specified and is true, then the search is started at the end of the string, and the returned values of *offset* and *length* will reflect the last matching string in *s*.

### Example

```
string s = "This shall be a requirement"
string sub = "shall"

int offset = null
int length = null

bool matchCase = true
bool reverse = true

if (findPlainText (s, sub, offset, length, matchCase, reverse)){
    print offset " : " length "" \\prints "5 : 5"
}
```

---

## unicodeString

---

### Declaration

```
string unicodeString(RTF_string__ str, bool convertAllSymbols, bool
returnAsPlainText)
```

### Operation

Returns the value of the specified rich text string as RTF or plain text. If the attribute contains characters in Symbol font, these characters are converted to the Unicode equivalents.

If *convertAllSymbols* is true, all symbol character are converted. If false, only Unicode characters that have a good chance of being displayed are used. See the `symbolToUnicode` perm for a description of which characters are converted.

The value is returned as plain text if *returnAsPlainText* is true. Otherwise the value is returned as RTF.

---

## escape

---

### Declaration

```
string escape(string str, char escapeChar, string escapeChars)
```

### Operation

Escapes all the characters in *str* which are in *escapeChars*, with the *escapeChar* character. This also escapes *escapeChar* itself.



## Example

`escape("hello world", '/', "l")` returns `"he/l/lo wor/ld"`

`escape("hello world #1", '#', "lh")` returns `"#he#l#lo wor#ld ##1"`

---

## stripPath

---

### Declaration

```
string stripPath(string path, bool isEscaped)
```

### Operation

Removes the path part from path, using forward slash as the path separator.

If *isEscaped* is true, the slash character can be used as a literal character rather than a path separator by preceding the character with a backslash.

### Example

`stripPath("abc/def/ghi", b)` returns `"ghi"`, where *b* is true or false.

`stripPath("abc/def\\/ghi", true)` returns `"def/ghi"`



## Chapter 11

# General language facilities

This chapter introduces basic functions and structures defined by DXL's run-time environment, as follows:

- Files and streams
- Configuration file access
- Dates
- Skip lists
- Regular expressions
- Text buffers
- Arrays

---

## Files and streams

This section describes DXL's features for manipulating files. For information on creating a directory, see the `mkdir` function.

The main data type introduced is the `Stream`, which uses C++ like overloads of `>>` and `<<` to read and write files. Streams are not a fundamental type inherited from DXL's C origins, so the type name `Stream` begins with an upper case letter.

---

## Standard streams

---

### Declaration

```
Stream& cin
```

```
Stream& cout
```

```
Stream& cerr
```

### Operation

Following C++'s naming scheme for UNIX standard streams, these variables are initialized by Rational DOORS to standard input, output and error.

On UNIX platforms, you can use `cin` to read input that has been piped into Rational DOORS, and `cout` to pipe data out from Rational DOORS. Similarly, you can send user defined error messages (or any other desired output) to standard error using `cerr`.

---

## Read from stream

---

The operator `>>` can be used to read strings or data from a configuration area stream, or fill a buffer, as shown in the following syntax:

```
file >> string s
```

```
file >> char c
```

```
file >> real r
```

```
file >> int i
```

```
file >> Buffer b
```

where:

*file* is a file of type `Stream`

The first form reads a line of text from the configuration area stream *file* into string *s*, up to but not including any newline.

The next three forms read the data from the configuration area stream *file*, and return the result as a stream, to enable chained reads. Real and integer constants are expected to be the last items on a line, while characters, including newlines, are read one at a time up to and including the end of file.

The second form reads from the configuration area stream *file* into buffer *b* until it is full at its current size, or the end of the file is reached. Returns the configuration area stream. This function can read multiple lines.

### Example

```
char    c
```

```
real    r
```

```
int     i
```

```
Stream input = read "data.dat"
```

```
input >> c >> r >> i
```

---

## Read line from stream

---

Two operators can be used to read a single line from a stream to a buffer, as shown in the following syntax:

```
file -> Buffer b
```

```
file >= Buffer b
```

where:

*file* is a file of type `Stream`

### Operation

The `->` operator reads a single line from the stream *file*, and copies it to the buffer, skipping any leading white space. If the line is empty besides white space, the buffer is emptied. Returns the stream.

The `>=` operator reads a single line from the stream *file*, and copies it to the buffer in its entirety. If the line is empty, the buffer is emptied. Returns the stream.

---

## Write to stream

---

The operator `<<` can be used to write strings, single characters or buffers to a stream, as shown in the following syntax:

```
file << string s
```

```
file << char c
```

```
file << Buffer b
```

where:

*file* is a file of type Stream

Writes the string *s*, the character *c*, or the buffer *b* to the stream file. To write other data types to a stream, first convert them to a string by concatenating the empty string or a newline.

### Example

```
Stream out = write tempFileName
```

```
out << 1.4 "\n"
```

```
Stream alpha = write tempFileName
```

```
alpha << 'a' << 'b' << 'c'
```

---

## canOpenFile

---

### Declaration

```
bool canOpenFile(string pathname,
                 bool forWrite)
```

### Operation

Returns `true` when the file *pathname* can be opened; otherwise, returns `false`. If *forWrite* is set to `true`, the file is opened for write and the current contents of the file are cleared. If *forWrite* is set to `false` the file is opened read only and the existing contents are unchanged.

---

## read, write, append(open file)

---

### Declaration

```
Stream read(string filename)
```

```
Stream write(string filename)
```

```
Stream append(string filename)
```

## Operation

Opens a file *filename* for reading, writing or appending, and returns a stream. File I/O operations only succeed if the user has permission to create or access the files specified.

To open a binary file, you must call the `binary` function after the `read`, `write` or `append`. The syntax is therefore:

```
read [binary] filename
write [binary] filename
append [binary] filename
```

You can use the `Stat DXL` functions to check whether the I/O functions in this section can succeed (see “user, size, mode,” on page 183).

## Example

```
// ASCII file
Stream output = write tempFileName
// binary file
Stream image = read binary pictureFileName
```

## close(stream)

### Declaration

```
void close(Stream s)
```

### Operation

Closes the stream *s*.

## flush

### Declaration

```
void flush(Stream s)
```

### Operation

Flushes the output stream *s*. Character I/O can be buffered; this command forces any such buffers to be cleared.

## readFile

### Declaration

```
string readFile(string filename)
```

### Operation

Returns the contents of the file *filename* as a string.

**Note:** The Codepages function also has a `readFile` operator. For information about Codepages and `readFile`, see “`readFile`,” on page 207.

---

## goodFileName

---

### Declaration

```
string goodFileName(string filename)
```

### Operation

Returns a legitimate file name of the passed file, *filename*, with respect to any restrictions imposed by the current platform. This will only apply to the filename up to the ‘.’ character. The string after the ‘.’ is ignored.

This function does not support non-English Unicode characters.

### Example

This example prints the file name `Test_results` in the DXL output window:

```
print goodFileName "Test results"
```

---

## tempFileName

---

### Declaration

```
string tempFileName()
```

### Operation

Returns a string, which is a legal file name on the current platform, and is not the name of an existing file. On UNIX platforms, returns a file name like `/tmp/DOORSaaouef`; on Windows platforms, returns a file name like `C:\TEMP\DP2`. This file can be used for temporary storage by DXL programs.

---

## currentDirectory

---

### Declaration

```
string currentDirectory()
```

### Operation

Returns the path name of the current working directory.

---

## copyFile

---

### Declaration

```
string copyFile(string sourceFileName,
                string destFileName)
```

## Operation

Copies file *sourceFileName* to *destFileName*. If the operation succeeds, returns `null`; otherwise, returns an error message.

## Example

```
copyFile("file1", "file2")
```

## deleteFile

### Declaration

```
string deleteFile(string filename)
```

### Operation

Deletes the file named *filename*. If the operation succeeds, returns `null`; otherwise, returns an error message.

## renameFile

### Declaration

```
string renameFile(string old, string new)
```

### Operation

Renames the file called *old* to *new*. If the operation succeeds, returns `null`; if it fails, returns an error message.

## end(stream)

### Declaration

```
bool end(Stream s)
```

### Operation

Returns `true` if the stream has no more characters pending. The test should be made after a read, but before the read data is used:

### Example

```
while (true) {
    input >> str          // read a line at a time; var set up
    if (end input) break // test after read but before
    print str "\n"       // variable str is used
}
```



---

## format

---

### Declaration

```
void format(Stream s, string text, int width)
```

### Operation

Outputs string *text* to Stream *s*, formatting each word of the text with a ragged right margin in a column of *width* characters. If a word is too long for the specified column, it is continued on the next line.

### Example

```
Stream out = write tempFileName
format(out, "DXL Reference Manual", 5)
close out
```

This generates the following in the temporary file:

```
DXL
Refer
ence
Manua
l
```

---

## for file in directory

---

### Syntax

```
for s in directory "pathname" do {
  ...
}
```

where:

<i>pathname</i>	is the path of the directory
<i>s</i>	is a string variable

### Operation

Sets the string *s* to be each successive file name found in the directory *pathname*.

### Example

This example prints a list of the files in directory C:\:

```
string x = "c:\\\"
string file
```

```

for file in directory x do {
    print file "\n"
}

```

---

## Files and streams example program

---

This example creates a temporary file, writes some data to it, saves it, renames it, reads from the new file, and then deletes it:

```

// file (Stream) DXL example
/*
  example file I/O program
*/
string filename = tempFileName // get a scratch file
print "Writing to " filename "\n"
Stream out = write filename
out << 'x' "" // write a char (via a string)
out << 1.001 "\n" // a real (must be last thing on line)
out << 42 "\n" // an int (must be last thing on line)
out << "hello world\na second line\n"
// a string
close out // write a file to read back in again
string oldName = filename
filename = tempFileName // get a new file name
renameFile(oldName, filename) // move the file we wrote earlier
print "Reading from " filename "\n"
Stream input = read filename
char c // declare some variable
real r
int i
input >> c
input >> r
input >> i
print c " " r " " i "\n" // check data type read/writes
string str // do rest line by line
while (true) {
    input >> str // read a line at a time
}

```

```

        if (end of input) break
        print str "\n"          // str does not include the newline
    }
print readfile filename      // read the whole lot into a string
close input
deletefile filename         // delete the file

```

---

## Configuration file access

This section describes the DXL features for manipulating configuration files. The data types used are `ConfType` and `ConfStream`. Many of these functions have a parameter `ConfType area`. The arguments that can be passed as `ConfType area` are as follows:

- `confUser`
- `confSysUser`
- `confSystem`
- `confTemp`

The `confUser` argument means the file is situated in an area specific to the current Rational DOORS user, or to the current system user if a project is not open.

The `confSysUser` argument means the file is situated in the configuration area for system users. This argument remains constant regardless of whether the user is logged into the project. For example, the Rational DOORS Tip Wizard uses a `confSysUser` file to store whether a user has opted to show Tips on startup.

The `confSystem` argument means the file is situated in a shared area accessible by all users.

The `confTemp` argument is similar to `confSystem`, but is generally used for storing temporary files.

If the function does not supply an `area` argument, `confUser` is used.

---

## Read from stream

---

The operator `>>` can be used to read strings or data from a configuration area stream, or fill a buffer, as shown in the following syntax:

```
file >> string s
```

```
file >> Buffer b
```

where:

*file* is a file of type `ConfStream`

The first form reads a line of text from the configuration area stream *file* into string *s*, up to but not including any newline.

The second form reads from the configuration area stream *file* into buffer *b* until it is full at its current size, or the end of the file is reached. Returns the configuration area stream. This function can read multiple lines.

---

## Read line from stream

---

Two operators can be used to read a single line from a configuration stream to a buffer, as shown in the following syntax:

```
file -> Buffer b
```

```
file >= Buffer b
```

where:

*file* is a file of type `ConfStream`

### Operation

The `->` operator reads a single line from the configuration area stream *file*, and copies it to the buffer, skipping any leading white space. If the line is empty besides white space, the buffer is emptied. Returns the stream.

The `>=` operator reads a single line from the configuration area stream *file*, and copies it to the buffer in its entirety. If the line is empty, the buffer is emptied. Returns the stream.

---

## Write to stream

---

The operator `<<` can be used to write strings, single characters or buffers to a stream, as shown in the following syntax:

```
file << string s
```

```
file << char c
```

```
file << Buffer b
```

where:

*file* is a file of type `ConfStream`

Writes the string *s*, the character *c*, or the buffer *b* to the configuration area stream *file*. To write other data types to a configuration area stream, first convert them to a string by concatenating the empty string or a newline.

### Example

```
ConfStream out = write tempFileName
```

```
out << 1.4 "\n"
```

```
ConfStream alpha = write tempFileName
```

```
alpha << 'a' << 'b' << 'c'
```

---

## confMkdir

---

### Declaration

```
void confMkdir(string dirName  
                [,ConfType area])
```

## Operation

Creates the directory, *dirName*, in either the default or the specified configuration area, *area*.

## confDeleteDirectory

### Declaration

```
string confDeleteDirectory(string pathname, ConfType conf)
```

### Operation

Deletes the named directory in the specified *ConfType* area (*confSystem* or *confUser*). On success it returns null; on failure it returns an error string.

## confRead

### Declaration

```
ConfStream confRead(string fileName
                    [,ConfType area])
```

### Operation

Opens the specified file for reading, and returns the file handle. The file can be in either the default or the specified configuration area.

Detects the encoding of conf files by checking for the presence of a UTF-8 Byte Order Marker (BOM) at the start of the file. If it finds one, it assumes that the file is encoded in UTF-8. Otherwise, it assumes that the file is encoded according to the legacy codepage for the database. In either case, any values subsequently read from the file using the `ConfStream >>` operator or others are converted to Unicode, so the encoding of the file should not affect the functionality of any DXL scripts that use this perm.

## confWrite

### Declaration

```
ConfStream confWrite(string fileName
                    [,ConfType area])
```

### Operation

Opens the specified file for writing, and returns the file handle. The file can be in either the default or the specified configuration area.

Any conf files created by this perm are encoded in UTF-8, enabling them to contain any Unicode strings.

---

## confAppend

---

### Declaration

```
ConfStream confAppend(string fileName
                      [,ConfType area])
```

### Operation

Opens the specified file for appending, and returns the file handle. The file can be in either the default or the specified configuration area.

This perm converts any non-UTF-8 files to UTF-8 encoding before opening them for append. This enables any Unicode strings to be written to the file using the ConfStream << write operators.

---

## confRenameFile

---

### Declaration

```
string confRenameFile(string old,
                     string new
                     [,ConfType area])
```

### Operation

Renames the file *old* to *new* in either the default or the specified configuration area.

Returns an error message string if the operation fails.

---

## confCopyFile

---

### Declaration

```
string confCopyFile(string source,
                   string dest,
                   ConfType area)
```

### Operation

Copies *source* to *dest* in the specified configuration area. If the operation fails, it returns an error message.

---

## confDeleteFile

---

### Declaration

```
string confDeleteFile(string fileName
                     [,ConfType area])
```

## Operation

Deletes the specified file in either the default or the specified configuration area. If the operation fails, it returns an error message.

## confFileExists

### Declaration

```
bool confFileExists(string fileName
                   [,ConfType area])
```

### Operation

Returns `true` if the specified file exists in either the default or the specified configuration area; otherwise, returns `false`.

## close(configuration area stream)

### Declaration

```
void close(ConfStream s)
```

### Operation

Closes the configuration area stream `s`.

## end(configuration area stream)

### Declaration

```
bool end(ConfStream s)
```

### Operation

Returns `true` if the stream has no more characters pending. The test should be made after a read, but before the read data is used:

### Example

```
while (true) {
    input >> str           // read a line at a time; var set up
    if (end input) break // test after read but before
    print str "\n"       // variable str is used
}
```

---

## for file in configuration area

---

### Syntax

```
for s in confDirectory("dirname" [, area]) do {
    ...
}
```

where:

<i>dirname</i>	is the name of the directory in <i>area</i> , or if <i>area</i> is omitted, in <code>confUser</code>
<i>area</i>	is a constant of type <code>ConfType</code> : <code>confUser</code> , <code>confSysUser</code> , <code>confSystem</code> , <code>confTemp</code> , or <code>confProjUser</code>
<i>s</i>	is a string variable

### Operation

Sets the string *s* to be each successive file name found in the directory *pathname*.

### Example

This example prints a list of the files in directory `test` in `confUser`:

```
string file
for file in confDirectory("test") do {
    print file "\n"
}
```

---

## confUploadFile(source, dest [, conftype])

---

### Declaration

```
string confUploadFile(string source, string dest [, conftype])
```

### Operation

Uploads a file from the location on the client machine specified by *source*, to the file in the system conf area on the database server, specified by *dest*. It returns null on success. If the *dest* string contains double-periods `..` or specifies an invalid directory, then the perm reports an error and returns null. Otherwise, if the upload fails, the perm returns an error message.

The optional 3rd argument specifies the config area where the file should be sent. This defaults to the current user's config area (`confUser`). Files to be accessible to all users should be uploaded to the system config area, by specifying this argument as `"confSystem"`.

### Example

```
string message = confUploadFile("C:\\temp\\myprog.exe", "myprog", confSystem)
```



```

if (!null message)
{
    warningBox (message)
}

```

---

## confDownloadFile(source, dest [, conftype])

---

### Declaration

```
string confDownloadFile(string source, string dest [, conftype])
```

### Operation

Downloads a file from the location in the conf area on the database server, specified by *dest*, to the location on the client machine specified by *source*. It returns null on success. If the source string contains double-periods “.” then the perm reports an error and returns null. Otherwise, if the download fails, the perm returns an error message.

The optional 3rd argument specifies the config area from which the file should be copied. This defaults to the current user's config area (confUser).

### Example

```

string message = confDownloadFile("myprog", "C:\\temp\\myprog2.exe", confSystem)
if (!null message)
{
    warningBox (message)
}

```

---

## Dates

This section describes DXL's features for manipulating dates.

Dates are not a fundamental type inherited from DXL's C origins, so the type name `Date` begins with an upper case letter.

DXL `Date` data limits are from 1 Jan 1970, to 31 Dec 2102.

---

### Concatenation (dates)

---

The space character is the concatenation operator, which is shown as `<space>` in the following syntax:

```
Date d <space> string s
```

Concatenates string *s* onto date *d* and returns the result as a string. It uses the long format date, or, if any operations dealing in seconds have occurred, the short format date with time added.

## Example

This example prints <01 January 1999>:

```
Date d = "1 Jan 99"
print "<"d">"
```

---

## Assignment (date)

---

The assignment operator = can be used as shown in the following syntax:

```
Date d = string datestr
```

Converts the string *datestr* into a date, assigns it to *d*, and returns it as a result. Issues an error message if *datestr* is not in a valid date format. Ordinal numbers, for example 4th, are not recognized. Apart from that limitation, all date formats are valid, for example:

```
yyyy, dd mmm
```

```
dd/mm/yy
```

```
mm/dd/yy
```

Time can be appended to a dates using the format *hh:mm:ss.ss*, provided the date is in the format *dd/mm/yy* or *mm/dd/yy*.

## Example

This example prints 04 October 1961:

```
Date d1 = "4 Oct 1961"
print d1
```

---

## Date comparison

---

Date relational operators can be used as shown in the following syntax:

```
Date d1 == Date d2
```

```
Date d1 != Date d2
```

```
Date d1 < Date d2
```

```
Date d1 > Date d2
```

```
Date d1 <= Date d2
```

```
Date d1 >= Date d2
```

These operators return `true` if *d1* is equal, not equal, less than, greater than, less than or equal to, greater than or equal to *d2*.

## Example

This example prints `false` in the DXL Interaction window's output pane:

```
Date d1 = "4 Oct 1961"
```

```
Date d2 = "10 Nov 1972"
print (d1 > d2)
```

---

## print(date)

---

### Declaration

```
void print(Date d)
```

### Operation

Prints the date *d* in the DXL output window in long format, or, if any operations dealing in seconds have occurred, the short format date with time added.

### Example

This example prints 04 October 1961:

```
Date d1 = "4 Oct 1961"
print d1
```

---

## today

---

### Declaration

```
Date today()
```

### Operation

Returns today's date. The value includes the exact time, but it is not printed using:

```
print today
```

The function call:

```
intOf today
```

returns the integer number of seconds since 1 Jan 1970, 00:00:00 GMT.

### Example

This example prints the current date and time:

```
print dateOf intOf today
```

**Note:** Concatenating strings to the end of this statement may give unexpected results.

---

## session

---

### Declaration

```
Date session()
```

## Operation

Returns the date on which the current Rational DOORS session began. The value includes the exact time in the same way as the `today` function.

## Example

This example prints the date the current Rational DOORS session started:

```
print session
```

## intOf(date)

### Declaration

```
int intOf(Date d)
```

### Operation

Returns an integer corresponding to the number of seconds that have elapsed between the given date and 1 Jan 1970, 00:00:00 GMT.

When a `Date` data type is converted for dates on or after 1 Jan 2037, or before 1 Jan 1970, this function returns a result of -1.

### Example

```
print intOf today
```

## dateOf

### Declaration

```
Date dateOf(int secs)
```

### Operation

Returns the date and time that is calculated as `secs` seconds since 1 Jan 1970, 00:00:00 GMT.

### Example

```
int minute    = 60
int hour      = 60 * minute
int day       = 24 * hour
int year      = 365 * day
int leapYear  = 366 * day
print dateOf ((year * 2) + leapYear)
```

This generates the following in the DXL Interaction window's output pane:

```
01/01/73 00:00:00
```

This is three years after 1 Jan 1970, 00:00:00 GMT, taking into account that 1972 was a leap year.

---

## stringOf

---

### Declaration

```
string stringOf(Date d[, Locale l][, string s] )
```

### Operation

This returns the string representation of the date value using the specified locale and format. If no locale is specified, the current user locale is used. If no format string or a null format string is specified, then if the date value includes time (hours:minutes:seconds), the default short date format for the locale will be used. Otherwise, a long date format will be used. The default short date format will be either that specified by the user using `setDefaultFormat(Locale)`, or, if no default short date format has been set by the user for the locale, the system default format.

---

## date

---

### Declaration

```
Date date(string s[, Locale l][,string s])
```

### Operation

This returns the date value represented by the supplied string, interpreted according to the specified locale and format. The default locale is the current user locale. If no format string is supplied, the input string is parsed using first the user's default short date format (if one has been specified for the locale), and then all the supported formats for the locale.

---

## for string in shortDateFormats

---

### Declaration

```
for string in shortDateFormats([Locale l])
```

### Operation

This iterator returns the short date formats supported for the specified locale. If no locale is specified, it returns the short date formats supported for the current user locale.

The first format returned is the default short date format for the locale.

---

## for string in longDateFormats

---

### Declaration

```
for string in longDateFormats([Locale l])
```

### Operation

This iterator returns the long date formats supported for the specified locale. If no locale is specified, it returns the long date formats supported for the current user locale.

The first format returned is the default long date format for the locale.

---

## includesTime

---

### Declaration

```
bool includesTime(Date d)
```

### Operation

This returns `true` if the specified date value includes time information as well as date.

---

## dateOnly

---

### Declaration

```
Date dateOnly(Date d)
```

### Operation

Returns a copy of the supplied date value, without any included time-of-day information (it returns a date-only value).

---

## dateAndTime

---

### Declaration

```
Date dateAndTime(Date d)
```

### Operation

Returns a copy of the supplied date value including time-of-day data.

### Example

```
print today()
prints 6 June 2010
print dateAndTime(today)
prints 6/6/2010 13:42:34
```

### Example

The following example uses the new locale specific date format perms.

```
// dates.dxl - dates and formats example
//*****
void testFormat(Date dateValue, Locale loc, string format)
// DESCRIPTION: Checks that the stringOf and dateOf perms are true
//               inverses for the specified format.
```

```

{
    print "    format " format ": " stringOf(dateValue, loc, format) "\n"

} // testFormat
//*****
void testDate(Date dateValue, Locale loc)
// Tests stringOf and dateOf using default formats, and all supported formats.
{
    // Test default format
    string stringForm = stringOf(dateValue, loc)
    print "Default format: " stringForm "\n"

    // Test all supported formats
    string format
    print "Short formats:\n"
    for format in shortDateFormats(loc) do
    {
        testFormat(dateValue, loc, format)
    }
    print "Long formats:\n"
    for format in longDateFormats(loc) do
    {
        testFormat(dateValue, loc, format)
    }

    // Test abbreviations.
    print "Abbreviated names: " stringOf(dateValue, loc, "ddd, d MMM yy") "\n"
    // Test all full names.
    print "Full names: " stringOf(dateValue, loc, "dddd, d MMMM yyyy") "\n"

} // testDate
Locale loc = userLocale
print "\nLOCALE: " (name loc) "\n"
print "\nDATE ONLY:\n"

```

```
testDate(today, loc)
print "\nDATE AND TIME:\n"
testDate(dateAndTime(today), loc)
```

---

## Skip lists

This section describes DXL's features for manipulating skip lists.

Skip lists are an efficient dictionary like data structure. Since DXL does not support a C like `struct` feature, many DXL programs use skip lists as the building blocks for creating complex data structures.

Because DXL provides no garbage collection, it is important to delete skip lists that are no longer required, thereby freeing allocated memory.

Skip lists are not a fundamental type inherited from DXL's C origins, so the type name `Skip` begins with an upper case letter.

---

### create, createString(skip list)

---

#### Declaration

```
Skip create()
Skip createString()
```

#### Operation

Creates a new empty skip list and returns it.

It is very important, and it is the programmer's responsibility to ensure that data and keys are consistently used when storing and retrieving from a skip list. For example, you can cause program failure by inserting some data into a skip list as an integer, then retrieving the data into a string variable and attempting to print it.

The keys used with the skip list can be of any type. However, comparison of keys is based on the address of the key, not its contents. This is fine for elements that are always represented by a unique pointer, for example, objects, modules, or skip lists, but care is needed with strings. This is because a string may not have a unique address, depending on whether it is literal or a computed string stored in a variable.

There are two ways of avoiding this problem. The first is to use the `createString` form of the function for a skip list with a string key. The alternative is to ensure that all literal strings used as keys are concatenated with the empty string.

#### Example

```
Skip strKeys = create
put(strKeys, "literal" "", 1000)
```



---

## delete(skip list)

---

### Declaration

```
void delete(Skip s)
```

### Operation

Deletes all of skip list *s*. Variables that have been given as keys or data are not affected. This operation does not set the skip list to null. If the user checks the list for null, this will produce a DXL run-time error. The user should set the skip list to null after deletion.

---

## delete(entry)

---

### Declaration

```
bool delete(Skip s,
            type key)
```

### Operation

Deletes an entry in skip list *s* according to the passed *key*, which can be of any type. Variables that have been given as keys or data are not affected. Returns *false* if the key does not exist.

### Example

```
if (delete(numberCache, 1)) // delete absno 1
    ack "delete succeeded"
```

---

## find(entry)

---

### Declaration

```
bool find(Skip s,
          type1 key
          [,type2 &data])
```

### Operation

Returns *true* if the passed *key*, of *type1*, has an entry in skip list *s*. The optional third argument sets the entry found to be *data* of *type2*. Both *type1* and *type2* can be any type.

### Example

```
if (find(numberCache, 1, o)) {
    string h = o."Object Heading"
    ack h
}
```

---

## key

---

The `key` function is used only within the skip list `for` loop, as shown in the following syntax:

```
(type key(Skip s))
```

### Operation

Returns the key corresponding to the current element. The return value can be of any type, so a cast must precede the use of `key`.

### Example

```
Object o
for o in numberCache do {
    // must cast the key command.
    int i = (int key numberCache)
    print i
}
```

---

## put

---

### Declaration

```
bool put(Skip s,
         type1 key,
         type2 data)
```

### Operation

Returns `true` if the passed `key` and `data` are successfully inserted into the skip list `s`. Duplicate entries are not allowed, so the function returns `false` if an entry with the same `key` already exists. For this reason, an entry at an existing key must first be deleted before its data can be changed.

### Example

```
Skip s = create
put(s,1,20)
print put(s, 1, 30)
// prints 'false'
delete(s, 1)
print put(s, 1, 30)
// prints 'true', s(1) is now 30
```

---

## for data element in skip list

---

### Syntax

```
for dataElement in skiplist do {
  ...
}
```

where:

<i>dataElement</i>	is a variable of any type
<i>skiplist</i>	is a variable of type Skip

### Operation

Sets *entry* to be each successive *type* data element of *list*.

### Example

```
Object o
for o in numberCache do {
  string h = o."Object Heading"
  print h "\n"
}
```

---

## Skip lists example program

---

In this example a skip list is used to store a mapping from absolute numbers to the corresponding Rational DOORS object:

```
// skip list example
/*
  simple skip list example: make a mapping
  from absolute numbers to objects, allowing
  fast lookup
*/
Skip numberCache = create // builds the skip list
Object o
int    n = 0              // count objects

for o in current Module do {
  // cycle through all objects
  int absno = o."Absolute Number"
  // get the number
```

```

    put(numberCache, absno, o)
    // number is key, object is data
    n++
} // for
// we now have a quick way of going from absolute numbers to objects:
if (n > 0) {
    int i
    for i in 1:20 do {
        int absno = 1 + random n
        // choose an absno at random
        if (find(numberCache, absno, o)) {
            // can we find it?
            string heading = o."Object Heading"
            print "#" absno " has
                heading "\" heading "\"\n"
        } // if
    } // for
} // if

```

---

## Regular expressions

This section describes DXL's features for using regular expressions.

Regular expressions are a mechanism for detecting patterns in text. They have many applications, including searching and simple parsing.

Regular expressions are not a fundamental type inherited from DXL's C origins, so the type name `Regexp` begins with an upper case letter.

The following symbols can be used in `Regexp` expressions:

	Meaning	Example	Matches
*	zero or more occurrences	a*	any number of <b>a</b> characters, or none
+	one or more occurrences	x+	one or more <b>x</b> characters
.	any single character except new line	.*	any number of any characters (any string)
\	escape (literal text char)	\.	literally a . (dot) character

(Continued)

<code>^</code>	start of the string (if at start of <code>Regex</code> )	<code>^The.*</code>	any string starting with <b>The</b> or starting with <b>The</b> after any new line (see also <code>[]</code> below)
<code>\$</code>	end of the string (if at end of <code>Regex</code> )	<code>end\\. \$</code>	any string ending with <b>end</b> .
<code>( )</code>	Groupings	<code>(ref) +</code> <code>(bind) *</code>	at least one <b>ref</b> string then any number of <b>bind</b> strings
<code>[ ]</code>	character range (letters or digits)	<code>[sS]hall.</code> <code>*\\. \$</code>	any string containing <b>shall</b> or <b>Shall</b> and ending in a literal dot (any requirement sentence)
		<code>[^abc]</code>	any character except <b>a</b> , <b>b</b> , or <b>c</b>
		<code>[a-zA-Z]</code>	any alphabetic character
		<code>[0-9]</code>	any digit
<code> </code>	Alternative	<code>(dat doc)</code>	either the string <b>dat</b> or the string <b>doc</b>

**Note:** The regular expression escape character must itself be escaped in a DXL string. For example, to have the regular expression `\.`, you must have `\\.`  in the DXL string.

Many of the functions for regular expressions use the data type `Regex`.

---

## Application of regular expressions

---

The `space` character is an operator that applies a regular expression to a string or buffer; it is shown as `<space>` in the following syntax:

```
Regex reg <space> string text
```

```
Regex reg <space> Buffer b
```

### Operation

Returns `true` if there is a match.

### Example

```
Regex line = regex2 ".*"
while (line txt1) {
    ...
}
```

---

## match

---

The `match` function returns a range for a match of a regular expression within a string or buffer, as shown in the following syntax:

```
Regexp r = regexp "x(options1)y(options2)..."
{string|Buffer} str = "string"
str[match n]
```

where:

<code>r</code>	<code>str</code>	are variables
<code>x</code>	<code>y</code>	are literal characters in a regular expression
<code>options1</code>	<code>options2</code>	are regular expression matching options
<code>string</code>		is a string or buffer
<code>n</code>		is an integer

### Operation

When  $n=0$ , returns the range of `string`. When  $n=1$ , returns the range of the match for `options1`; when  $n=2$ , returns the match for `options2`, and so on. The value for  $n$  is restricted to the range 0-9.

### Example

This example detects and decomposes URLs:

```
Regexp URL = regexp2 "(HTTP|http|ftp|FTP|file|FILE)://([^ \\),;>\\"]*)"
string txt3 = "The ABC URL is http://www.abc.com; it may be..."
if (URL txt3) {
    print txt3[match 0] "\n" // whole match
    print txt3[match 1] "\n" // first section in ()
    print txt3[match 2] "\n" // second section in ()
}
```

---

## matches

---

### Declaration

```
bool matches(string reg,
             string text)
```

## Operation

Returns `true` if `text` matches `reg`. For repeated use, declaring and building a regular expression is more efficient.

## Example

```
string txt = "xxxxyesuuuu"
if (matches("(yes|no)", txt)) print txt[match 0]
```

## regexp

### Declaration

```
Regexp regexp(string reg)
```

### Operation

Returns a new regular expression, specified by string `reg`. For legacy support only, should not be used in new code. Replaced by `regexp2()`.

### Example

```
// matches any line except newline
Regexp line = regexp2 ".*"
```

## start, end(of match)

### Declaration

```
int start(int n)
int end(int n)
```

### Operation

Return the position of the first and last characters of the `n`th match from a call to `match`. The value for `n` is restricted to the range 0-9.

### Example

```
int firstNameLen = end 1
```

## delete(regexp)

### Declaration

```
void delete(Regexp)
```

### Operation

This perm deletes the supplied regular expression and frees the memory used by it.

---

## regexp2

---

### Declaration

```
Regexp regexp2(string expression)
```

### Operation

Creates a regular expression. Its behavior will not be changed to match the legacy behavior of `regexp()`. Should be used in all new regular expression code.

---

## Regular expressions example program

---

```
// regular expression DXL example
/*
  examples of regular expression DXL
*/

Regexp line = regexp2 ".*"
// matches any character except newline

string txt1 = "line 1\nline 2\nline 3\n"
// 3 line string

while (!null txt1 && line txt1) {
  print txt1[match 0] "\n"
  // match 0 is whole of match

  txt1 = txt1[end 0 + 2:] // move past newline
}

// The following regular expression detects and decomposes URLs
Regexp URL = regexp2 "(HTTP|http|ftp|FTP|file|FILE)://([^\ \\\,;>\""]*)"
string txt3 = "The ABC URL is http://www.abcinc.com, and may be..."

if (URL txt3) {
  print txt3[match 0] "\n" // whole match
  print txt3[match 1] "\n" // first bracketed section
  print txt3[match 2] "\n" // second.

  print start 1 // position 15 in txt3 (from 0)
  print end 1 // 18

  print start 2 // 22
  print end 2 // 34
}
```



---

## Text buffers

The following functions enable the manipulation of DXL buffers. Buffers are a speed and memory efficient way of manipulating text within DXL applications. Their use is particularly encouraged in parsers and importers.

You should explicitly delete buffers with `delete` as soon as they are no longer needed in a script.

Buffers are not a fundamental type inherited from DXL's C origins, so the type name `Buffer` begins with an upper case letter.

Because DXL provides no garbage collection, it is important to delete buffers that are no longer required, thereby freeing allocated memory.

---

### Assignment (buffer)

---

The assignment operator `=` can be used as shown in the following syntax:

```
Buffer b = string s
```

or

```
Buffer b = h.oldValue
```

#### Operation

The first form sets the contents of `buffer b` to that of the `string s`. You can use a range in the assignment.

The second form sets the contents of the `buffer` to the history property `oldValue`. The buffer should be deleted after use.

**Note:** If you want to assign a buffer to a buffer, you must use the form `Buffer b=stringOf (a)`, otherwise, the address of `a` is given to `b` instead of its value.

---

### Append operator

---

The append operator `+=` can be used as shown in the following syntax:

```
Buffer b += string s
```

```
Buffer b += char c
```

```
Buffer b += Buffer b
```

#### Operation

Appends the string, character, or buffer to the buffer `b`.

#### Example

This example prints `one1twox` in the DXL Interaction window's output pane:

```
Buffer buf1 = create
```

```
Buffer buf2 = create
```

```

buf1 = "one"
buf2 = "two"
buf1 += "1"
buf1 += buf2
buf1 += 'x'

```

---

## Concatenation (buffers)

---

The space character is the concatenation operator, which is shown as `<space>` in the following syntax:

```
Buffer b <space> string s
```

Concatenates string *s* onto the contents of buffer *b* and returns the result as a string. You can use a range in the concatenation.

### Example

```

Buffer b = create
b = "aaa"
print b "zzz"           // prints "aaazzz"

```

---

## Buffer comparison

---

String relational operators can be used as shown in the following syntax:

```

Buffer b1 == Buffer b2
Buffer b1 != Buffer b2
Buffer b1 < Buffer b2
Buffer b1 > Buffer b2
Buffer b1 <= Buffer b2
Buffer b1 >= Buffer b2

```

These operators return `true` if *b1* is equal, not equal, less than, greater than, less than or equal to, or greater than or equal to *b2*. Case is significant.

### Example

```

Buffer b1 = create
Buffer b2 = create
b1 = "aaa"
b2 = "aza"
print (b1==b2) " " (b1!=b2) " " (b1b2) " "
print (b1b2) " " (b1<=b2) " " (b1>=b2) "\n"

```

```
// prints "false true true false true false"
```

---

## Read and write operators

---

The `>>` operator can be used to read a stream into a buffer and return the stream (see “Read from stream,” on page 134).

The `<<` operator can be used to write a buffer to a stream and return the stream (see “Read line from stream,” on page 134).

The `->` and `>=` operators can be used to read a single line from a file to a buffer, (see “Write to stream,” on page 135).

---

## Character extraction from buffer

---

The index notation, `[ ]`, can be used to extract a single character from a buffer, as shown in the following syntax:

```
Buffer b[int n]
```

This returns the  $n^{\text{th}}$  character of buffer *b*, counting from 0.

### Example

This example prints `a` in the DXL Interaction window’s output pane:

```
Buffer b = "abc"
char c = b[0]
print c
```

---

## Substring extraction from buffer

---

The index notation, `[ ]`, can be used to extract a substring from a buffer, as shown in the following syntax:

```
Buffer b[range]
```

### Operation

Returns a range of *b* as specified by *range*, which must be in the form `int:int`.

The *range* argument is specified as the indices of the first and last characters of the desired range, counting from 0. If the range continues to the end of the buffer, the second index can be omitted. This function returns a buffer or string depending on the type assigned.

### Example

```
Buffer buf = create
buf = "abcdefg"
string s = buf[2:3]
print s                // prints cd
Buffer b = buf[4:5]
print b                // prints ef
```

---

## combine

---

### Declaration

```
void combine(Buffer b1,
            Buffer b2,
            int start
            [,int finish])
```

### Operation

Concatenates a substring of *b2* onto the contents of *b1*. The substring is from *start* to *finish*, or if *finish* is omitted, from *start* to the end of the buffer. This function provides a performance advantage over the assignment to buffer using the range option.

### Example

```
Buffer b1 = create, b2 = create
b1 = "zzz"
b2 = "abcdef"
combine(b1, b2, 3, 4)
print stringOf b1      // prints "zzzde"
```

---

## contains

---

### Declaration

```
int contains(Buffer b,
            char ch
            [,int offset])

int contains(Buffer b,
            string word,
            int offset)
```

### Operation

The first form returns the index at which the character *ch* appears in buffer *b*, starting from 0. If present, the value of *offset* controls where the search starts. For example, if *offset* is 1, the search starts from 2. If *offset* is not present, the search starts from 0. If *ch* does not appear after *offset*, the function returns -1.

The second form returns the index at which string *word* appears in the buffer, starting from 0, provided the string is preceded by a non-alphanumeric character. The value of the mandatory *offset* argument controls where the search starts. If *word* does not appear after *offset*, the function returns -1.

---

## getDOSstring

---

### Declaration

```
Buffer getDOSstring(Buffer b)
```

### Operation

Returns a copy of the supplied Buffer, with a carriage-return character inserted before any newline character that is not already preceded by a carriage return.

---

## create(buffer)

---

### Declaration

```
Buffer create([int initSize])
```

### Operation

Creates a buffer. A buffer has no intrinsic limit on its size; when a buffer becomes full it extends itself, if memory permits. The argument *initSize* specifies the initial size of the buffer. If no initial size argument is passed, this function creates a buffer that uses a default initial size of 255.

---

## delete(buffer)

---

### Declaration

```
void delete(Buffer &b)
```

### Operation

Deletes the buffer *b*, and sets the variable *b* to null.

---

## firstNonSpace

---

### Declaration

```
int firstNonSpace(Buffer b)
```

### Operation

Returns the index of the first non-space character in buffer *b*, or -1 if there is none.

---

## keyword(buffer)

---

### Declaration

```
int keyword(Buffer b,  
            string word,  
            int offset)
```

### Operation

Returns the index at which string *word* appears in buffer *b*, starting from character *offset*, provided that the string is neither preceded nor followed by a non-alphanumeric character. If *word* does not appear, the function returns  $-1$ .

This function is used to accelerate parsing of programming languages.

---

## length(buffer get)

---

### Declaration

```
int length(Buffer b)
```

### Operation

Returns the length of the buffer.

---

## length(buffer set)

---

### Declaration

```
void length(Buffer b,  
            int len)
```

### Operation

Sets the length of a buffer. This is normally used for truncating buffers, but can also be used to lengthen them.

The DXL program is responsible for the content of the buffer.

### Example

```
Buffer buf = create  
buf = "abcd"  
length(buf, 2)  
print "<" (stringOf buf) ">" // prints "ab"
```

---

## set(char in buffer)

---

### Declaration

```
void set(Buffer b,  
        int n,  
        char ch)
```

### Operation

Sets the character at position *n* of buffer *b* to character *ch*.

### Example

```
if (name[n] == '.') set (name, n, ';')
```

---

## setempty

---

### Declaration

```
void setempty(Buffer b)
```

### Operation

Empties buffer *b*, but does not reclaim any space.

---

## setupper, setlower

---

### Declaration

```
void setupper(Buffer b)
```

```
void setlower(Buffer b)
```

### Operation

These functions convert the case of buffer *b* to upper or lower case.

---

## stringOf(buffer)

---

### Declaration

```
string stringOf(Buffer b)
```

### Operation

Returns the contents of buffer *b* as a string.

### Example

```
Buffer b = create
```

```
b = "aaaa"
print stringOf b      // prints "aaaa"
```

---

## Buffers and regular expressions

---

Regular expressions can be applied to buffers in the same way as strings (see “Application of regular expressions,” on page 159). The regular expression functions `start`, `end` (of `match`), and `match` can also be used with buffers.

### Example

```
Buffer buf = create
buf = "aaaabbccccc"
Regexp re = regexp2 "a*"
re buf      // apply regular expression
print buf[match 0] // prints "aaaa"
```

---

## search

---

### Declaration

```
bool search(Regexp re,
            Buffer b,
            int start
            [,int finish])
```

### Operation

Searches part of *b* using *re*. The search starts at *start* and continues until *finish*, or if *finish* is omitted, from *start* to the end of the buffer.

This function provides a performance advantage over the concatenation of regular expression to buffer with the range option.

Note that the `match`, `end` and `start` regular expression functions can be used to return offsets relative to *start*, not the start of the buffer.

It is possible when using this perm along with a complex regular expression, and a very large Buffer, that valid code will produce a run-time error detailing an “incorrect regular expression”.

---

## Text buffers example program

---

```
// buffer DXL example
/*
example use of DXL buffers - place a border
around a multi-line piece of text, e.g.:
+-----+
| the quick brown |
```



```

| fox jumped over |
| the lazy dog    |
+-----+
*/
Buffer process(Buffer source) {
    Regexp line = regexp2 ".*"      // matches up to newline
    int from = 0
    int max = 0
    Buffer boxed = create, horiz = create
    while (search(line, source, from)) {
        // takes a line at a time from source
        int offset = end 0
        // end of the match within source
        string match = source[from:from+offset]
        from += offset + 2
        // move 'from' over any newline
        if (null match)          // we are done
            break
        max = max >? length match
        // remember max line length
    }
    if (max==0) { // no strings matched
        boxed = "++\n++"
    } else {
        horiz = "+"      // build a horizontal line
        int i
        for i in 1:max+2 do // allow two spaces
            horiz += '-'
        horiz += '+'
        horiz += '\n'
        from = 0          // reset offset
        boxed += horiz
        while (search(line, source, from)) {
            // rescan buffer
            int offset = end 0
            string match =
                source[from:from+offset]
            if (null match)
                break
            from += offset + 2

```

```

        boxed += '|' // add the vertical bars
        boxed += ' '
        boxed += match
        for i in 1 : max - length match + 1 do
            boxed += ' '
            // add space to side of box
        boxed += '|'
        boxed += '\n'
    }
    boxed += horiz
    return boxed
}
}
Buffer text = create
text = "The quick brown" // build a test string
text += '\n'
text += "fox jumped over"
text += '\n'
text += "the lazy dog"
cout = write "buffer.tmp"
cout << process text // print result

```

---

## Arrays

This section describes a dynamically sized two-dimensional array data type. An example of its use is in the Rational DOORS ASCII output generator in the tools library. As with skip lists, you must retrieve data into variables of the same data type as they were put into the array, or program failure may occur.

Because DXL provides no garbage collection, it is important to delete DXL's dynamic arrays that are no longer required, thereby freeing allocated memory.

Dynamic arrays are not a fundamental type inherited from DXL's C origins, so the type name `Array` begins with an upper case letter.

---

### create(array)

---

#### Declaration

```

Array create(int x,
            int y)

```

## Operation

Creates a dynamically sized array of initial bounds  $(x,y)$ . Following C conventions, the minimum co-ordinate is  $(0,0)$ , and the maximum co-ordinate is  $(x-1,y-1)$ . If an assignment is made to an array element outside these initial bounds, the array is automatically resized. When viewing arrays with the `printCharArray` function, the X axis grows left to right across the page, while the Y axis grows down the page.

Both arguments to create must be greater than or equal to 1.

## Example

This example creates an array with 50 elements in the X direction accessed from  $(0,0)$  to  $(49,0)$ , and only one element in the Y direction:

```
Array firstArray = create(50,1)
```

## delete(array)

### Declaration

```
void delete(Array a)
```

### Operation

Deletes array `a`; stored contents are not affected.

## get(data from array)

### Declaration

```
type get(Array a,
         int x,
         int y)
```

### Operation

Returns the data, of any type, stored in array `a` at position  $(x, y)$ . You must retrieve the data into a variable of the same type as used when the data was put into the array. To ensure that this works unambiguously in the way intended, you should use a cast prefix to the `get` command.

Arrays are not just for fundamental types like strings and integers. You can store any DXL type in them, for example, objects, modules, skip lists, and even other arrays.

### Example

This example uses a cast prefix to `get`:

```
Array a = create(10,10)
string str
int i
put(a, "a string", 3, 4)
put(a, 1000, 3, 5)
```

```

str = (string get(a,3,4)) // cast get as string
print str "\n"           // prints "a string"
i = (int get(a, 3, 5))   // cast get as int
print i                  // prints "1000"

```

This example stores an array in an array:

```

Array a = create(4,1)
Object obj = first current Module
Module mod = current
Skip skp = create
Array arr = create(1,1)
put(a, obj, 0, 0)
put(a, mod, 1, 0)
put(a, skp, 2, 0)
put(a, arr, 3, 0)
put(arr,"I was nested in a!", 0, 0)
Object objRef = (Object get(a,0,0))
Module modRef = (Module get(a,1,0))
Skip skpRef = (Skip get(a,2,0))
Array arrRef = (Array get(a,3,0))
string str = (string get(arrRef, 0, 0))
print str // prints "I was nested in a!"

```

---

## get(string from array)

---

### Declaration

```

string get(Array a,
           int x,
           int y,
           int len)

```

### Operation

Retrieves *len* characters as a string from *a* starting at position (*x,y*). This is the matching `get` command for `putString`.

### Example

```

Array a = create(10,10)
putString(a, "a string", 2, 2)
string some = get(a, 4, 2, 3)

```

```
print some "\n"           // prints "str"
```

## put(data in array)

### Declaration

```
void put(Array a,
         type data,
         int x,
         int y)
```

### Operation

Puts *data*, of any type, into array *a* at position (*x*,*y*). If the new position is outside *a*'s current bounds, *a* is resized to accommodate the new element.

## putString

### Declaration

```
void putString(Array a,
              string s,
              int x,
              int y)
```

### Operation

Puts the string *s* into the array *a* in such a way that its character contents are placed in X-direction adjacent elements starting at (*x*,*y*). The original, or any other desired string can be rebuilt by using the argument string form of `get (a, x, y, len)`. The 3-argument form of `get` can be used to retrieve individual characters. Attempting to retrieve a character as a string causes program failure.

## printCharArray

### Declaration

```
void printCharArray(Array a,
                  Stream s,
                  int x1,
                  int y1,
                  int x2,
                  int y2)
```

### Operation

Sends the section of array *a* defined by the passed co-ordinates *x1*,*y1* and *x2*,*y2*, to the stream *s*.

### Example

```
Array a = create(20,5)
```

```
int x,y
for y in 0 : 4 do      // populate an array with a
  for x in 0 : 19 do  // block of # characters.
    put(a, '#', x, y)
Stream out = write "array.tmp" // open a stream
printCharArray(a, out, 0, 0, 19, 4) // write original block
out << "\n"
putString(a,"abc", 3, 1) // insert a string
printCharArray(a, out, 0, 0, 19, 4)
// view change
out << "\n"
close out
```

## Chapter 12

# Operating system interface

This chapter describes three major packages of functions that allow Rational DOORS to communicate with the host operating system:

- Operating system commands
- Windows registry
- Interprocess communications
- System clipboard functions

---

## Operating system commands

This section defines functions that interact with the operating system under which Rational DOORS is being run. For a DXL program to be portable between platforms, care is needed when using these facilities. The functions that use the `Stat` data type work on the `stat` API provided by the operating system, which enables DXL programs to determine the status of files and directories.

---

### platform

---

#### Declaration

```
string platform()
```

#### Operation

Returns the name of the current Rational DOORS platform, currently one of:

<b>Linux</b> <sup>®</sup>	Linux
<b>Solaris</b>	Sun
<b>WIN32</b>	All Windows platforms

This function can be used to make programs portable between platforms.

#### Example

```
string fileGoodName_(string root, extpc, extunix) {
    if (platform == "WIN32")
        return currentDirectory "\\\"
            goodFileName root extpc
```

```

else
    return (getenv "HOME") "/"
        goodFileName root extunix
}

```

The function `fileGoodName_`, defined in `$DOORSHOME/lib/dxl/utils/ fileops.dxl` uses `platform` to construct an appropriate file name for the current operating system. Using such functions enables DXL programs to be useful on all platforms. Literal file names in programs may not be portable. The path `/tmp/dxl/myfile` may work on a WIN32 platform, but `c:\temp\dxl\myfile` cannot work on a UNIX platform.

## getMemoryUsage

### Declaration

```
int getMemoryUsage()
```

### Operation

Returns the Rational DOORS client memory usage in MB.

## getenv

### Declaration

```
string getenv(string var)
```

### Operation

Returns the current value of the environment variable `var`, as set in the operating system. Both Windows and UNIX platforms support this mechanism.

**Note:** You should know about your operating system's environment variables before using this function. If necessary, consult the operating system documentation.

### Example

```

print getenv("HOME")
print getenv("DATA")
print getenv("DOORSHOME")
print getenv("DOORSDATA")

```

The first two examples return the corresponding variable values in the registry.

The second two examples return the corresponding variable values used in a command-line shortcut to start Rational DOORS, if set. Otherwise, returns the values set in the registry.



---

## hostname

---

### Declaration

```
string hostname()
```

### Operation

Returns a string, which is the name of the current host system.

---

## fullHostname

---

### Declaration

```
string fullHostname(void)
```

### Operation

Gets the fully qualified hostname of the machine on which the perm is executed.

---

## mkdir

---

### Declaration

```
void mkdir(string dirName  
           [,string osParm])
```

### Operation

Creates directory *dirName*.

Optional argument *osParm* can contain information that is dependent on the operating system, such as the UNIX octal file access mask.

### Example

The following example creates a typical UNIX path name, and sets the access rights:

```
mkdir("/usr/development/phase1", "0755")
```

The following example creates a Windows path, for which there are no access rights:

```
mkdir("C:\\DOORS\\DXLEExample\\", "")
```

---

## setenv

---

### Declaration

```
void setenv(string var,  
            string s)
```

## Operation

Sets the registry variable *var* to *s* in the registry section

HKEY\_CURRENT\_USER\Software\Telelogic\DOORS\*<DOORS version>*\Config, where *<DOORS version>* is the version number of the current version of Rational DOORS installed.

Before using this function, you should be familiar with your operating system's registry variables. If necessary, consult your operating system documentation.

## setServerMonitor

### Declaration

```
void setServerMonitor(bool on)
```

### Operation

On Windows platforms only, when *on* is `true`, activates the Rational DOORS Server Monitor. This inserts an icon in the Windows task bar that monitors client server communications.

## serverMonitorIsOn

### Declaration

```
bool serverMonitorIsOn()
```

### Operation

On Windows platforms only, returns `true` if the Rational DOORS Server Monitor is active. Otherwise, returns `false`.

## username

### Declaration

```
string username()
```

### Operation

Returns a string that contains the operating system defined user name under which Rational DOORS is being run. This may not be the same as the Rational DOORS user name returned by `doorsname`, depending on the current project's setup.

## system

### Declaration

```
void system(string command)
```

## Operation

On Windows platforms only, passes the string *command* to the operating system for execution, and continues the current DXL program. Using *platform* in conjunction with this function prevents an error message on UNIX platforms.

## Example

```
if (platform=="WIN32")
    system "notepad"
```

Note that if the command to be executed is a built in DOS command, such as `del`, you need, for example:

```
system "c:\\windows\\command.exe /c del temp.txt"
```

## Declaration

```
void system(string command,
            void childCB(int)
            [,void parentCB()])
```

## Operation

On UNIX platforms only, passes the string *command* to the operating system for execution.

Unlike the Windows `system` function, these functions terminate the current execution path of the calling DXL program. One or two callback functions must be provided. In the first form, only a function *childCB* is needed. This function is called when the operating system finishes execution of *command*. In the second form, *parentCB* is also provided; this is called concurrently with the operating system's processing of *command*, enabling the calling DXL program to continue work while the command is being executed.

## Example

```
void cb(){
    print "system command executing\n"
}

void nullCB(int status){
}

if (platform == "WIN 32"){
    system("E:\\winnt\\system32\\command.exe")
        cb
} else{
    system ("xterm", nullCB, cb)
}
```

## create(status handle)

### Declaration

```
Stat create(Stream s)
Stat create(string filename)
```

## Operation

Returns a status handle for the stream or file name, which is used in the other `Stat` functions.

### `delete(status handle)`

#### Declaration

```
void delete(Stat s)
```

#### Operation

Deletes the handle `s`.

### `accessed, modified, changed(date)`

#### Declaration

```
Date accessed(Stat s)
```

```
Date modified(Stat s)
```

```
Date changed(Stat s)
```

#### Operation

Returns the accessed, modified or changed date of the stream or file identified by the handle.

### `directory, symbolic, regular`

#### Declaration

```
bool directory(Stat s)
```

```
bool symbolic(Stat s)
```

```
bool regular(Stat s)
```

#### Operation

Returns `true` if the stream or file identified by the handle is a directory, a symbolic link, or a regular file respectively.

#### Example

```
Stat s
string filename = "/etc"
s = create filename
if (!null s && directory s)
    ack filename " is a directory!"
```

---

## user, size, mode

---

### Declaration

```
string user(Stat s)
int size(Stat s)
int mode(Stat s)
```

### Operation

Returns the user name (PC file on windows), size, or mode of the stream or file identified by the handle.

The following constant integers are used with the `int mode(Stat)` function as bit-field values (using standard UNIX `stat` semantics).

Constant	Meaning
<code>S_ISUID</code>	set user id on execution
<code>S_ISGID</code>	set group id on execution
<code>S_IRWXU</code>	read, write, execute permission: owner
<code>S_IRUSR</code>	read permission: owner
<code>S_IWUSR</code>	write permission: owner
<code>S_IXUSR</code>	execute/search permission: owner
<code>S_IRWXG</code>	read, write, execute permission: group
<code>S_IRGRP</code>	read permission: group
<code>S_IWGRP</code>	write permission: group
<code>S_IXGRP</code>	execute/search permission: group
<code>S_IRWXO</code>	read, write, execute permission: other
<code>S_IROTH</code>	read permission: other
<code>S_IWOTH</code>	write permission: other
<code>S_IXOTH</code>	execute/search

### Example

The following example shows how to emulate the formatting of part of the UNIX command `ls -l`.

```
string filename = "/etc"
Stat s = create filename
```

```

if (!null s) {
    int modes = mode s
    print (modes&S_ISUID!=0 ? 's' : '-')
    print (modes&S_IRUSR!=0 ? 'r' : '-')
    print (modes&S_IWUSR!=0 ? 'w' : '-')
    print (modes&S_IXUSR!=0 ? 'x' : '-')
    print (modes&S_IRGRP!=0 ? 'r' : '-')
    print (modes&S_IWGRP!=0 ? 'w' : '-')
    print (modes&S_IXGRP!=0 ? 'x' : '-')
    print (modes&S_IROTH!=0 ? 'r' : '-')
    print (modes&S_IWOTH!=0 ? 'w' : '-')
    print (modes&S_IXOTH!=0 ? 'x' : '-')
    print "\t" filename
}

```

---

## Status handle functions example

---

This example is taken from `$DOORSHOME/lib/dxl/utils/fileops.dxl`.

```

bool fileExists_(string filename) {
    Stat s
    s = create filename
    if (null s) return false
    delete s
    return true
}

```

It is used by several of the DXL Library tools to determine whether a file exists.

---

## Windows registry

---

### getRegistry

---

#### Declaration

```

string getRegistry(string keyName,
                  string valueName)

```

## Operation

Returns a string representation of the named value of the specified Windows registry key.

The *keyName* argument must be a fully specified registry key, beginning with any one of the following:

HKEY\_CURRENT\_USER

HKEY\_LOCAL\_MACHINE

HKEY\_CLASSES\_ROOT

HKEY\_USERS

If *valueName* is null, returns the default value for the key. If the key does not exist, the value does not exist, or the operating system is not a Windows platform, returns *null*.

## Example

```
string s = "HKEY_CURRENT_USER\\SOFTWARE\\Microsoft
Office\\9.3\\Common\\LocalTemplates"
print getRegistry(s, null) "\n"
string s = "HKEY_CURRENT_USER\\SOFTWARE\\Microsoft Office\\95\\WORD\\OPTIONS"
print getRegistry(s, "DOC-PATH") "\n"
```

---

## setRegistry

---

### Declaration

```
string setRegistry(string keyName,
                  string valueName,
                  {string|int} value)
```

### Operation

Sets the named value of the specified registry key to have the value supplied and the appropriate registry type, as follows:

Type of value	Registry type
string value	REG_SZ
integer value	REG_DWORD

The key is created if one does not already exist. If *valueName* is null, the default key value is set.

The *keyName* argument must be a fully specified registry key, beginning with any one of the following:

HKEY\_CURRENT\_USER

HKEY\_LOCAL\_MACHINE

HKEY\_CLASSES\_ROOT

HKEY\_USERS

This function is only usable on Windows platforms.

If the operation fails, returns an error message; otherwise returns null.

### Example

```
string s = "HKEY_CURRENT_USER\\SOFTWARE\\XYZ Inc.\\The Product\\Verification"
// Set default value of key
string errMsg = setRegistry(s, null, "Default string value")
// Set named string value
errMsg = setRegistry(s, "Configuration Parameter", "Is enabled")
// Set named integer value
checkStringReturn setRegistry(s, "Usage count", 1234)
```

## deleteKeyRegistry

### Declaration

```
string deleteKeyRegistry(string keyName)
```

### Operation

Deletes the named key from the registry, therefore extreme caution should be used.

The *keyName* argument must be a fully specified registry key, beginning with any one of the following:

```
HKEY_CURRENT_USER
HKEY_LOCAL_MACHINE
HKEY_CLASSES_ROOT
HKEY_USERS
```

This function is only usable on Windows platforms.

If the operation fails, returns an error message; otherwise returns null.

### Example

```
// Clear up keys created
string errMsg = deleteKeyRegistry "HKEY_CURRENT_USER\\-
    SOFTWARE\\XYZ Inc.\\The Product\\Verification"
errMsg = deleteKeyRegistry "HKEY_CURRENT_USER\\SOFTWARE\\XYZ Inc.\\The
Product"
errMsg = deleteKeyRegistry "HKEY_CURRENT_USER\\SOFTWARE\\XYZ Inc."
```



---

## deleteValueRegistry

---

### Declaration

```
string deleteValueRegistry(string keyName,  
                           string valueName)
```

### Operation

Deletes the named value from the specified registry key. If *valueName* is null, deletes the default value for the key.

**Note:** Use caution when calling this function.

The *keyName* argument must be a fully specified registry key, beginning with any one of the following:

HKEY\_CURRENT\_USER

HKEY\_LOCAL\_MACHINE

HKEY\_CLASSES\_ROOT

HKEY\_USERS

This function is only usable on Windows platforms.

If the operation fails, returns an error message; otherwise returns null.

### Example

```
string s = "HKEY_CURRENT_USER\\SOFTWARE\\XYZ Inc.\\-  
          The Product\\Verification"  
  
// Delete named value  
string errMess = deleteValueRegistry(s, "Usage count")  
  
// Delete default value  
errMess = deleteValueRegistry(s, null)
```

---

## Interprocess communications

There are two forms of interprocess communications (IPC):

- The first uses TCP/IP. It can be used with the UNIX and Windows operating systems on all supported platforms.
- The second uses sockets, where a file is used to pass messages. It works only on UNIX platforms.

For examples of how to use DXL IPC functions, see the Rational DOORS API Manual.

Windows programs can also use OLE Automation functions to communicate with other programs.

---

## ipcHostname

---

### Declaration

```
string ipcHostname(string ipAddress)
```

### Operation

Resolves the IP address *ipAddress* to its host name.

### Example

This example prints `localhost` in the DXL Interaction window's output pane.

```
print ipcHostname("127.0.0.1")
```

---

## server

---

### Declaration

```
IPC server(string socket)
```

```
IPC server(int port)
```

### Operation

The first form establishes a server connection to the UNIX socket *socket*.

The second form establishes a server connection to the port number *port* on **all** platforms. In the case that supplied port number is 0, an ephemeral port number is allocated by the operating system. To fetch this ephemeral port number, use `getPort()` on the resulting IPC.

---

## getPort

---

### Declaration

```
int getPort(IPC channel)
```

### Operation

Fetches the port associated with the specified IPC. Useful when the IPC is allocated an ephemeral port by the operating system (see `IPC server(int)`).

---

## client

---

### Declaration

```
IPC client(string socket)
```

```
IPC client(int ip,  
           string host)
```

## Operation

The first form establishes a client connection to the UNIX socket *socket*.

The second form establishes a client connection to the IP address *ip* at *host* on **all** platforms.

## accept

### Declaration

```
bool accept(IPC)
```

### Operation

Waits for a client connection at the server end of the connection.

## send

### Declaration

```
bool send(IPC chan,
          string message)
```

### Operation

Sends the string *message* down IPC channel *chan*.

## recv

### Declaration

```
bool recv(IPC chan,
          {string|Buffer} &response
          [,int tmt])
```

### Operation

Waits for a message to arrive in channel *chan* and assigns it to string or buffer variable *response*.

The optional third argument defines a timeout, *tmt* seconds, for a message to arrive in channel *chan*. If *tmt* is zero, these functions wait forever. They only work if the caller is connected to the channel as a client or a server.

## disconnect

### Declaration

```
void disconnect(IPC chan)
```

### Operation

Disconnects channel *chan*.

---

## delete(IPC channel)

---

### Declaration

```
void delete(IPC chan)
```

### Operation

Deletes channel *chan* (can be a server or a client).

---

## System clipboard functions

---

### copyToClipboard

---

#### Declaration

```
bool copyToClipboard(string s)
```

#### Operation

Copies a plain text string (not RTF) to the clipboard. On success, returns `true`.

---

### setRichClip

---

#### Declaration

```
void setRichClip(RTF_string__ s, string styleName, string fontTable)
void setRichClip(Buffer buff, string styleName, string fontTable)
void setRichClip(RTF_string__ s, string styleName, string fontTable, bool
keepBullets, bool keepIndents)
void setRichClip(Buffer buff, string styleName, string fontTable, bool
keepBullets, bool keepIndents)
```

#### Operation

First form sets the system clipboard with the rich text obtained by applying the style *styleName* to the string *s*, using the font table *fontTable* supplied, which should include a default font. Font numbers in the string *s* will be translated to the supplied font table *fontTable*.

Second form is same as the first but the source is a buffer *buff* rather than an *RTF\_string\_\_*.

Third form sets the system clipboard with the rich text obtained by applying the style *styleName* to the string *s*, using the font table *fontTable* supplied. If *keepBullets* is `false`, any bullet characters are removed from string *s*. If *keepIndents* is `false`, any indentation is removed from string *s*. If *keepBullets* and *keepIndents* are both `true`, the behavior is exactly the same as the first form.

Fourth form is same as the third but the source is a buffer *buff* rather than an *RTF\_string*.

## Example 1

The following code:

```
string s = "hello"
string fontTable = "\\deff0{\\fonttbl {\\f1 Times New Roman;}}"
setRichClip(richText s, "Normal", fontTable)
puts the following rich text string onto the system clipboard:
{\rtf1 \deff0{\\fonttbl {\\f1 Times New Roman;}}{\\stylesheet {\\s1 Normal;}}{\\s1
hello\\par}}
```

## Example 2

```
string bulletedString =
"{\\rtf1\\ansi\\ansicpg1252\\deff0\\deflang1033{\\fonttbl{\\f0\\fswiss\\fcharset0
Arial;}{\\f1\\fnil\\fcharset2 Symbol;}}
\\viewkind4\\uc1\\pard\\f0\\fs20 Some text with\\par
\\pard{\\pntext\\f1\\'B7\\tab}{\\*\\pn\\pnlvblt\\pnf1\\pnindent0{\\pntxtb\\'B7
}}\\fi-720\\li720 bullet 1\\par
{\\pntext\\f1\\'B7\\tab}bullet 2\\par
\\pard bullet points in it.\\par
\\par
}"

string fontTable = "\\deff0{\\fonttbl{\\f0\\fswiss\\fcharset0
Arial;}{\\f1\\fnil\\fcharset2 Symbol;}}"

setRichClip(richText bulletedString, "Normal", fontTable)

// the previous call puts
// "{\\rtf1 \deff0{\\fonttbl{\\f0\\fswiss\\fcharset0 Arial;}{\\f1\\fnil\\fcharset2
Symbol;}}{\\stylesheet {\\s1 Normal;}}{\\s1 Some text with\\par {\\f1\\b7\\tab}bullet
1\\par {\\f1\\b7\\tab}bullet 2\\par bullet points in it.\\par \\par}}}"
// on the clipboard

setRichClip(richText bulletedString, "Normal", fontTable, false, false)

// the previous call puts
```

```
// "{\rtf1 \deff0{\fonttbl{\f0\fswiss\fcharset0 Arial;}{\f1\fnil\fcharset2  
Symbol;}}{\stylesheet {\s1 Normal;}}{\s1 Some text with\par bullet 1\par bullet  
2\par bullet points in it.\par \par}}"  
  
// on the clipboard -- note no bullet symbols (\'b7) in the markup
```

## Chapter 13

# Customizing Rational DOORS

This chapter explains how you can customize Rational DOORS:

- Color schemes
- Database Explorer options
- Locales
- Codepages
- Message of the day
- Database Properties

---

## Color schemes

This section defines constants and functions for setting the Rational DOORS color scheme.

---

### Display Color Schemes

---

The following constants are defined as database display schemes for use with the functions below:

`originalDOORSColorScheme`

`modernDOORSColorScheme`

`highContrastOneColorScheme`

`highContrastTwoColorScheme`

`highContrastBlackColorScheme`

`highContrastWhiteColorScheme`

---

### getDefaultColorScheme

---

#### Declaration

```
int getDefaultColorScheme()
```

#### Operation

Returns the default color scheme used by the Database Explorer. The possible values for `colorScheme` are listed above.

---

## setDefaultColorScheme

---

### Declaration

```
void setDefaultColorScheme(int colorScheme)
```

### Operation

Sets the default color scheme used by the Database Explorer. Schemes can be created and modified using the **Display** tab in the Options dialog box (from the **Tools > Options** menu in the Database Explorer). The possible values for `colorScheme` are listed above:

---

## optionsExist

---

### Declaration

```
bool optionsExist(string schemeName)
```

### Operation

Returns `true` if a color scheme exists under `schemeName`; otherwise, returns `false`.

---

## resetColors

---

### Declaration

```
void resetColors([int colorScheme])
```

### Operation

If no argument is supplied, resets to the default color scheme otherwise resets to `colorScheme`, which can any of the values listed above.

---

## resetColor

---

### Declaration

```
void resetColor(int colorIndex  
                [,int colorScheme])
```

### Operation

Resets the color specified by `colorIndex` to the default, or if the second argument is supplied, to `colorScheme`, which can be any of the values listed above.



---

## Database Explorer options

This section defines constants and functions for customizing the Database Explorer.

---

### Font constants

---

#### Declaration

```
int HeadingsFont
int TextFont
int GraphicsFont
```

#### Operation

These constants define the font in the `getFontSettings` and `setFontSettings` functions.

---

### getFontSettings

---

#### Declaration

```
void getFontSettings(int level,
                    int usedIn,
                    int &size,
                    int &family,
                    bool &bold,
                    bool &italic)
```

#### Operation

Passes back settings for the font *usedIn* for objects at heading level *level*. The value of *usedIn* can be `HeadingsFont`, `TextFont`, or `GraphicsFont`. The last four arguments pass back the point size, font family, whether the font is bold, and whether the font is italic. The constants for point size are the following:

- 14pt = 5
- 12pt = 4
- 11pt = 3
- 10pt = 2
- 9pt = 1
- 8pt = 0

---

## setFontSettings

---

### Declaration

```
void setFontSettings(int level,
                    int usedIn,
                    int size,
                    int family,
                    bool bold,
                    bool italic)
```

### Operation

Sets the point size, font family, whether the font is bold, and whether the font is italic for the font *usedIn* for objects at heading level *level*. The value of *usedIn* can be `HeadingsFont`, `TextFont`, or `GraphicsFont`. The constants for point size are the following:

- 14pt = 5
- 12pt = 4
- 11pt = 3
- 10pt = 2
- 9pt = 1
- 8pt = 0

---

## refreshExplorer

---

### Declaration

```
void refreshExplorer(Module m)
```

### Operation

Refreshes the Database Explorer window for module *m*.

---

## synchExplorer

---

### Declaration

```
void synchExplorer(Module m)
```

### Operation

Refreshes the Rational DOORS Module Explorer window to reflect changes to the current object selected in the module display.

---

## refreshDBExplorer

---

### Declaration

```
void refreshDBExplorer()
```

### Operation

Refreshes the Database Explorer window to reflect changes to the current folder or the display state. If the current folder/project is changed using DXL, this perm will not change the currently open item to reflect this. This is used to only refresh the contents of the currently selected item.

---

## setShowFormalModules, setShowDescriptiveModules, setShowLinkModules

---

### Declaration

```
void setShowFormalModules(bool expression)
void setShowDescriptiveModules(bool expression)
void setShowLinkModules(bool expression)
```

### Operation

Shows formal, descriptive, or link modules in the Database Explorer if *expression* is true. Hides formal, descriptive, or link modules if *expression* is false.

---

## showFormalModules, showDescriptiveModules, showLinkModules(get)

---

### Declaration

```
bool showFormalModules()
bool showDescriptiveModules()
bool showLinkModules()
```

### Operation

Returns true if the Database Explorer is set to show formal, descriptive, or link modules; otherwise returns false.

---

## getSelectedItem

---

### Declaration

```
Item getItemSelected()
```

### Operation

Return the item currently selected in the Database Explorer.

---

## Mini database explorer

---

### fnMiniExplorer

---

Creates a miniature database explorer window that shows a tree view in which you can navigate through the hierarchy of the Rational DOORS database and select an item. The layout of the tree view depends on whether your main client window is configured for Project View or Database View. The items that are displayed can be controlled through the use of a filter.

By default, only projects and folders are populated. You must explicitly choose module types. For ease of use, it is possible to have the tree view expand to a particular start location. The dialog box is modal and therefore prevents other use of the Rational DOORS client while it is displayed.

#### Declaration

```
string fnMiniExplorer([Folder f | DB parent,] int itemFilter, string titleBar,
string userPrompt)
```

#### Operation

Returns the name of the module if found otherwise returns an empty string.

Optional parameter *f* specifies the folder where the tree-view will auto-expand.

Optional parameter *parent* specifies the parent DXL dialog.

Parameter *titleBar* specifies the title window. If no value is specified (i.e. null or empty string) then "DOORS Database Mini-Explorer" will be shown.

Parameter *userPrompt* specifies the user prompt. If no value is specified (i.e. null or empty string) then "Please make your selection..." will be shown.

Parameter *itemFilter* specifies what module types are shown in the tree-view. This is a bit mask that can have the following values:

Value	Use this flag to include...
MINI_EXP_LINK_MODS	Link modules
MINI_EXP_FORMAL_MODS	Formal modules
MINI_EXP_DESCRIPTIVE_MODS	Descriptive modules

Value	Use this flag to include...
MINI_EXP_SHOW_DELETED	Soft-deleted modules
MINI_EXP_SHOW_ALL_NO_DELETED	All module types
MINI_EXP_SHOW_ALL	All module types and soft-deleted modules

### Example

```
string moduleName = fnMiniExplorer(folder("/My Project/My Folder"),
MINI_EXP_FORMAL_MODS | MINI_EXP_LINK_MODS, "Browse", "Select a source module")
```

---

## Locales

---

### getDateFormat

#### Declaration

```
string getDateFormat([Locale l],[bool isShortFormat])
```

#### Operation

When called with no arguments, this returns the current default short date format. This may be selected for the current user locale, using the Windows Control Panel. If the boolean argument is supplied and is `false`, the default long date format is returned.

---

### Locale type

#### Operation

This type represents any valid user locale value. It can take any of the values supported by the client system.

The perms that take a Locale argument will all return a DXL run-time error if they are supplied with a null value.

---

### for Locale in installedLocales

#### Declaration

```
for Locale in installedLocales
```

#### Operation

This iterator returns all the Locale values installed on the client system.

## Example

```
Locale loc
for loc in installedLocales do
{
    print id(loc) ": " name(loc) "\n"
}
```

---

## for Locale in supportedLocales

---

### Declaration

```
for Locale in supportedLocales
```

### Operation

This iterator returns all the Locale values supported on the client system.

---

## userLocale

---

### Declaration

```
Locale userLocale()
```

### Operation

This returns the current user locale on the client system.

---

## name

---

### Declaration

```
string name(Locale l)
```

### Operation

This returns the name (in the current desktop language) of the specified Locale.

---

## language

---

### Declaration

```
string language(Locale l)
```

### Operation

This returns the English name of the Locale language.

---

## region

---

### Declaration

```
string region(Locale l)
```

### Operation

This returns the English name of the country/region of the Locale.

---

## id

---

### Declaration

```
int id(Locale l)
```

### Operation

This returns the integer identifier value for the Locale. This is a constant for any given Locale.

---

## locale

---

### Declaration

```
Locale locale(int i)
```

### Operation

This returns the Locale for the specified identifier value. It returns null if the integer value is not a valid supported locale identifier.

---

## installed

---

### Declaration

```
bool installed(Locale l)
```

### Operation

This returns true if the Locale is installed on the client machine. Otherwise it returns false.

---

## attributeValue

---

### Declaration

```
bool attributeValue(AttrDef attr, string s[, bool bl])
```

## Operation

Tests whether the supplied string represents a valid value for the specified attribute definition. If the third argument is supplied and set to `true`, the function will return `true` if the attribute base type is date and the string is a valid date string for the user's current Locale setting.

## locale

### Declaration

```
AttrDef.locale()
```

### Operation

Use to access the locale of the specified `AttrDef`. It returns null if there is no locale specified by the attribute definition.

### Example

```
AttrDef ad = find(current Module, "Object Text")
Locale loc = ad.locale
print "Object Text locale is " name(loc) "\n"setLocale
```

## getLegacyLocale

### Declaration

```
Locale getLegacyLocale(void)
```

### Operation

Returns the legacy data locale setting for the database. This determines the locale settings that are used to display legacy attribute data. If none is set, this returns null, and legacy attribute values are displayed according to the settings for the current user locale.

## setLegacyLocale

### Declaration

```
string setLegacyLocale(Locale l)
```

### Operation

This enables users with Manage Database privilege to set the Legacy data locale for the database (as explained above). `setLegacyLocale(null)` removes the Legacy data locale setting for the database. Returns null on success, and an error string on failure, including when it is called by a user without Manage Database privilege.



---

## Single line spacing constant

---

### Declaration

```
int single
```

### Operation

This constant is used to specify single line spacing.

---

## Line spacing constant for 1.5 lines

---

### Declaration

```
int onePointFive
```

### Operation

This constant is used to specify 1.5 lines line spacing.

---

## setLineSpacing

---

### Declaration

```
void setLineSpacing(int lineSpacing)
```

### Operation

Sets line spacing for the current locale.

### Example

```
setLineSpacing(single)
```

---

## getLineSpacing

---

### Declaration

```
int getLineSpacing()
```

### Operation

Retrieves the line spacing for the current locale.

### Example

```
if (getLineSpacing() == onePointFive)
{
    print "Line spacing is set to One and a half lines.\n"
```

```
}

```

---

## setLineSpacing

---

### Declaration

```
void setLineSpacing(Locale locale, int lineSpacing)
```

### Operation

Sets line spacing for the desired locale.

---

## getLineSpacing

---

### Declaration

```
int getLineSpacing(Locale locale)
```

### Operation

Retrieves the line spacing for the desired locale.

---

## getDefaultLineSpacing

---

### Declaration

```
int getDefaultLineSpacing( void)
```

### Operation

Returns the default line spacing for the user's current locale. For example, it will return `single` when the line spacing is European, `onePointFive` when the line spacing is Japanese, Chinese, or Korean, and so on.

---

## getFontSettings

---

### Declaration

```
void getFontSettings(int level, int usedIn, int &size, string &family, bool
&bold, bool &italic, Locale locale)
```

### Operation

Gets the current user's font-related display options for the locale provided. The `usedIn` parameter can be one of the following constants: `HeadingsFont`, `TextFont` or `GraphicsFont`.

### Example

```
int pointSize
string fontFamily
```

```
bool bold, italic
getFontSettings(2, TextFont, pointSize, fontFamily, bold, italic, userLocale)
print fontFamily ", " pointSize ", " bold ", " italic "\n"
```

---

## setFontSettings

---

### Declaration

```
void setFontSettings(int level, int usedIn, int size, string family, bool bold,
bool italics, Locale locale)
```

### Operation

Sets the current user's font-related display options for the locale provided.

---

## for string in availableFonts do

---

### Declaration

```
for string in availableFonts do {}
```

### Operation

Iterator over the specified availableFonts.

### Example

```
string fontName
for fontName in availableFonts do {
...
}
```

Provides access to the names of each of the available fonts.

---

# Codepages

---

## Constants

---

Constants for codepages

The following constants denote codepages:

- `const int CP_LATIN1 // ANSI Latin-1`
- `const int CP_UTF8 // Unicode UTF-8 encoding`

- `const int CP_UNICODE // UTF-16 little-endian encoding (= CP_UTF16_LE)`
- `const int CP_UTF16_LE // UTF-16 little-endian encoding`
- `const int CP_UTF16_BE // UTF-16 big-endian encoding`
- `const int CP_JAP // Japanese (Shift-JIS)`
- `const int CP_CHS // Simplified Chinese (GB2312)`
- `const int CP_KOR // Korean (KSC 5601)`
- `const int CP_CHT // Traditional Chinese (Big 5)`

---

## for int in installedCodepages

---

### Declaration

```
for int in installedCodepages do
```

### Operation

This iterator returns the values of all the codepages installed in the client system.

---

## for int in supportedCodepages

---

### Declaration

```
for int in supportedCodepages do
```

### Operation

This iterator returns the values of all codepages supported by the client system. Some of these may not be currently installed.

---

## currentANSIcodepage

---

### Declaration

```
int currentANSIcodepage()
```

### Operation

Returns the current default ANSI codepage for the client system. For example, in Western Europe and North America this will typically return 1252, equivalent to ANSI Latin-1.

---

## codepageName

---

### Declaration

```
string codepageName(int codepage)
```

## Operation

This returns the name of the specified codepage. Note that this returns an empty string for any codepage that is not installed on the system.

## read

### Declaration

```
Stream read(string filename, int codepage)
```

### Operation

Opens a stream onto the specified filename; content of file decoded from the specified codepage.

## write

### Declaration

```
Stream write(string filename, int codepage)
```

### Operation

Opens a stream onto the specified filename; content of file encoded to the specified codepage.

## append

### Declaration

```
Stream append(string filename, int codepage)
```

### Operation

Opens a stream for append onto the specified filename; content of file encoded to the specified codepage.

## readFile

### Declaration

```
string readFile(string filename, int codepage)
```

### Operation

Reads string from specified file; content is decoded from the specified codepage.

**Note:** The Files function also has a readFile operator. For information about Files and readFile, see “readFile,” on page 136.

---

## isValidChar

---

### Declaration

```
bool isValidChar(char c, int codepage)
```

### Operation

Returns `true` only if the supplied character can be represented in the specified codepage.

---

## convertToCodepage

---

### Declaration

```
{string|Buffer} convertToCodepage(int codepage, {string|Buffer&} utf8string)
```

### Operation

Returns a version of the supplied string or buffer, encoded according to the specified codepage. The supplied string is assumed to be encoded in UTF-8 (the default encoding for all Rational DOORS strings).

**Note:** Only UTF-8 strings will print and display correctly in Rational DOORS V8.0 and higher. This perm is intended for use in exporting string data for use in other applications.

### Example

```
string latin1str = convertToCodepage(CP_LATIN1, "für Elise")
```

---

## convertFromCodepage

---

### Declaration

```
{string|Buffer} convertFromCodepage(int codepage, {string|Buffer&} cpString)
```

### Operation

Converts a string or buffer from the specified codepage to the Rational DOORS default UTF-8 encoding. Once a non-UTF-8 string is converted to UTF-8, it can be displayed and printed by Rational DOORS, including 8-bit (non-ASCII) characters.

### Example

```
int port=5093
int iTimeOut=10
IPC ipcServerConn=server(port)
string inputStr

if (!accept(ipcServerConn))
```

```

{
    print "No connection\n";
}
else while (recv (ipcServerConn, inputStr, iTimeout))
{
    inputStr = convertFromCodepage(currentANSIcodepage(), inputStr)
    print inputStr "\n";
}

```

---

## Message of the day

---

### setMessageOfTheDay

---

#### Declaration

```
string setMessageOfTheDay(string message)
```

#### Operation

This is used to set the message of the text in the database. Returns null if successful, returns an error if the user does not have the manage database privilege.

---

### setMessageOfTheDayOption

---

#### Declaration

```
string setMessageOfTheDayOption(bool setting)
```

#### Operation

Used to turn the message of the day on or off. Returns an error if the user does not have the manage database privilege, otherwise returns null.

---

### getMessageOfTheDay

---

#### Declaration

```
string getMessageOfTheDay()
```

#### Operation

Returns the message of the day if one is set, otherwise returns null.

---

## getMessageOfTheDayOption

---

### Declaration

```
bool getMessageOfTheDayOption()
```

### Operation

Used to determine whether the message of the day is enabled. Returns true if it is enabled, otherwise returns false.

### Example

```
string s1, s2, message
message = "Hello and welcome to DOORS!"

if (getMessageOfTheDayOption()){
    print "Current message of the day is : " (getMessageOfTheDay())
} else {
    print "No message of the day is set, setting message and turning on."
    s1 = setMessageOfTheDay(message)
    if (!null s1){
        print "There was an error setting the message of the day : " s1
    } else {
        s2 = setMessageOfTheDayOption(true)
        if (!null s2){
            print "There was an error turning on the message of the day : " s2
        }
    }
}
```

---

## Database Properties

---

### setLoginFailureText

---

#### Declaration

```
string setLoginFailureText(string msg)
```



## Operation

Sets the string as the pretext for login failure Emails sent through Rational DOORS. Returns null on success or failure error message.

## getLoginFailureText

### Declaration

```
string getLoginFailureText (void)
```

### Operation

Gets the string used for login failure Emails sent through Rational DOORS.

## setDatabaseMailPrefixText

### Declaration

```
string setDatabaseMailPrefixText (string msg)
```

### Operation

Sets the string as the pretext for Emails sent through Rational DOORS. Returns null on success or failure error message.

## getDatabaseMailPrefixText

### Declaration

```
string getDatabaseMailPrefixText (void)
```

### Operation

Gets the string used in Emails sent through Rational DOORS.

## setEditDXLControlled

### Declaration

```
string setEditDXLControlled (bool)
```

### Operation

Activates or de-activates the database wide setting determining whether the ability to edit DXL will be controlled. Returns null on success, or an error on failure.

---

## getEditDXLControlled

---

### Declaration

```
bool getEditDXLControlled(void)
```

### Operation

Used to determine if the ability to edit DXL is controlled in the database. Returns `true` if the ability to edit DXL can be denied.

## Chapter 14

# Rational DOORS database access

This chapter covers:

- Database properties
- Group and user manipulation
- Group and user management
- LDAP
- LDAP Configuration
- LDAP server information
- LDAP data configuration
- Rational Directory Server

---

## Database properties

This section defines functions for Rational DOORS database properties. DXL defines the data type `LoginPolicy`, which can take either of the following values:

```
viaDOORSLogin
```

```
viaSystemLogin
```

These values control how users log in to Rational DOORS, using the Rational DOORS user name or the system login name.

---

### getDatabaseName

---

#### Declaration

```
string getDatabaseName()
```

#### Operation

Returns the name of the Rational DOORS database.

---

### setDatabaseName

---

#### Declaration

```
bool setDatabaseName(string newName)
```

## Operation

Sets the name of the Rational DOORS database to *newName*. If the operation succeeds, it returns `true`; otherwise, it returns `false`. The operation fails if the name contains any prohibited characters.

This perm only operates if the current user has the Manage Database privilege, otherwise it returns false.

## getAccountsDisabled

### Declaration

```
bool getAccountsDisabled()
```

### Operation

If standard and custom user accounts for the current database are disabled, returns `true`; otherwise, returns `false`.

### Example

```
if (getAccountsDisabled()) {
    print "Only those with May Manage Power can
        log in"
}
```

## setAccountsDisabled

### Declaration

```
void setAccountsDisabled(bool disabled)
```

### Operation

Disables or enables standard and custom user accounts for the current database, depending on the value of *disabled*.

This perm only operates if the current user has the Manage Database privilege, otherwise an error message is displayed.

**Note:** A `saveDirectory()` command must be used for this to take effect.

### Example

This example disables all standard and custom user accounts:

```
setAccountsDisabled(false)
saveDirectory()
```

## getDatabaseIdentifier

### Declaration

```
string getDatabaseIdentifier()
```

## Operation

Returns the unique database identifier generated by Rational DOORS during database creation.

### getDatabasePasswordRequired

#### Declaration

```
bool getDatabasePasswordRequired()
```

#### Operation

Returns *true* if passwords are required for the current Rational DOORS database; otherwise, returns *false*.

### setDatabasePasswordRequired

#### Declaration

```
void setDatabasePasswordRequired(bool required)
```

#### Operation

Sets passwords required or not required for the current database, depending on the value of *required*.

This perm only operates if the current user is the administrator, otherwise an error message is displayed.

### getReconfirmPasswordRequired

#### Declaration

```
bool getReconfirmPasswordRequired()
```

#### Operation

Returns *true* if a reconfirmation password is required after a specified timeout period; otherwise, returns *false*.

### setReconfirmPasswordRequired

#### Declaration

```
void setReconfirmPasswordRequired(bool required)
```

#### Operation

Sets whether a reconfirmation password is required after a specified timeout period, depending on the value of *required*.

This perm only operates if the current user has the Manage Database privilege.

---

## getReconfirmPasswordTimeout

---

### Declaration

```
int getReconfirmPasswordTimeout()
```

### Operation

Returns the timeout period (in minutes) before the reconfirmation password dialog appears.

---

## setReconfirmPasswordTimeout

---

### Declaration

```
void setReconfirmPasswordTimeout(int timeout)
```

### Operation

Sets the timeout period to *timeout* minutes before the reconfirmation password dialog appears.

This perm only operates if the current user has the Manage Database privilege.

---

## getRequireLettersInPassword

---

### Declaration

```
bool getRequireLettersInPassword()
```

### Operation

Returns *true* if a password is required to contain at least one alphabetic character; otherwise, returns *false*.

---

## setRequireLettersInPassword

---

### Declaration

```
string setRequireLettersInPassword(bool required)
```

### Operation

If *required* is true, then a password is required to contain at least one alphabetic character.

This perm only operates if the current user has the Manage Database privilege, otherwise an error message is returned.

---

## getRequireNumberInPassword

---

### Declaration

```
bool getRequireNumberInPassword()
```

## Operation

Returns *true* if a password is required to contain at least one number; otherwise, returns *false*.

## setRequireNumberInPassword

### Declaration

```
string setRequireNumberInPassword (bool required)
```

### Operation

If *required* is *true*, a password is required to contain at least one number.

This perm only operates if the current user has the Manage Database privilege, otherwise an error message is returned.

## getRequireSymbolInPassword

### Declaration

```
bool getRequireSymbolInPassword ()
```

### Operation

Returns *true* if a password is required to contain at least one non-alphanumeric character; otherwise, returns *false*.

## setRequireSymbolInPassword

### Declaration

```
string setRequireSymbolInPassword (bool required)
```

### Operation

If *required* is *true*, a password is required to contain at least one non-alphanumeric character.

This perm only operates if the current user has the Manage Database privilege, otherwise an error message is returned.

## getDatabaseMinimumPasswordLength

### Declaration

```
int getDatabaseMinimumPasswordLength ()
```

### Operation

Returns the minimum number of characters required for a password on the current database.

---

## setDatabaseMinimumPasswordLength

---

### Declaration

```
void setDatabaseMinimumPasswordLength(int length)
```

### Operation

Sets the length of password required for the current database to *length* characters. The value can be any non-negative integer.

This perm only operates if the current user has the Manage Database privilege.

---

## getMinPasswordGeneration

---

### Declaration

```
int getMinPasswordGeneration()
```

### Operation

Returns the minimum number of password generations before a password can be reused.

---

## setMinPasswordGeneration

---

### Declaration

```
string setMinPasswordGeneration(int num)
```

### Operation

Sets the minimum number of password generations before a password can be reused to *num*. The minimum number cannot exceed the in-built maximum limit of 12 generations before a password can be reused.

This perm only operates if the current user has the Manage Database privilege, otherwise an error message is returned.

---

## getMaxPasswordGenerationLimit

---

### Declaration

```
int getMaxPasswordGenerationLimit()
```

### Operation

Returns the in-built maximum limit of password generations before a password can be reused. This maximum limit is set to 12.



---

## getMinPasswordAgeInDays

---

### Declaration

```
int getMinPasswordAgeInDays()
```

### Operation

Returns the minimum number of days before a password can be reused.

---

## setMinPasswordAgeInDays

---

### Declaration

```
string setMinPasswordAgeInDays(int days)
```

### Operation

Sets the minimum number of days before a password can be reused to days. The minimum number cannot exceed the in-built maximum limit of 180 days before a password can be reused.

This perm only operates if the current user has the Manage Database privilege, otherwise an error message is returned.

---

## getMaxPasswordAgeLimit

---

### Declaration

```
int getMaxPasswordAgeLimit()
```

### Operation

Returns the in-built maximum limit of days before a password can be reused. This maximum limit is set to 180 days.

---

## getDatabaseMailServer

---

### Declaration

```
string getDatabaseMailServer(void)
```

### Operation

Returns as a string the name of the SMTP mail server for Rational DOORS.

---

## setDatabaseMailServer

---

### Declaration

```
void setDatabaseMailServer(string serverName)
```

## Operation

Sets the mail server for the current database to *serverName*.

This perm only operates if the current user has the Manage Database privilege.

## getDatabaseMailServerAccount

### Declaration

```
string getDatabaseMailServerAccount(void)
```

### Operation

Returns as a string the name of the mail account that appears to originate messages from Rational DOORS.

## setDatabaseMailServerAccount

### Declaration

```
void setDatabaseMailServerAccount(string accountName)
```

### Operation

Sets to *accountName* the mail account that appears to originate messages from Rational DOORS.

This perm only operates if the current user has the Manage Database privilege.

## getLoginPolicy

### Declaration

```
LoginPolicy getLoginPolicy()
```

### Operation

Returns the login policy (either *viaDOORSLogin* or *viaSystemLogin*) for the current database. These values control how users log in to Rational DOORS, using the Rational DOORS name or the system login name.

## setLoginPolicy

### Declaration

```
void setLoginPolicy(LoginPolicy policy)
```

### Operation

Sets the login policy for the current database to *policy*, which can be either *viaDOORSLogin* or *viaSystemLogin*.

This perm only operates if the current user has the Manage Database privilege, otherwise an error message is displayed.

---

## getDisableLoginThreshold

---

### Declaration

```
int getDisableLoginThreshold()
```

### Operation

Returns the number of times a user account tolerates a failed login. If the number of login failures to any single account exceeds this value, Rational DOORS disables that account. Nobody can use a disabled account.

If the return value is zero, there is no limit. See also the `getFailedLoginThreshold` function.

---

## setDisableLoginThreshold

---

### Declaration

```
void setDisableLoginThreshold(int attempts)
```

### Operation

Sets the number of times a user account tolerates a failed login. If the number of login failures to any single account exceeds this value, Rational DOORS disables that account. Nobody can use a disabled account.

If *attempts* is zero, there is no limit. See also the `setFailedLoginThreshold` function.

This perm only operates if the current user has the Manage Database privilege, otherwise an error message is displayed.

---

## getFailedLoginThreshold

---

### Declaration

```
int getFailedLoginThreshold()
```

### Operation

Returns the number of times Rational DOORS tolerates a login failure. If this threshold is exceeded, Rational DOORS closes.

If the return value is zero, there is no limit. See also the `setDisableLoginThreshold` function.

---

## setFailedLoginThreshold

---

### Declaration

```
void setFailedLoginThreshold(int attempts)
```

### Operation

Sets the number of times Rational DOORS tolerates a login failure. If this threshold is exceeded, Rational DOORS closes.

If *attempts* is zero, there is no limit. See also the `setDisableLoginThreshold` function.

This perm only operates if the current user has the Manage Database privilege, otherwise an error message is displayed.

**Note:** A `saveDirectory()` command must be used for this to take effect.

### Example

```
setFailedLoginThreshold(3)
saveDirectory()
```

## getLoginLoggingPolicy

### Declaration

```
bool getLoginLoggingPolicy(bool type)
```

### Operation

If Rational DOORS is keeping track of logins of the specified type, returns `true`; otherwise, returns `false`. If `type` is `true`, returns the policy for successful logins; otherwise, returns the policy for login failures.

To set the logging policy, use the `setLoginLoggingPolicy` function.

### Example

This example indicates whether Rational DOORS is keeping track of login failures.

```
getLoginLoggingPolicy(false)
```

## setLoginLoggingPolicy

### Declaration

```
void setLoginLoggingPolicy(bool type,
                           bool status)
```

### Operation

Sets the logging policy for login events of the specified type. If `status` is `true`, logging of the specified type is enabled; otherwise, it is disabled. If `type` is `true`, sets the policy for successful logins; otherwise, sets the policy for login failures.

To find out the current logging policy, use the `getLoginLoggingPolicy` function.

### Example

This example causes Rational DOORS not to log successful logins.

```
setLoginLoggingPolicy(true, false)
```

## setMinClientVersion

### Declaration

```
string setMinClientVersion(string s)
```

## Operation

Sets the minimum client version that can connect to the current database. The string argument must be of the format *n.n*, *n.n.n* or *n.n.n.n*, where each *n* is a decimal integer. The integer values represent Major version, Minor version, Service Release and Patch number respectively. The Service Release and Patch numbers are optional, and default to zero.

This perm only operates if the current user has the Manage Database privilege, otherwise it returns an appropriate error string. It also returns an error string if the string argument is not of the correct format, or represents a client version higher than the current client.

## getMinClientVersion

### Declaration

```
string getMinClientVersion(void)
```

### Operation

Returns a string representing the minimum client version that can connect to the current database, in the format *n.n*, *n.n.n* or *n.n.n.n*. The format is explained in `setMinClientVersion`. If no minimum client version has been set for the database, this perm returns a NULL string.

## setMaxClientVersion

### Declaration

```
string setMaxClientVersion(string s)
```

### Operation

Sets the maximum client version that can connect to the current database. The string argument must be of the format *n.n*, *n.n.n* or *n.n.n.n*, where each *n* is a decimal integer. The integer values represent Major version, Minor version, Service Release and Patch number respectively. The Service Release and Patch numbers are optional.

This perm only operates if the current user has the Manage Database privilege, otherwise it returns an appropriate error string. It also returns an error string if the string argument is not of the correct format, or represents a client version lower than the current client.

## getMaxClientVersion

### Declaration

```
string getMaxClientVersion(void)
```

### Operation

Returns a string representing the maximum client version that can connect to the current database, in the format *n.n*, *n.n.n* or *n.n.n.n*. The format is explained in `setMinClientVersion`. If no minimum client version has been set for the database, this perm returns a null string.

---

## doorsInfo

---

### Declaration

```
string doorsInfo(int i)
```

### Operation

A new valid value for the integer argument is defined (`infoServerVersion`).

This returns the version of the database server to which the client is currently connected.

### Example

```
string serverVersion = doorsInfo(infoServerVersion)
print "database server version is " serverVersion "\n"
```

---

## addNotifyUser

---

### Declaration

```
void addNotifyUser(User user)
```

### Operation

Adds *user* to the list of users to be notified by e-mail of attempts to log in. If *user* does not have an e-mail address, no notification takes place.

---

## deleteNotifyUser

---

### Declaration

```
void deleteNotifyUser(User user)
```

### Operation

Deletes *user* from the list of users to be notified by e-mail of attempts to log in.

---

## createPasswordDialog

---

### Declaration

```
string createPasswordDialog(DB parent,
                             bool &completed)
```

### Operation

Displays a dialog box containing password and password confirmation fields as well as **OK** and **Cancel** buttons. The parent argument is needed for the Z-order of the elements.

If confirmation is successful, returns a null string; otherwise, returns an error message.

If the user clicks **OK**, sets *completed* to `true`. If the user clicks **Cancel**, sets *completed* to `false`. Rational DOORS stores the entered password temporarily for the next user account created with the `addUser` function. It is not stored as plain text, and is lost if Rational DOORS shuts down before a new account is created.

## Example

See the section “Creating a user account example,” on page 228.

---

## changePasswordDialog

---

### Declaration

```
string changePasswordDialog(DB parent,
                           User user,
                           bool masquerade,
                           bool &completed)
```

### Operation

Displays a dialog box containing password and password confirmation fields as well as **OK** and **Cancel** buttons. The *parent* argument is needed for the Z-order of the elements.

If confirmation is successful, returns a null string; otherwise, returns an error message.

If the user clicks **OK**, sets *completed* to `true`. If the user clicks **Cancel**, sets *completed* to `false`. Rational DOORS stores the entered password temporarily. It is not stored as plain text, and is lost if Rational DOORS shuts down before the password is copied using the `copyPassword` function.

A user without the `mayEditUserList` power must confirm his existing password, otherwise the function returns an error message. A user with this power is not prompted for an existing password, unless *masquerade* is `true`.

### Example

This example copies a new password to the user account for which it was created.

```
User u = find("John Smith")
bool completed
string s = changePasswordDialog(confirm, u,
                                false, completed)
if (completed && (null s)){
    copyPassword()
}
saveUserRecord(u)
saveDirectory()
```

---

## confirmPasswordDialog

---

### Declaration

```
bool confirmPasswordDialog(DB parent,
                          bool &completed)
```

### Operation

Displays a dialog box containing a password confirmation field as well as **OK** and **Cancel** buttons. The title of the dialog box is always **Confirm password - DOORS**. The *parent* argument is needed for the Z-order of the elements.

If confirmation is successful, returns `true`; otherwise, returns `false`.

If the user clicks **OK**, sets `completed` to `true`. If the user clicks **Cancel**, sets `completed` to `false`.

### Example

```
bool bPasswordOK = false, bCompleted = false
// query user
bPasswordOK = confirmPasswordDialog(dbExplorer, bCompleted)
// check status
if (bCompleted == true)
{
    print "Confirmed"
}
```

---

## copyPassword

---

### Declaration

```
bool copyPassword()
```

### Operation

Copies the password created using the function to the account for which the password was created. Returns null on success and an error message on failure.

### Example

This example copies a new password to the user account for which it was created.

```
User u = find("John Smith")
bool completed
string s = changePasswordDialog(dbExplorer, u, false, completed)
if (completed && (null s)){
    copyPassword()
}
```



---

## getAdministratorName

---

### Declaration

```
string getAdministratorName()
```

### Operation

Returns the name of the administrator for the Rational DOORS database.

---

## sendEMailNotification

---

### Declaration

```
{bool|string} sendEMailNotification(string fromDescription,
                                     string targetAddress,
                                     string subject,
                                     string message)
```

```
string sendEMailNotification(string fromDescription,
                              Skip targetAddresses,
                              [, Skip ccAddresses]
                              [, Skip bccAddresses]
                              string subject,
                              string message)
```

### Operation

Issues a notification e-mail to the specified address or addresses. The communication takes place using SMTP, and depends on the appropriate Database Properties fields being correctly set up prior to its use (SMTP Mail Server and Mail Account).

The user can set the description of the sender, the subject matter, and message contents using *fromDescription*, *subject* and *message*. If *fromDescription* is a null string, Rational DOORS defaults to a standard text:

```
DOORS Mail Server
```

The following standard text is sent in front of the specified message:

```
The following is a notification message from DOORS - please do not reply as it
was sent from an unattended mailbox.
```

The variant returning a boolean is for legacy use and returns `true` if the SMTP communication was successful; otherwise, returns `false`. Others variants return an error string on failure.

---

## sendEMailMessage

---

### Declaration

```
{bool|string} sendEMailMessage(
    string fromDescription,
    string targetAddress,
    string subject,
    string message)

string sendEMailMessage(
    string fromDescription,
    Skip targetAddress,
    [, Skip ccAddresses]
    [, Skip bccAddresses]
    string subject,
    string message)
```

### Operation

Performs the same function as `sendEMailNotification`, but without prepending text to the message.

---

## Creating a user account example

---

This example creates a new user account named John Smith, having johns as its login name, with whatever password is entered in the dialog box.

```
// prevent dxl timeout dialog
pragma runLim, 0
// globals
bool g_bPasswordOK = true
// user details
const string sUserName = "John Smith"
const string sUserLogin = "johns"
// only relevant if password is required
if (getDatabasePasswordRequired() == true) {
    bool bConfirmCompleted = false
    // query user
    g_bPasswordOK =
        confirmPasswordDialog(dbExplorer,
                               bConfirmCompleted)

    // check status
```

```

    if (bConfirmCompleted == false) {
        // adjust accordingly
        g_bPasswordOK = false
    }
}

// check status

if (g_bPasswordOK == true) {
    // only relevant if name doesn't exist
    // as group or user

    if (existsUser(sUserName) == false &&
        existsGroup(sUserName) == false) {
        bool bCreateCompleted = false
        // query user

        string sErrorMsg =
            createPasswordDialog(dbExplorer,
                bCreateCompleted)

        // check status

        if (sErrorMsg == null &&
            bCreateCompleted == true) {
            // add new user

            if (addUser(sUserName, sUserLogin) ==
                null) {
                // save new user list
                if (saveDirectory() == null) {
                    // refresh
                    if (loadDirectory() == null) {
                        // inform user

                        infoBox("User '"sUserName"'
                            was added successfully.\n")

                    } else {
                        // warn user
                        warningBox("Failed to load
                            user list.\n")

                    }

                } else {
                    // warn user
                    warningBox("Failed to save
                        user list.\n")

                }

            } else {
                // warn user
                warningBox("Failed to add user
                    '"sUserName"'.\n")

            }

        }

    }
}

```

```

    } else {
        // warn user
        warningBox(sErrorMsg)
    }
} else {
    // warn user
    warningBox("The name '"sUserName"'
        already exists as either a DOORS User or
        Group.\n")
}
}
}

```

---

## Group and user manipulation

Group and user manipulation functions and for loops use the following DXL data types: `Group`, `User`, `GroupList`, `UserList`, and `UserNotifyList`. These types have the following permitted values:

Type	Constant	Meaning
<code>GroupList</code>	<code>groupList</code>	Provides access to all groups defined in the database. This is the only constant of type <code>GroupList</code> .
<code>UserList</code>	<code>userList</code>	Provides access to all users (with the exception of the administrator account) who have an account in the database. This is the only constant of type <code>UserList</code> .
<code>UserNotifyList</code>	<code>userNotifyList</code>	Provides access to all users who must be notified by e-mail of attempts to log in. This is the only constant of type <code>UserNotifyList</code> .

---

## find

### Declaration

```

User find()
{Group|User} find(string name)

```

### Operation

The first form returns a handle of type `User` to the currently logged in user.

The second form returns a handle of type `Group` or type `User` for the group or user name. A call to this function where *name* does not exist causes a DXL run-time error. To check that a user or group exists, use the `existsGroup`, `existsUser` functions.

---

## findByID

---

### Declaration

```
User findByID(string identifier)
```

### Operation

Returns a handle of type `User` for the specified *identifier*, or null if the user does not exist but the identifier is valid. If the specified identifier is badly formed, a DXL run-time error occurs.

You can extract the identifier for a user from a variable of type `User` with the `identifier` property (see “Group and user properties,” on page 239).

---

## existsGroup, existsUser

---

### Declaration

```
bool existsGroup(string name)
```

```
bool existsUser(string name)
```

### Operation

If the named group or user exists, returns `true`; otherwise, returns `false`.

---

## loadUserRecord

---

### Declaration

```
string loadUserRecord(User user)
```

### Operation

Loads the details of user *user* from the database.

### Example

```
User u = find("boss")
loadUserRecord(u)
string e = u.email
print e
```

---

## ensureUserRecordLoaded

---

### Declaration

```
string ensureUserRecordLoaded(User user)
```

### Operation

If the user's record for user has not already been loaded, calls the `loadUserRecord` function.

---

## saveUserRecord

---

### Declaration

```
string saveUserRecord(User user)
```

### Operation

Saves the details of user `user` to the database.

**Note:** A `saveDirectory()` command should be used to commit the changes to the database

### Example

```
User u = find("boss")
loadUserRecord(u)
string e = u.email
if (null e) {
    u.email = "boss@work"
}
saveUserRecord (u)
saveDirectory()
```

---

## loadDirectory

---

### Declaration

```
string loadDirectory()
```

### Operation

Loads the group and user list from the database. All changes made since the last load or save are lost. If the operation succeeds, returns null; otherwise, returns an error message.

---

## saveDirectory

---

### Declaration

```
string saveDirectory()
```

### Operation

Saves all changes to groups, users, and login policies in the database. If the call fails, returns an error message.

**Note:** This perm places a temporary lock on the users directory. If used in a continuous manner, for example, repeatedly in a `for` loop, this could cause conflicts for another user trying to login.

---

## for user in database

---

### Syntax

```
for user in userList do {
    ...
}
```

where:

*user* is a variable of type `User`

If the database is configured to use an LDAP directory, use:

```
for user in userList("pattern") do {
    ...
}
```

### Operation

Assigns the variable *user* to be each successive non-administrator user in the database.

For LDAP, if the pattern specified is `*`, then the loop returns the entire set of users that are available in the LDAP directory. This operation might require some time, depending on the number of users in the LDAP directory.

### Example

This example prints a list of users in the database:

```
User user
for user in userList("*") do {
    string uName = user.name
    print uName "\n"
}
```

---

## for group in database

---

### Syntax

```
for group in groupList do {  
    ...  
}
```

where:

*group* is a variable of type Group

If the database is configured to use an LDAP directory, use:

```
for group in groupList("pattern") do {  
    ...  
}
```

### Operation

Assigns the variable *group* to be each successive group in the database.

For LDAP, if the pattern specified is \*, then the loop returns the entire set of groups that are available in the LDAP directory. This operation might require some time, depending on the number of groups in the LDAP directory.

### Example

This example prints a list of groups in the database:

```
Group group  
  
for group in groupList("*") do {  
    string gName = group.name  
    print gName "\n"  
}
```

---

## for user in group

---

### Syntax

```
for user in group do {  
    ...  
}
```

where:

*user* is a variable of type User

*group* is a variable of type Group



## Operation

Assigns the variable *user* to be each successive non-administrator user in the specified group.

## Example

This example prints a list of users in group development:

```
User user
Group development = find("development")
for user in development do {
    string uName = user.name
    print uName "\n"
}
```

## for group in ldapGroupsForUser

### Declaration

```
for g in ldapGroupsForUser(u) do {
    ...
}
```

where:

<i>g</i>	is a variable of type Group
<i>u</i>	is a variable of type User

### Operation

Iterate over all groups of which the user passed to the *ldapGroupsForUser* function is a member. Note that this iterator is only effective when Rational DOORS is configured for LDAP, not for the Rational Directory Server.

### Example

```
User u = find("fred")
Group g
for g in ldapGroupsforUser(u) do {
    ...
}
```

## for user in notify list

### Syntax

```
for user in userNotifyList do {
    ...
}
```

where:

`user` is a variable of type `User`

## Operation

Assigns the variable `user` to be each successive user in the list of users to be notified by e-mail of login activity.

## copyPassword

### Declaration

```
string copyPassword()
```

### Operation

This is the same as the existing `copyPassword()` perm. It performs an identical operation, transferring the shadow password to the real password but instead of returning a boolean indicating success or failure, it returns NULL on success and a message on failure. The existing perm can fail resulting in a reported error in the DXL output display if an exception is thrown. The new perm will catch exceptions and pass the message back to the DXL code for it to display as a pop-up dialog.

## fullName

### Declaration

```
UserElement_ fullName()
```

### Operation

This can be used to get the full name of the user.

### Example

```
User u = find()
string name = u.fullName
```

## mayEditDXL

### Declaration

```
UserElement_ mayEditDXL()
```

### Operation

Indicates whether the specified user is able to edit and run DXL programs.

### Example

```
User u = find
bool useDXL = u.mayEditDXL
```

---

## synergyUsername

---

### Declaration

```
UserElement_ synergyUsername ()
```

### Operation

This can be used to retrieve the user's SYNERGY/Change user name.

This attribute value is only available when Rational DOORS is configured to use the Rational Directory Server.

This value is not writable; its value is set when the `systemLoginName` is set.

### Example:

```
User u = find("Test")
string s = u.synergyUsername
User u = find("Test")
u.synergyUsername = "testuser"
//this generates an error
```

---

## forename

---

### Declaration

```
UserElement_ forename ()
```

### Operation

This can be used to get or set the user's forename.

This attribute value is only available when Rational DOORS is configured to use the Rational Directory Server.

Setting this value has the side effect of setting the `fullName` of the user to the concatenation of forename and surname.

This is only relevant when configured to use the Rational Directory Server.

### Example

```
User u = find("Test")
string s = u.forename

User u = find("Test")
u.forename = "Tom"
```

---

## surname

---

### Declaration

```
UserElement_ surname ()
```

### Operation

This can be used to get or set the user's surname.

This attribute value is only available when Rational DOORS is configured to use the Rational Directory Server.

Setting this value has the side effect of setting the `fullName` of the user to the concatenation of forename and surname. This is only relevant when configured to use the Rational Directory Server.

### Example

```
User u = find("Test")
string s = u.surname
```

```
User u = find("Test")
u.surname = "Thumb"
```

---

## Group and user management

Group and user management functions use the DXL data types `Group`, `User`, and `UserClass`.

---

### User class constants

---

Type `UserClass` can have one of the following values:

Constant	Meaning
<code>administrator</code>	User type administrator
<code>standard</code>	User type standard
<code>databaseManager</code>	User type database manager
<code>projectManager</code>	User type project manager
<code>custom</code>	User type custom

---

## Group and user properties

---

Properties are defined for use with the `.` (dot) operator and a group or user handle to extract information from, or specify information in a group or user record, as shown in the following syntax:

*variable.property*

where:

*variable* is a variable of type Group or User

*property* is one of the user or group properties

The following tables list the group properties and the information they extract or specify (for further details on specifying information see the `setGroup` function):

String property	Extracts
name	name

Boolean property	Extracts
Disabled	whether the group is disabled

The following tables list the user properties and the information that they extract or specify.

**Note:** The string properties and Boolean properties in the following tables do not apply to the following DXL statements. These statements only use one property, the Boolean property `Disabled`:

- `for` property in user account
- `isAttribute(user)`
- `delete(user property)`
- `get(user property)`
- `set(user property)`

For further details on specifying information, see the `setUser` function.

String property	Extracts
address	postal address
email	e-mail address
identifier	identifier: a string containing a hexadecimal number, which is created by Rational DOORS
description	description

<b>String property</b>	<b>Extracts</b>
name	name
password	password (write-only)
systemLoginName	system login name (not Rational DOORS user name)
telephone	telephone number
fullName	full name

<b>Boolean property</b>	<b>Extracts</b>
Disabled	whether the account is disabled
emailCPUpdates	whether the user of the CP system can be notified by e-mail when the status of a proposal changes, for example when it is accepted or rejected
mayArchive	whether the user can archive and restore modules and projects
mayCreateTopLevelFolders	whether the user can create folders at the root of the database
mayEditGroupList	whether the user can edit, create and delete groups
mayEditUserList	whether the user can edit, create, and delete user accounts and groups
mayManage	whether the user can manage the Rational DOORS database
mayPartition	whether the user can transfer the editing rights for a module to a satellite database (see the chapters on partitions in <b>Using Rational DOORS</b> and <b>Managing Rational DOORS</b> )
passwordChanged	whether the password has been changed since the account was created
passwordMayChange	whether the user is permitted to change the password
mayUseCommandLinePassword	if database restrictions are enabled, whether the user may use the command line password switch
additionalAuthenticationRequired	whether the user is required to perform additional authentication when logging in (RDS only)

Integer property	Extracts
<code>passwordLifetime</code>	lifetime of password (0 means unlimited lifetime)
<code>passwordMinimumLength</code>	minimum number of characters in password for this user (non-negative integer)

Type <code>UserClass</code> property	Extracts
<code>class</code>	class of user; this can be one of the values in “User class constants,” on page 238

---

## for property in user account

---

### Syntax

```
for Boolean property Disabled in user do {
  ...
}
```

where:

Boolean property	Extracts
<code>Disabled</code>	whether the user is disabled

### Operation

Assigns `Boolean property Disabled` to each successive user.

---

## isAttribute(user)

---

### Declaration

```
bool isAttribute(User user, Boolean property Disabled)
```

### Operation

Returns `true` if the specified user contains the `Boolean property Disabled`; otherwise, returns `false`.

---

## isAttribute(user attribute)

---

### Declaration

```
bool isAttribute(User user, string attribute)
```

## Operation

Returns true if the specified user contains the string *attribute*; otherwise, returns false.

## Example

```
User u = find("Test")
string attr = "key"
bool b = isAttribute(u, attr)
```

## isAttribute(group attribute)

### Declaration

```
bool isAttribute(Group group, string attribute)
```

### Operation

Returns true if the specified group contains the string *attribute*; otherwise, returns false.

### Example

```
Group g = find("Developers")
string attr = "key"
bool b = isAttribute(g, attr)
```

## delete(user attribute)

### Declaration

```
void delete(User user, string attribute)
```

### Operation

Deletes the specified string *attribute* if found within user.

## delete(group attribute)

### Declaration

```
void delete(Group group, string attribute)
```

### Operation

Deletes the specified string *attribute* if found within group.



---

## delete(user property)

---

### Declaration

```
void delete(User user, Boolean property Disabled)
```

### Operation

Deletes the `Boolean property Disabled` within `user`. You cannot delete properties of other types.

This action takes effect after `saveUserRecord` has been called. It is then permanent and cannot be reversed.

---

## get(user property)

---

### Declaration

```
string get(User user, Boolean property Disabled)
```

### Operation

Returns the value of the `Boolean property Disabled` within `user`. If the property does not exist, a DXL run-time error occurs.

---

## get(user attribute)

---

### Declaration

```
string get(User user, string attribute)
```

### Operation

Returns the value of the string `attribute` within `user`. If the property does not exist, a DXL run-time error occurs.

### Example

```
User u = find("Test")
string attr = "key"
string val = get(u, attr)

print val
```

---

## get(group attribute)

---

### Declaration

```
string get(Group group, string attribute)
```

## Operation

Returns the value of the string *attribute* within *group*. If the property does not exist, a DXL run-time error occurs.

## Example

```
Group g = find("Developers")
string attr = "key"
string val = get(g, attr)

print val
```

## set(user property)

### Declaration

```
void set(User user, Boolean property Disabled, string value)
```

### Operation

Updates the value of the Boolean *property Disabled* within *user*. If the property does not exist it is created.

## set(user attribute)

### Declaration

```
void set(User user, string attribute, string value)
```

### Operation

Updates the value of the string *attribute* to the specified *value*. If the attribute does not exist it is created.

### Example

```
User u = find("Test")
string attr = "key"
string val = "value"

set(u, attr, val)
```

## set(group attribute)

### Declaration

```
void set(Group group, string attribute, string value)
```

## Operation

Sets the string *attribute* to the specified *value*. If the attribute does not exist it is created.

## Example

```
Group g = find("Developers")
string attr = "key"
string val = "value"

set(g, attr, val)
```

## setGroup

### Declaration

```
string setGroup(Group id,
                property,
                {string|bool} value)
```

### Operation

Updates the value of the specified standard property (from the String property table) within the group *id*.

If successful, returns a null string; otherwise, returns an error message.

## setUser

### Declaration

```
string setUser(User user,
               property,
               {string|int|bool} value)
```

### Operation

Updates the value of the specified standard property (from the String property table) within *user*.

If successful, returns a null string; otherwise, returns an error message.

## addGroup

### Declaration

```
string addGroup(string name)
```

### Operation

Creates group *name*. If the operation is successful, returns a null string; otherwise, returns an error message.

---

## deleteGroup

---

### Declaration

```
string deleteGroup(Group group)
```

### Operation

Deletes group *group* from the Rational DOORS database. It does not affect underlying users.

This action takes effect after the user directory has been refreshed using the `saveDirectory` function. It is then permanent and cannot be reversed.

If the operation is successful, returns a null string; otherwise, returns an error message.

---

## addUser

---

### Declaration

```
string addUser(string name,  
              string uid)  
  
string addUser(string name,  
              string password  
              string uid)
```

### Operation

The first form creates a user account with the specified *name*, and system login, *uid*. If the operation succeeds returns a null string; otherwise, returns an error message. This function must be used after a call to the `createPasswordDialog` function, so that the password is set to an initial value. The user must change the password on first use. If there has been no previous call to the `createPasswordDialog` function, the password is set to a null string.

The second form is only supported for compatibility with earlier releases. It is deprecated because passwords are passed as plain text.

This action takes effect after the user directory has been refreshed using the `saveDirectory` function.

### Example

See the section “Creating a user account example,” on page 228.

---

## deleteUser

---

### Declaration

```
string deleteUser(User user)
```

### Operation

Deletes the *user* account for user from the Rational DOORS database. Appropriate e-mails are also issued to the same people who are notified of unsuccessful logins.

This action takes effect after the user directory has been refreshed using the `saveDirectory` function. It is then permanent and cannot be reversed.

If the operation is successful, returns a null string; otherwise, returns an error message.

---

## addMember

---

### Declaration

```
void addMember(Group group,
               User user)
```

### Operation

Adds user *user* to group *group*.

This action takes effect after the user directory has been refreshed using the `saveDirectory` function.

---

## deleteMember

---

### Declaration

```
bool deleteMember(Group group,
                  User user)
```

### Operation

Deletes user *user* from group *group*. If the operation succeeds, returns `true`; otherwise, returns `false`.

This action takes effect after the user directory has been refreshed using the `saveDirectory` function.

---

## deleteAllMembers

---

### Declaration

```
bool deleteAllMembers(Group group)
```

### Operation

Deletes all users from group *group*.

This action takes effect after the user directory has been refreshed using the `saveDirectory` function.

---

## member

---

### Declaration

```
bool member(Group group,
            User user)
```

## Operation

If user *user* is a member of group *group*, returns `true`; otherwise returns `false`.

---

### stringOf(user class)

---

#### Declaration

```
string stringOf(UserClass userClass)
```

#### Operation

Returns a string representation of the specified user class. This can be one of the following values:

"Administrator"

"Standard"

"Database Manager"

"Project Manager"

"Custom"

---

## LDAP

---

### saveLdapConfig()

---

#### Declaration

```
string saveLdapConfig()
```

#### Operation

Save the LDAP configuration to the database. Returns empty string on success, error message on failure.

---

### loadLdapConfig()

---

#### Declaration

```
string loadLdapConfig()
```

#### Operation

Load the LDAP configuration from the database. Returns empty string on success, error message on failure.

---

## getUseLdap()

---

### Declaration

```
bool getUseLdap()
```

### Operation

Gets the value of the flag which determines if we are using LDAP for storage of user and group information.

---

## setUseLdap()

---

### Declaration

```
string setUseLdap(bool usingLdap)
```

### Operation

Sets the value of the flag which determines if we are using LDAP for storage of user and group information. Only the administrator can set this value. Returns empty string on success, error message on failure.

---

## updateUserList()

---

### Declaration

```
string updateUserList()
```

### Operation

Update the Rational DOORS user list from the LDAP user list. Creates standard users for all the users permitted by LDAP if they do not already exist in the Rational DOORS database, and updates user name and system login name for existing users.

**Note:** This operation can take a long time, particularly if no group of Rational DOORS users has been specified (see `setDoorsUserGroupDN`).

---

## updateGroupList()

---

### Declaration

```
string updateGroupList()
```

### Operation

Update the Rational DOORS group list from the LDAP group list. Creates Rational DOORS groups for all the groups permitted by LDAP if they do not already exist in the Rational DOORS database, and updates group name for existing groups.

**Note:** This operation can take a long time, particularly if no group of Rational DOORS groups has been specified (see `setDoorsGroupGroupDN`).

---

# LDAP Configuration

---

---

## findUserRDNFromName

---

### Declaration

```
string findUserRDNFromName(string name, bool &unique, string &uid)
```

### Operation

Search for *name* in the LDAP directory, in the attribute specified by name for Rational DOORS user names, in the Rational DOORS user subtree.

If found, return the distinguished name of the entry, relative to the Rational DOORS user root. Also sets the unique flag `true` if only one matching entry was found, and fills in the `uid` string with the system login name obtained from the matching entry. If not found, returns `NULL`. Only the administrator can run this function.

---

## findUserRDNFromLoginName

---

### Declaration

```
string findUserRDNFromLoginName(string uid, bool &unique, string &name)
```

### Operation

Search for `uid` in the LDAP directory, in the attribute specified for system login names, in the Rational DOORS user subtree.

If found, return the distinguished name of the entry, relative to the Rational DOORS user root. Also sets the unique flag `true` if only one matching entry was found, and fills in the `name` string with the Rational DOORS user name obtained from the matching entry. If not found, returns `NULL`. Only the administrator can run this function.

---

## findGroupRDNFromName

---

### Declaration

```
string findGroupRDNFromName(string name, bool &unique)
```

### Operation

Search for *name* in the LDAP directory, in the attribute specified for Rational DOORS group names, in the Rational DOORS group subtree.

If found, return the distinguished name of the entry, relative to the Rational DOORS group root. Also sets the unique flag `true` if only one matching entry was found. If not found, returns `NULL`. Only the administrator can run this function.



---

## findUserInfoFromDN

---

### Declaration

```
string findUserInfoFromDN(string dn, string &name, string &uid)
```

### Operation

Search for an entry with distinguished name `dn` in the LDAP directory.

If found, fills in the `name` and `uid` with the Rational DOORS user name and system login name obtained from the matching entry. Returns `NULL`. Only the administrator can run this function.

---

## checkConnect

---

### Declaration

```
string checkConnect()
```

### Operation

Check the current LDAP configuration by attempting to connect to the specified server/port as the user specified by Rational DOORS bind `dn` with the Rational DOORS bind password. Returns `NULL` on success, error message on failure.

---

## checkDN

---

### Declaration

```
string checkDN(string dn)
```

### Operation

Check that the given `dn` is a valid entry in the directory specified by the current LDAP configuration. This can be run to check that the user `root`, group `root`, user group `dn`, and group `group dn` have been set to existing values. Only the administrator can run this function.

### Example

```
LdapItem item
for item in ldapGroupList do
{
    print item.name "\n"
    print item.dn "\n"
    print item.uid "\n"
}

for item in ldapUserList do
```

```
{  
    print item.name "\n"  
    print item.dn "\n"  
    print item.uid "\n"  
}
```

---

## LDAP server information

---

---

### getLdapServerName

---

#### Declaration

```
string getLdapServerName()
```

#### Operation

Gets the name of the LDAP server.

---

---

### setLdapServerName(string)

---

#### Declaration

```
string setLdapServerName(string name)
```

#### Operation

Sets the name of the LDAP server. Only the administrator can set this value. Returns empty string on success, error message on failure.

---

---

### getPortNo

---

#### Declaration

```
int getPortNo()
```

#### Operation

Gets the port number of the server used for storage of user and group information.

---

---

### setPortNo

---

#### Declaration

```
string setPortNo(int portNo)
```

## Operation

Sets the port number of the server used for storage of user and group information. Only the administrator can set this value. Returns empty string on success, error message on failure.

## getDoorsBindNameDN

### Declaration

```
string getDoorsBindNameDN()
```

### Operation

Gets the dn of the user we use to bind to the LDAP server.

## setDoorsBindNameDN

### Declaration

```
string setDoorsBindNameDN(string name)
```

### Operation

Sets the dn of the user we use to bind to the LDAP server. Only the administrator can set this value.

Returns empty string on success, error message on failure.

## setDoorsBindPassword

### Declaration

```
string setDoorsBindPassword(string pass)
```

### Operation

Sets the password we use to bind to the LDAP server. Only the administrator can set this value.

Returns empty string on success, error message on failure.

**Note:** There is no `getDoorsBindPassword` as DXL does not need to know this.

## setDoorsBindPasswordDB

### Declaration

```
string setDoorsBindPasswordDB(DB parentWindow)
```

### Operation

This presents the user with a password dialog box. If the user enters the same valid password in both fields of the dialog box, the `setDoorsBindPassword()` functionality is executed.

This returns null on success, and an error string on failure (either if the user does not enter the same valid password in both fields of the dialog box, or if the setting of the password option failed).

---

## getDoorsUserRoot

---

### Declaration

```
string getDoorsUserRoot()
```

### Operation

Gets the identifier of the directory subtree used for storage of user information.

---

## setDoorsUserRoot

---

### Declaration

```
string setDoorsUserRoot(string ident)
```

### Operation

Sets the identifier of the directory subtree used to search the LDAP server for users. Only the administrator can set this value. Returns empty string on success, error message on failure.

---

## getDoorsGroupRoot

---

### Declaration

```
string getDoorsGroupRoot()
```

### Operation

Gets the identifier of the directory subtree used for storage of group information.

---

## setDoorsGroupRoot

---

### Declaration

```
string setDoorsGroupRoot(string ident)
```

### Operation

Sets the identifier of the directory subtree used to search the LDAP server for groups. Only the administrator can set this value. Returns empty string on success, error message on failure.

---

## getDoorsUserGroupDN

---

### Declaration

```
string getDoorsUserGroupDN()
```

### Operation

Gets the dn of the LDAP group used to specify permitted Rational DOORS users.

---

## setDoorsUserGroupDN

---

### Declaration

```
string setDoorsUserGroupDN(string dn)
```

### Operation

Sets the dn of the LDAP group used to specify permitted Rational DOORS users. Only the administrator can set this value. Returns empty string on success, error message on failure.

---

## getDoorsGroupGroupDN

---

### Declaration

```
string getDoorsGroupGroupDN()
```

### Operation

Gets the dn of the LDAP group used to specify permitted Rational DOORS groups.

---

## setDoorsGroupGroupDN

---

### Declaration

```
string setDoorsGroupGroupDN()
```

### Operation

Sets the dn of the LDAP group used to specify permitted Rational DOORS groups. Only the administrator can set this value. Returns empty string on success, error message on failure.

---

## LDAP data configuration

---

---

### getDoorsUsernameAttribute

---

#### Declaration

```
string getDoorsUsernameAttribute()
```

#### Operation

Gets the name of the LDAP attribute to be used for a Rational DOORS user name.

---

---

### setDoorsUsernameAttribute

---

#### Declaration

```
string setDoorsUsernameAttribute(string name)
```

#### Operation

Sets the name of the LDAP attribute to be used for a Rational DOORS user name. Only the administrator can set this value. Returns empty string on success, error message on failure.

---

---

### getLoginNameAttribute

---

#### Declaration

```
string getLoginNameAttribute()
```

#### Operation

Gets the name of the LDAP attribute to be used for the system login name.

---

---

### setLoginNameAttribute

---

#### Declaration

```
string setLoginNameAttribute(string name)
```

#### Operation

Sets the name of the LDAP attribute to be used for the system login name. Only the administrator can set this value. Returns empty string on success, error message on failure.

---

## getEmailAttribute

---

### Declaration

```
string getEmailAttribute()
```

### Operation

Gets the name of the LDAP attribute to be used for the user's email address.

---

## setEmailAttribute

---

### Declaration

```
string setEmailAttribute(string email)
```

### Operation

Sets the name of the LDAP attribute to be used for the user's email address. Only the administrator can set this value. Returns empty string on success, error message on failure.

---

## getDescriptionAttribute

---

### Declaration

```
string getDescriptionAttribute()
```

### Operation

Gets the name of the LDAP attribute to be used for the user's description.

---

## setDescriptionAttribute

---

### Declaration

```
string setDescriptionAttribute(string name)
```

### Operation

Sets the name of the LDAP attribute to be used for the user's description. Only the administrator can set this value. Returns empty string on success, error message on failure.

---

## getTelephoneAttribute

---

### Declaration

```
string getTelephoneAttribute()
```

## Operation

Gets the name of the LDAP attribute to be used for the users's telephone number.

---

## setTelephoneAttribute

---

### Declaration

```
string setTelephoneAttribute(string phone)
```

### Operation

Sets the name of the LDAP attribute to be used for the users's telephone number. Only the administrator can set this value. Returns empty string on success, error message on failure.

---

## getAddressAttribute

---

### Declaration

```
string getAddressAttribute()
```

### Operation

Gets the name of the LDAP attribute to be used for the users's address.

---

## setAddressAttribute

---

### Declaration

```
string setAddressAttribute(string address)
```

### Operation

Sets the name of the LDAP attribute to be used for the users's address. Only the administrator can set this value. Returns empty string on success, error message on failure.

---

## getGroupObjectClass

---

### Declaration

```
string getGroupObjectClass()
```

### Operation

Gets the name of the LDAP object class to be used to identify groups. Typically this value will be `groupOfUniqueNames`.



---

## setGroupObjectClass

---

### Declaration

```
string setGroupObjectClass(string class)
```

### Operation

Sets the name of the LDAP object class to be used to identify groups. Only the administrator can set this value. Returns empty string on success, error message on failure.

---

## getGroupMemberAttribute

---

### Declaration

```
string getGroupMemberAttribute()
```

### Operation

Gets the name of the LDAP attribute to be used to identify group members. Typically this value will be `uniqueMember`.

---

## setGroupMemberAttribute

---

### Declaration

```
string setGroupMemberAttribute(string name)
```

### Operation

Sets the name of the LDAP attribute to be used to identify group members. Only the administrator can set this value. Returns empty string on success, error message on failure.

---

## getGroupNameAttribute

---

### Declaration

```
string getGroupNameAttribute()
```

### Operation

Gets the name of the LDAP attribute to be used for a group's name. Typically this value will be `cn`.

---

## setGroupNameAttribute

---

### Declaration

```
string setGroupNameAttribute(string group)
```

## Operation

Sets the name of the LDAP attribute to be used for a group's name. Only the administrator can set this value. Returns empty string on success, error message on failure.

## Group and user properties

### Declaration

```
string ldapRDN
```

If we have a user `u`, `print u.ldapRDN` prints the user's LDAP relative distinguished name, which may be empty if LDAP is not being used.

The administrator can set a user's LDAP `rdn` with

```
u.ldapRDN = new value.
```

## string utf8(ansiString)

### Declaration

```
string utf8(string ansiString)
```

### Operation

This returns the UTF-8 format conversion of an ANSI string argument *ansiString*. LDAP servers use UTF-8 encoding, whereas Rational DOORS data is stored in ANSI format. This affects the encoding of extended characters, such as accented letters, which are encoded in UTF-8 as 2-byte sequences.

## string ansi(utf8String)

### Declaration

```
string ansi(string utf8String)
```

### Operation

This returns the ANSI format conversion of a UTF-8 string argument *utf8String*. LDAP servers use UTF-8 encoding, whereas Rational DOORS data is stored in ANSI format. This affects the encoding of extended characters, such as accented letters, which are encoded in UTF-8 as 2-byte sequences.

## Rational Directory Server

After using any of the following functions to modify the Rational Directory Server, use the `saveLdapConfig()` function to save the modifications.

---

## getUseTelelogicDirectory

---

### Declaration

```
bool getUseTelelogicDirectory()
```

### Operation

Returns a flag indicating whether Rational Directory Server support is enabled.

---

## setUseTelelogicDirectory

---

### Declaration

```
string setUseTelelogicDirectory(bool b)
```

### Operation

Enables or disables Rational Directory Server support.

Returns an error string if the current user is not the administrator.

Returns an error message if the argument is `true` and ordinary LDAP is already enabled.

---

## getTDServerName

---

### Declaration

```
string getTDServerName()
```

### Operation

Returns the Rational Directory Server name.

---

## setTDServerName

---

### Declaration

```
string setTDServerName(string s)
```

### Operation

Sets the Rational Directory Server name.

Returns an error string if the current user is not the administrator.

---

## getTDPortNo

---

### Declaration

```
int getTDPortNo()
```

### Operation

Returns the Rational Directory Server port number.

---

## setTDPortNo

---

### Declaration

```
string setTDPortNo(int i)
```

### Operation

Sets the Rational Directory Server port number.

Returns an error string if the current user is not the administrator.

---

## getTDBindName

---

### Declaration

```
string getTDBindName()
```

### Operation

Returns the Rational Directory Server administrator bind (login) name.

---

## setTDBindName

---

### Declaration

```
string setTDBindName(string s)
```

### Operation

Sets the Rational Directory Server administrator bind (login) name.

Returns an error string if the current user is not the administrator.

---

## setTDBindPassword

---

### Declaration

```
string setTDBindPassword(string s)
```

## Operation

Sets the Rational Directory Server administrator bind (login) password.

Returns an error string if the current user is not the administrator.

## setTDBindPassword

### Declaration

```
string setTDBindPassword(DB bind_pass)
```

### Operation

Sets the Rational Directory Server administrator bind (login) password from the specified database.

## getTDUseDirectoryPasswordPolicy

### Declaration

```
bool getTDUseDirectoryPasswordPolicy()
```

### Operation

Returns a flag indicating whether the directory should handle all password policy issues.

## setTDUseDirectoryPasswordPolicy

### Declaration

```
string setTDUseDirectoryPasswordPolicy(bool TD_dir)
```

### Operation

Enables or disables support for the directory password policy.

Returns an error string if the current user is not the administrator.

## getAdditionalAuthenticationEnabled

### Declaration

```
bool getAdditionalAuthenticationEnabled()
```

### Operation

Returns `true` if enhanced security users need to perform additional authentication during login. Only relevant when authentication is being controlled via RDS.

---

## getAdditionalAuthenticationPrompt

---

### Declaration

```
string getAdditionalAuthenticationPrompt()
```

### Operation

Returns the label under which additional authentication is requested, if enhanced security is enabled, for example the label for the second “password” field. Only relevant when authentication is being controlled via RDS.

---

## getSystemLoginConformityRequired

---

### Declaration

```
bool getSystemLoginConformityRequired()
```

### Operation

Returns `true` if enhanced security users have their system login verified when logging in. Only relevant when authentication is being controlled via RDS.

---

## getCommandLinePasswordDisabled

---

### Declaration

```
bool getCommandLinePasswordDisabled()
```

### Operation

Return `true` if the `-P` command line password argument is disabled by default.

---

## setCommandLinePasswordDisabled

---

### Declaration

```
string setCommandLinePasswordDisabled(bool)
```

### Operation

Sets whether the `-P` command line password argument is disabled by default. Supplying `true` disables the option by default.

## Chapter 15

# Rational DOORS hierarchy

This chapter describes features that are relevant to items, folders, and projects within the Rational DOORS hierarchy. Features specific to modules and objects are described in the following chapters:

- About the Rational DOORS hierarchy
- Item access controls
- Hierarchy clipboard
- Hierarchy information
- Hierarchy manipulation
- Items
- Folders
- Projects
- Looping within projects

---

## About the Rational DOORS hierarchy

Within a Rational DOORS database there are items, which can be **folders**, **projects**, and **modules**. A project is a special type of folder. The database root is also a folder.

In DXL, the Rational DOORS hierarchy is represented by the data types `Item`, `Folder`, `Project`, and a call to the `module` function. Open modules are also represented by the `Module` data type.

Functions that operate on items have equivalents for folders, projects and modules.

Modules and folders are in general referenced by their unqualified names (without paths). However, DXL scripts can specify fully qualified names, which are distinguished by the inclusion of one or more slash (/) characters. These names can be either relative to the current folder, for example:

```
../folder/module
```

or absolute (with a leading slash), for example:

```
/folder/module
```

Create functions fail if an invalid (non-existent) path is specified.

Functions common to all hierarchy items are described in “Hierarchy clipboard,” on page 267, “Hierarchy information,” on page 270, and “Hierarchy manipulation,” on page 274.

Functions specific to items of type `Item` are described in “Items,” on page 276.

Functions specific to folders are described in “Folders,” on page 279.

Functions specific to projects are described in “Projects,” on page 282.

Functions specific to modules are described in “Modules,” on page 289.

---

## Item access controls

This section describes functions that report on access rights for items.

---

### canCreate(item)

---

#### Declaration

```
bool canCreate({Item i|Folder f})
```

#### Operation

Returns `true` if the current Rational DOORS user has create access to the item or folder specified by the argument. Otherwise, returns `false`.

---

### canControl(item)

---

#### Declaration

```
bool canControl({Item i|Folder f})
```

#### Operation

Returns `true` if the current Rational DOORS user can change the access controls on the item or folder specified by the argument. Otherwise, returns `false`.

---

### canRead(item)

---

#### Declaration

```
bool canRead({Item i|Folder f})
```

#### Operation

Returns `true` if the current Rational DOORS user can read the item or folder specified by the argument. Otherwise, returns `false`.

---

### canModify(item)

---

#### Declaration

```
bool canModify({Item i|Folder f})
```



## Operation

Returns `true` if the current Rational DOORS user can modify the item or folder specified by the argument. Otherwise, returns `false`.

## canDelete(item)

### Declaration

```
bool canDelete({Item i|Folder f})
```

### Operation

Returns `true` if the current Rational DOORS user can delete the item or folder specified by the argument. Otherwise, returns `false`.

## Hierarchy clipboard

This section defines functions for the hierarchy clipboard. Passing a `null` argument of type `Item`, `Folder`, or `Project` to any function, or a `null` string to a call to the module function results in a run-time DXL error. The term `item` means a variable of type `Item`, type `Folder`, or type `Project`, or a call to the module function.

## clipCut

### Declaration

```
string clipCut(Item i)
```

### Operation

Places a write lock on the item specified by the argument, and adds it to the clipboard as part of a set of cut items. If the write lock fails, or if the user does not have delete access to the item and its descendants (if any), the call to `clipCut` fails.

If the previous operation was not a cut, this function first clears the clipboard. If the item is deleted, returns an error message.

No other user can open the cut item until it has been pasted or the cut has been undone.

## clipCopy

### Declaration

```
string clipCopy(Item i)
```

## Operation

Places a share lock on the item specified by the argument, and adds it to the clipboard as part of a set of copied items. If the share lock fails, or if the user does not have read access to the item, the call to `clipCopy` fails. Any descendants of the item to which the user does not have read access are not included as part of the set of items placed on the clipboard.

If the previous operation was a paste, this function first clears the clipboard. If the previous operation was a cut, this function first performs an undo. If the item is deleted, returns an error message.

No other user can move, delete or rename the item until it has been pasted or the copy has been undone.

## clipClear

### Declaration

```
string clipClear([bool force])
```

### Operation

If the last operation was not a cut, unlocks and clears the clipboard contents. If the last operation was a cut, the result depends on the value of *force* as follows:

<code>false</code>	the call fails
<code>true</code>	purges the contents of the clipboard from the database.

If you omit *force*, its value is assumed to be `false`.

## clipPaste

### Declaration

```
string clipPaste(Folder folderRef)
```

### Operation

Pastes the contents of the clipboard to *folderRef*. If the user does not have create access to the destination, the call to `clipPaste` fails. If *folderRef* is deleted, returns an error message.

If the previous operation was a cut, moves the contents of the clipboard from their original location, and places a share lock on them. Otherwise, unlocks the originals, and makes copies of them in *folderRef*. In this case, any projects have `Copy n of` in front of their names, because duplicate project names are not allowed. If this still results in duplicate names, `Copy n of` is used, where *n* is the lowest number  $\geq 2$  that prevents duplication. This function uses the same naming convention to avoid duplication when copying items into their original folder.

The items pasted from the clipboard remain share locked until the clipboard is cleared. This is done automatically when the client closes down, or when the user opens any module in the clipboard for exclusive edit, or deletes, renames, or moves any item in the clipboard.

---

## clipUndo

---

### Declaration

```
string clipUndo({Item i})
```

### Operation

If the last operation was a cut or copy, unlocks and clears the clipboard contents.

---

## clipLastOp

---

### Declaration

```
int clipLastOp()
```

### Operation

Returns an integer indicating the last operation performed on the hierarchy clipboard. The returned value can be of: Cut, Copy, Clear, Paste, Undo.

---

## itemClipboardIsEmpty

---

### Declaration

```
bool itemClipboardIsEmpty()
```

### Operation

If there are no items in the hierarchy clipboard, returns `true`; otherwise, returns `false`.

---

## inClipboard

---

### Declaration

```
bool inClipboard({Item i|Folder f|Project p|Module m|ModName_ modRef})
```

### Operation

If the item specified by the argument is in the hierarchy clipboard, returns `true`; otherwise, returns `false`.

---

## Hierarchy information

This section defines functions that provide information about items, folders, projects, or modules. The term *item* means a variable of type `Item`, type `Folder`, type `Project` or type `ModName_`. You can also reference an open module using the data type `Module`. Passing a null argument of type `Item`, `Folder`, `Project`, `Module` or `ModName_` to any function results in a run-time DXL error.

---

### folder, project, module(state)

---

#### Declaration

```
bool folder(string folderName)
bool project(string projectName)
bool module(string moduleName)
```

#### Operation

Returns `true` if the argument is the name of a folder, project, or module to which the current user has read access; otherwise, returns `false`.

Because a project is a special class of folder, the `folder` function returns `true` for projects as well as other folders.

---

### description

---

#### Declaration

```
string description({Item i|Folder f|Project p|Module m|ModName_ modRef})
```

#### Operation

Returns the description of the item specified by the argument.

#### Example

```
print description current Module
```

---

### name(item)

---

#### Declaration

```
string name({Item i|Folder f|Project p|Module m|ModName_ modRef})
```

#### Operation

Returns the unqualified name of the item specified by the argument.

#### Example

```
print name current Module
```

---

## fullName(item)

---

### Declaration

```
string fullName({Item i|Folder f|Project p|Module m|ModName_ modRef})
```

### Operation

Returns the full name of the item specified by the argument, including the path from the nearest ancestor project, or if not inside a project, from the root folder.

---

## path(item)

---

### Declaration

```
string path({Item i|Folder f|Project p|Module m|ModName_ modRef})
```

### Operation

Returns the full name of the parent of the item specified by the argument from the nearest ancestor project, or if not inside a project, from the root folder.

---

## getParentFolder(item)

---

### Declaration

```
Folder getParentFolder({Item i|Folder f|Project p|Module m|ModName_ modRef})
```

### Operation

Returns the folder containing the item specified by the argument. If the argument is the root folder, returns null.

---

## getParentProject(item)

---

### Declaration

```
Project getParentProject({Item i|Folder f|Project p|Module m|ModName_ modRef})
```

### Operation

Returns the nearest ancestor project for the item specified by the argument, or null if there is none. If the item is a project, this function does not return the project itself, but the nearest one above (or null if there is none).

---

## isDeleted(item)

---

### Declaration

```
bool isDeleted({Item i|Folder f|Project p|ModName_ modRef})
```

## Operation

If the item specified by the argument is marked as deleted or soft deleted, or if it does not exist, or if the user does not have read access to it, returns `true`; otherwise, returns `false`.

---

## setShowDeletedItems(bool)

---

### Declaration

```
void setShowDeletedItems (bool show)
```

### Operation

If bool `show` is set to `true`, deleted items will be visible in the Database Explorer. Setting `show` to `false` hides all deleted items.

---

## type

---

### Declaration

```
string type({Item i|Folder f|Module m|ModName_ modRef})
```

### Operation

Returns the type of the item specified by the argument as a string. Possible values are shown in the following table.

Return value	Item	Folder	Module
"Folder"	y	y	n
"Project"	y	y	n
"Formal"	y	n	y
"Link"	y	n	y
"Descriptive"	y	n	y

### Example

```
print type(item "/")
```

---

## uniqueID

---

### Declaration

```
string uniqueID({Item i|Folder f|Project p|ModName_ modRef|Module m})
```

## Operation

Returns a unique identifier for the specified item, which lasts for the lifetime of the item, and is never reused. The unique identifier does not change when the item is moved or renamed. If the item is copied, the copy has a different identifier.

A call to this function where *i* does not exist causes a DXL run-time error.

## qualifiedUniqueID

### Declaration

```
string qualifiedUniqueID({Item i|Folder f|Project p|ModName_ name|Module m})
```

### Operation

Returns a representation of a reference to the specified `Item`, `Folder`, `Project`, `Module` or `ModName_`, which uniquely identifies that object amongst databases.

Provided that supported mechanisms for the creation of Rational DOORS databases are used, these unique identifiers can be treated as globally unique; no two objects in any two databases will have the same `qualifiedUniqueID`.

See also `uniqueID`, which returns an unqualified representation of a reference.

## getReference

### Declaration

```
string getReference(Item referrer, Item referee)
```

### Operation

Returns a reference to the referee from the referrer. This reference is invariant under archive/restore (both inter-database and intra-database) and copy/paste. Such a reference is to be used in preference to the referee's index, unless the reference is intended to be variant under such operations.

## itemFromReference

### Declaration

```
Item itemFromReference(Item referrer, string ref)
```

### Operation

Returns the item to which *ref* refers from the specified referrer. *ref* must be a string that was obtained using the `getReference()` perm. If the reference cannot be resolved, the returned item will satisfy null.

### Example

Make a reference from the current module to an item named "a"

```
Item i = item fullName current Module
```

```
Item j = item "a"
```

```
// rj is a reference to j from i
string rj = getReference(i, j)

print rj "\n"
```

This reference will never change when *i* and *j* are moved, copied (together), archived, and restored (together).

Copy *i* and *j* to get *ii* and *jj*

```
Item j = itemFromReference(i, rj) // get item that rj refers
Item jj = itemFromReference(ii, rj) // get item that rj refers
```

Typically these would be used when generating traceability. The DXL that generates the layout DXL or attribute DXL would call `getReference` and then insert the returned value into the layout DXL or attribute DXL code as the value passed to `itemFromReference()`.

---

## Hierarchy manipulation

This section defines functions for item manipulation. All creation functions are specific to the type of item being created, but you can delete, undelete, purge, move, and rename items of all types using the Item handle. The term **item** means a variable of type `Item`, type `Folder`, type `Project` or type `ModName_`. You can also reference an open module using the data type `Module`. Passing a null argument of type `Item`, `Folder`, `Project`, `Module` or `ModName_` to any function results in a run-time DXL error.

---

### delete(item)

---

#### Declaration

```
string delete({Item i|Folder f|Project p})
string delete (ModName_ &modRef
              [,bool hardDelete])
bool delete (ModName_ &modRef)
```

#### Operation

Marks the item specified by the argument as deleted. If the item is already marked as deleted, or if the user does not have delete access to it, the call fails.

The first and second forms return a null string on success; otherwise, an error message.

In the second form, if `hardDelete` is set to `false`, the module is not purged. If `hardDelete` is `true` or missing and if the module was soft-deleted, the module is purged. If the module was not soft-deleted, the function returns an error message. If the operation succeeds and the module is purged, the function also sets the `ModName_` argument to `null`.



The third form is retained for compatibility with earlier releases. It returns `true` on success; otherwise, `false`. This is equivalent to `hardDelete(module)` (the module need not be soft deleted). If the operation succeeds, also sets the `ModName_` argument to `null`.

For a folder or project, the user must also have delete access to all the undeleted folders, projects, and modules in it.

---

## undelete(item)

---

### Declaration

```
string undelete({Item i|Folder f|Project p|ModName_ modRef})
bool undelete(ModName_ modRef)
```

### Operation

Marks the item specified by the argument as undeleted. If the item is not marked as deleted, or if the user does not have delete access to the item, the call fails.

The first form returns a null string on success; otherwise, an error message.

The second form is retained for compatibility with earlier releases. It returns `true` on success; otherwise, `false`.

For a folder or project, this function also marks as undeleted all folders, projects, and modules in it, to which the user has delete access.

### Example

```
undelete item "my folder"
```

---

## purge(item)

---

### Declaration

```
string purge({Item &i|Folder &f|Project &p|ModName_ &modRef})
bool purge(ModName_ &modRef)
```

### Operation

Purges the item specified by the argument from the database. If the operation succeeds, sets the argument to `null`. If the item is not marked as deleted, or if the user does not have delete access to the item, the call fails.

The first form returns a null string on success; otherwise, an error message.

The second form is retained for compatibility with earlier releases. It returns `true` on success; otherwise, `false`.

For a folder or project, the user must also have delete access to all the undeleted folders, projects, and modules in it.

For a `ModName_` argument, the function deletes all incoming and outgoing links before purging the module.

### Example

```
purge item "my folder"
or
```

```
Item i = item "my folder"
purge i
```

---

## move(item)

---

### Declaration

```
string move({Item i|Folder f|Project p|ModName_ modRef}, Folder destination)
```

### Operation

Moves the item specified by the first argument to folder *destination*. The folder can be any folder except the database root.

If the user does not have delete access to the item, or create access to the destination folder, the call fails.

If the operation succeeds, returns a null string; otherwise, returns a string describing the error.

### Example

```
move(item "My Module", folder "/new projects")
```

---

## rename(item)

---

### Declaration

```
string rename({Item i|Folder f|Project
              p|ModName_ modRef},
              string name,
              string description)
```

```
bool rename(ModName_ modRef)
```

### Operation

Renames the item specified by the first argument to *name* and associates it with *description*. The name argument must be an unqualified name. If the user does not have modify access to the item, the call fails.

The first form returns a null string on success; otherwise, an error message.

The second form is retained for compatibility with earlier releases. It returns `true` on success; otherwise, `false`.

### Example

```
rename(folder "my folder", "public", "for review")
```

---

## Items

This section defines functions and for loops for items, which make use of the `Item` data type. Passing a null argument of type `Item` to any function results in a run-time DXL error.

See also the functions in “Hierarchy clipboard,” on page 267, “Hierarchy information,” on page 270, and “Hierarchy manipulation,” on page 274.

---

## item(handle)

---

### Declaration

```
Item item(string itemName)
```

### Operation

If *itemName* is the name of an item to which the current user has read access, returns a handle of type *Item*; otherwise, returns *null*.

---

## itemFromID(handle)

---

### Declaration

```
Item itemFromID(string uniqueID)
```

### Operation

If *uniqueID* is the ID of an item to which the current user has read access, returns a handle of type *Item*; otherwise, returns *null*.

---

## for item in folder

---

### Syntax

```
for itemRef in folder do {
  ...
}
```

where:

<i>itemRef</i>	is a variable of type <i>Item</i>
<i>folder</i>	is a variable of type <i>Folder</i>

### Operation

Assigns *itemRef* to be each successive undeleted item (for which the user has read access) in *folder*. Items in sub-folders are not included.

### Example

```
Item i
for i in current Folder do {
  print (name i) "\n"
}
```

---

## for all items in folder

---

### Syntax

```
for itemRef in all folder do {
  ...
}
```

where:

*itemRef* is a variable of type Item  
*folder* is a variable of type Folder

### Operation

Assigns *itemRef* to be each successive item (for which the user has read access) in *folder*, including deleted items. Items in sub-folders are not included.

### Example

```
Folder f = current
Item itemRef

for itemRef in f do {
    print fullName(itemRef) "\n"
}
```

---

## for all items in project

---

### Syntax

```
for itemRef in project do {
  ...
}
```

where:

*itemRef* is a variable of type Item  
*project* is a variable of type Project

### Operation

Assigns *itemRef* to be each successive undeleted item (for which the user has read access) in *project*, looping recursively through contained folders and projects.

## Example

```
Item itemRef
for itemRef in current Project do
    print name(itemRef) "\n"
```

---

## Folders

This section defines functions for folders.

See also the functions in “Hierarchy clipboard,” on page 267, “Hierarchy information,” on page 270, and “Hierarchy manipulation,” on page 274.

---

### Setting current folder

---

The assignment operator = can be used as shown in the following syntax:

```
current = Folder folder
```

Makes *folder* the current folder, provided the user has read access to the folder. See also, the `current(folder)` function.

To set the current folder to the database root, use:

```
current = folder "/"
```

For large DXL programs, when you set the current folder, cast the current on the left hand side of the assignment to the correct type. This speeds up the parsing of the DXL program, so when your program is first run, it is loaded into memory quicker. It does not affect the subsequent execution of your program. So:

```
current = newCurrentFolder
```

becomes

```
(current FolderRef__) = newCurrentFolder
```

Note that this cast only works for assignments to current. It is not useful for comparisons or getting the value of the current folder.

---

### current(folder)

---

#### Declaration

```
Folder current()
```

#### Operation

Returns a handle on the current folder.

The current folder can be a project.

The current folder has two important implications:

- When you specify an item name, it is interpreted relative to the current folder.
- When you set the current folder using the assignment operator, you lock that folder and its ancestors, so that it cannot be renamed, deleted or moved.

The project or folder that is opened in the Database Explorer is similarly locked. If you open a DXL window or run another DXL script, that has its own current folder. The current folder for the DXL window is initially the current folder of its parent.

If all folders are closed, the database root becomes the current folder.

### Example

```
Folder f = current
```

## folder(handle)

### Declaration

```
Folder folder(string folderName)
Folder folder(Item itemRef)
```

### Operation

If the argument specifies a folder to which the current user has read access, returns a handle of type `Folder`; otherwise, returns `null`.

The string `"/` identifies the database root.

### Example

This example sets the current folder to the database root:

```
current = folder "/"
```

## convertProjectToFolder

### Declaration

```
string convertProjectToFolder(Project projectRef, Folder &folderRef)
```

### Operation

Converts the project *projectRef* to a folder *folderRef*. If the operation succeeds, sets *projectRef* to `null`, makes the folder argument valid, and returns a null string; otherwise, returns an error message. If the user does not have control access to the project or the create projects power (through `mayCreateTopLevelFolders`), the call fails.

### Example

```
Project p = project "/Construction Project"
Folder f
string s = convertProjectToFolder(p, f)
```

```

if (null s)
    print "Converted project " name(f) "to folder."
else
    print "Error: " s

```

---

## convertFolderToProject

---

### Declaration

```

string
convertFolderToProject(Folder folderRef,
                      Project &projectRef)

```

### Operation

Converts the folder *folderRef* to a project *projectRef*. If the operation succeeds, sets *folderRef* to null, makes the project argument valid, and returns a null string; otherwise, returns an error message. If the user does not have control access to the folder or the create projects power (through `mayCreateTopLevelFolders`), the call fails.

### Example

```

Folder f = folder "/Construction Project/test records"
Project p
string s = convertFolderToProject(f, p)
if (null s)
    print "Converted folder " name(p) "to project."
else
    print "Error: " s

```

---

## create(folder)

---

### Declaration

```

Folder create(string name,
             string description)
string create(string name, description desc, Folder& f)

```

### Operation

Creates a folder with the given *name* and *description*. The *name* argument can be an absolute or relative name, and may include the path. If the user does not have create access to the parent folder, the call fails.

The second form of the perm performs the same function as the first, but returns any error message, and passes the created folder back via the last argument.

---

## closeFolder

---

### Declaration

```
string closeFolder()
```

### Operation

Changes the current folder to refer to the parent of the current folder. If the operation succeeds returns a null string; otherwise, returns a string describing the error.

### Example

```
closeFolder()
```

---

## Projects

This section defines operators, functions and for loops for projects, which make use of the `Project` data type. Passing a null argument of type `Project` to any function results in a run-time DXL error.

See also the functions in “Hierarchy clipboard,” on page 267, “Hierarchy information,” on page 270, and “Hierarchy manipulation,” on page 274.

---

## Setting current project

---

The assignment operator `=` can be used as shown in the following syntax:

```
current = Project project
```

Makes *project* the current folder, and the current project, provided the user has read access to the folder. See also, the `current(project)` function.

If the current folder is a project, it is also the current project. If the current folder is not a project, the current project is the nearest project containing the current folder. If the current folder is not contained in a project, the current project is null.

For large DXL programs, when you set the current project, cast the current on the left hand side of the assignment to the correct type. This speeds up the parsing of the DXL program, so when your program is first run, it is loaded into memory quicker. It does not affect the subsequent execution of your program. So:

```
current = newCurrentProject
```

becomes

```
(current FolderRef__) = newCurrentProject
```

Note that this cast only works for assignments to `current`. It is not useful for comparisons or getting the value of the current project.

### Example

```
current = project "/My Project"
```



---

## current(project)

---

### Declaration

```
Project current()
```

### Operation

Returns a handle on the nearest ancestor project of the current folder, or null if the current folder is not in any project.

### Example

```
Module m
// check project is open
if (null current Project) {
    ack "No project is open"
    halt
}
for m in current Project do {
    print "Module " m."Name" " is open"
}
```

---

## project(handle)

---

### Declaration

```
Project project(string projectName)
```

```
Project project(Item itemRef)
```

### Operation

If the argument specifies a project to which the current user has read access, returns a handle of type Project to the project; otherwise, returns null.

---

## for project in database

---

### Syntax

```
for project in database do {
    ...
}
```

where:

*project* is a variable of type Project

## Operation

Assigns *project* to be each successive project (for which the user has read access) in the database, excluding deleted projects. Compare with `for all projects in database`.

## Example

This example prints a list of projects in the database:

```
Project p
for p in database do {
    print(name p) "\n"
}
```

## for all projects in database

### Syntax

```
for name in database do {
    ...
}
```

where:

*name* is a string variable

### Operation

Assigns the string *name* to be each successive project name (for which the user has read access) in the database, including deleted projects. Compare with `for project in database`.

### Example

This example prints a list of projects in the database:

```
string s
for s in database do {
    print s "\n"
}
```

## getInvalidCharInProjectName

### Declaration

```
char getInvalidCharInProjectName(string s)
```

### Operation

Returns any character in string *s* that would be invalid in a project name.

---

## isDeleted(project name)

---

### Declaration

```
bool isDeleted(string projectName)
```

### Operation

If *projectName* is a project that has been deleted but not purged, or if it does not exist, or if the user does not have read access to it, returns `true`; otherwise, returns `false`.

This function is retained only for compatibility with earlier releases. New programs should use the `isDeleted(item)` function.

### Example

```
Project p = project "Test Project"
if (!null p && !isDeleted p)
    current = p
```

---

## isValidName

---

See “`isValidName`,” on page 296.

---

## create(Project)

---

### Declaration

```
Project create(string projName,
               string description
               [,string adminUser
               [,string password,
               string loginsystem,
               int passwordPolicy,
               int adminPolicy,
               string &message]])
```

```
string create(string name, description desc, Project& p)
```

### Operation

Creates a project, *projName*, having *description*. The *adminUser* and following arguments are retained for compatibility with earlier releases; in Rational DOORS 6.0, the values of these arguments are ignored. However, a call to `create` that uses any of the legacy arguments sets the current folder to the new project (for compatibility with legacy DXL scripts, which expect the new project to be opened).

You must assign this function to a variable of type `Project`, otherwise, it tries to create a linkset between modules *projName* and *description*.

Administrator power is required for this function.

The second form of the `perm` performs the same function as the original `perm`, but returns any error message, and passes the created project back via the last argument.

### Example

```
Project p = create("Test Project", "Play area for
                  DOORS")
```

## closeProject

### Declaration

```
void closeProject()
```

### Operation

Sets the parent of the current project to be the new current folder. In Rational DOORS 6.0, closing a project means changing the current folder.

### Example

```
closeProject()
```

## openProject

### Declaration

```
string openProject(string projName
                  [,string user,
                  string pass])
```

### Operation

Sets the named project as the current folder. The *user* and *password* arguments are retained for compatibility with earlier releases. In Rational DOORS 6.0 these arguments are ignored.

If the project opens successfully, returns `null`; otherwise returns an error message. If the project does not exist, or the user does not have read access to it, the call fails.

### Example

```
string mess = openProject("Demo", "Catrina Magali", "aneblr")
```

## doorsVersion

### Declaration

```
string doorsVersion()
```

### Operation

Returns the version of the current Rational DOORS executable as a string.

## Example

```
print doorsVersion
```

---

## Looping within projects

The following sections describe the **for** loops available for looping within projects:

- for all items in project
- for open module in project
- for all modules in project
- for in-partition in project
- for out-partition in project
- for partition definition in project
- for trigger in project



## Chapter 16

# Modules

This chapter describes features that operate on Rational DOORS modules:

- Module access controls
- Module references
- Module information
- Module manipulation
- Module display state
- Baselines
- Baseline Set Definition
- Baseline Sets
- History
- Descriptive modules
- Recently opened modules
- Module Properties

---

## Module access controls

This section describes functions that report on access rights for a module. The module has to be open in exclusive edit mode.

---

### canCreate(module)

---

#### Declaration

```
bool canCreate(Module m)
```

#### Operation

Returns `true` if the current Rational DOORS user has create access to module *m*; otherwise, returns `false`.

---

### canControl(module)

---

#### Declaration

```
bool canControl(Module m)
```

## Operation

Returns `true` if the current Rational DOORS user can change the access controls on module *m*; otherwise, returns `false`.

## canModify(module)

### Declaration

```
bool canModify(Module m)
```

### Operation

Returns `true` if the current Rational DOORS user can modify module *m*; otherwise, returns `false`.

## canDelete(module)

### Declaration

```
bool canDelete(Module m)
```

### Operation

Returns `true` if the current Rational DOORS user can delete module *m*; otherwise, returns `false`.

## Module references

This section defines functions and for loops that make use of the `Module` data type.

See also the functions in “Hierarchy clipboard,” on page 267.

## Setting current module

The assignment operator `=` can be used as shown in the following syntax:

```
current = Module module
```

Makes *module* the current module. See also, the `current(module)` function.

For large DXL programs, when you set the current module, cast the current on the left hand side of the assignment to the correct type. This speeds up the parsing of the DXL program, so when your program is first run, it is loaded into memory quicker. It does not affect the subsequent execution of your program. So:

```
current = newCurrentModule
```

becomes

```
(current ModuleRef__) = newCurrentModule
```



Note that this cast only works for assignments to `current`. It is not useful for comparisons or getting the value of the current module.

---

## current(module)

---

### Declaration

```
Module current()
```

### Operation

Returns a reference to the current module. In some contexts `current` could be ambiguous, in which case it should be followed by `Module` in a cast.

### Example

```
print (current Module)."Description" "\n"
```

---

## module(handle)

---

### Declaration

```
Module module(Item itemRef)
```

```
ModName_ module(string modRef)
```

### Operation

The first form returns a handle of type `Module` for `itemRef` if `itemRef` is an open module. Otherwise, it returns `null`.

The second form returns a handle of type `ModName_` for the named module, whether it is open or closed.

---

## for module in database

---

### Syntax

```
for m in database do {
  ...
}
```

where:

`m` is a variable of type `Module`

### Operation

Assigns the variable `m` to be each successive open module (for which the user has read access) in the database.

---

## for open module in project

---

### Syntax

```
for m in project do {
  ...
}
```

where:

*m* is a variable of type Module  
*project* is a variable of type Project

### Operation

Assigns the variable *m* to be each successive open module (for which the user has read access) in *project*. This loop includes modules in sub folders as well as those in the top level of the project. It does not include modules in projects that are contained in the project. This only works on the user's computer.

### Example

```
Module m
int count = 0
for m in current Project do {
  print m."Name" "\n"
  count++
}
if (count==0)
  print "no modules in current project\n"
```

---

## for all modules in project

---

### Syntax

```
for moduleName in project do {
  ...
}
```

where:

*moduleName* is a string variable  
*project* is a variable of type Project

## Operation

Assigns the variable *moduleName* to be each successive module name (for which the user has read access) in *project*. This loop includes open or closed modules but only at the top level of the project. This is no longer everything contained in the project. This only works on the user's computer.

## Example

```
string modName
for modName in current Project do
    print modName "\n"
```

## for Module in Folder do

### Syntax

```
for m in folder do {
    ...
}
```

where:

*m* is a variable of type Module

*folder* is a variable of type Folder

### Operation

This provides access to all open modules that have the specified folder as their parent.

### Example

```
Module m
Folder f = current
for m in f do {
    print "Module " (name m) " is open "\n"
}
```

## Module information

This section defines functions that return information about Rational DOORS modules.

See also the functions in “Hierarchy information,” on page 270.

---

## Module state

---

### Declaration

```
bool baseline (Module m)
bool exists (ModName_ modRef)
bool open (ModName_ modRef)
bool unsaved (Module m)
```

### Operation

Each function returns true for a condition defined by the function name as follows:

Function	Returns true if
baseline	module <i>m</i> is a baseline; otherwise, returns false
exists	module <i>modRef</i> exists in the current project; otherwise, returns false
open	module <i>modRef</i> is open in any mode; otherwise, returns false
unsaved	module <i>m</i> has not been saved since changes were made; otherwise returns false

---

### Example

```
string s = "/proj1/SRD"
Item i = item s
if (exists module s) print "and the system requirements ... \n"
if (open module s) print "SRD is open\n"
```

---

## version

---

### Declaration

```
string version (Module m)
```

### Operation

Returns the version of open module *m* as a string.

### Example

```
print (version current Module)
```

---

## canRead, canWrite(module)

---

### Declaration

```
bool canRead(Module m)
bool canWrite(Module m)
```

### Operation

Returns whether the current Rational DOORS user has read or write access to the top of open module *m*.

---

## getSelectedCol

---

### Declaration

```
int getSelectedCol(Module m)
```

### Operation

Returns the integer identifier for the currently selected column in *m*. If the specified module is not displayed, or no column is selected, returns -1.

---

## isRead, isEdit, isShare

---

### Declaration

```
bool isRead(Module m)
bool isEdit(Module m)
bool isShare(Module m)
```

### Operation

Returns whether module *m* is open for reading, for editing or in shared mode. Otherwise, returns `false`.

These functions only return values for modules opened by the current user in the current session.

### Example

```
Module m
for m in current Project do {
    if (isEdit m)
        print m."Name" " is open edit\n"
}
```

---

## getInvalidCharInModuleName

---

### Declaration

```
char getInvalidCharInModuleName(string s)
```

### Operation

Returns any character in string *s* that would be invalid in a module name.

---

## isValidDescription

---

### Declaration

```
bool isValidDescription(string descString)
```

### Operation

Returns `true` if *descString* is a legal description for a project, module, view or page layout; otherwise, returns `false`.

### Example

This example returns `true`.

```
bool b = isValidDescription("Test Description")
```

---

## isValidName

---

### Declaration

```
{char|bool} isValidName(string nameString)
```

### Operation

By default, returns the first illegal character of *nameString*. If you force a type `bool`, returns `true` if *nameString* is a legal name for a project, module, view or page layout; otherwise, returns `false`.

### Example

This example returns `&`, the first illegal character in the name:

```
char c = isValidName("illegal&Name")
```

This example returns `true`:

```
char c = isValidName("legalName")
```

---

## isValidPrefix

---

### Declaration

```
bool isValidPrefix(string prefixString)
```

## Operation

Returns `true` if *prefixString* is a legal prefix for an object; otherwise returns `false`.

## Example

This example returns `true`:

```
bool b = isValidPrefix("PREFIX-1")
```

## isVisible

### Declaration

```
bool isVisible(Module m)
```

### Operation

Returns `true` if module *m* is open for display on the screen. Otherwise, returns `false`.

## Module manipulation

This section defines the functions for creating modules and performing database administration tasks on modules other than descriptive modules, which are covered in “Descriptive modules,” on page 341.

See also the functions in “Hierarchy manipulation,” on page 274.

## create(formal module)

### Declaration

```
Module create(string name,
              string desc,
              string prefix,
              int absno
              [,bool display])
```

```
string create(string name, description desc, prefix pref, int absnum, Module& m)
```

### Operation

Creates a formal module with name *name*, description *desc*, object prefix *prefix* and starting absolute number *absno*. The *name* argument can be an absolute or relative path. The optional last argument controls whether the module is displayed in the user interface after it has been created.

The second form creates a formal module. However, in the case of an error which causes no module to be created, the error message is returned instead of generating a run-time DXL error.

---

## create(descriptive module)

---

### Declaration

```
string create(string name, description desc, prefix pref, int absnum, string
filename, Module& m)
```

### Operation

Creates a Descriptive module. When an error occurs, which causes no module to be created, the error message is returned instead of generating a run-time DXL error.

---

## create(link module)

---

### Declaration

```
Module create(string name,
              string desc,
              int mapping
              [,bool display])
```

```
string create(string name, description desc, int mapping, Module& m)
```

```
const int manyToMany
```

```
const int manyToOne
```

```
const int oneToMany
```

```
const int oneToOne
```

### Operation

Creates a link module with name *name*, description *desc*, and a mapping. The *name* argument can be an absolute or relative path. The *mapping* argument can take one of the following values: `manyToMany`, `manyToOne`, `oneToMany` or `oneToOne`. As with the creation of a formal module, the optional last argument controls whether the module is displayed in the user interface after it has been created.

The second form of the perm creates a Link module, similar to the perm `Module create(name, description, mapping)`, but returns error messages instead of generating a run-time DXL error.

---

## close(module)

---

### Declaration

```
bool close(Module m
           [,bool save])
```

### Operation

Closes the open module *m*, with the option of saving changes. If *save* is `true`, the user is prompted to save before closing. If *save* is `false`, closes the module without saving. If the module is closed, the call fails.



If the operation fails, returns `false`. If `m` is a link module, `close` only succeeds if there are no loaded linksets and no other module is currently referring to the link module. Any open link modules that `m` refers to are also closed.

The Rational DOORS object clipboard is cleared when a module is closed.

Do not access the module handle after the module has been closed.

## downgrade

### Declaration

```
bool downgrade (Module m)
```

### Operation

Sets the open mode for module `m` to read only, if it is open in edit or shareable mode. This enables other users to open it in shared mode, or one at a time in exclusive edit mode. If the operation succeeds, returns `true`; otherwise, returns `false`. If the module is closed, the call fails. If there are unsaved changes to the module, then the user is prompted to save the changes. Alternatively, the `save perm` can be used prior to `downgrade`, so that any changes to the module are preserved.

This function is not equivalent to checking whether the current user can modify the given object.

## downgradeShare

### Declaration

```
bool downgradeShare (Module m)
```

### Operation

Sets the open mode for module `m` to shareable, if it is open in edit mode. This enables other users to open it in shared mode or read mode. If the operation succeeds, returns `true`; otherwise, returns `false`. If the module is closed, the call fails. If there are unsaved changes to the module, then the user is prompted to save the changes. Alternatively, the `save perm` can be used prior to `downgrade`, so that any changes to the module are preserved.

This function is not equivalent to checking whether the current user can modify the given object.

## printModule

### Declaration

```
void printModule (Module m)
```

### Operation

Opens the print dialog box for the open module `m`.

### Example

```
printModule current Module
```

---

## read, edit, share(open module)

---

### Declaration

```
Module read(string name
             [,bool disp[, bool loadStandardView]])
Module edit(string name
            [,bool disp[, bool silent[, bool loadStandardView]])
Module share(string name
             [,bool disp[, bool silent[, bool loadStandardView]])
```

### Operation

These functions return a module handle for the module named *name*. The name argument can be an absolute or relative path. The `read` function opens the module for reading, `edit` for unshared editing, and `share` for shared editing. The optional *disp* flag enables the visibility of the opened module to be specified; the module is displayed in a window if *disp* is true or omitted.

The optional parameter *silent* specifies whether the user should be prompted when the module cannot be opened in the desired mode because of locks. If this parameter is not supplied it is assumed to be false.

Using the optional parameter *loadStandardView* means you can force the standard view to be loaded as the default. If this parameter is not supplied it is assumed to be false.

**Note:** If a module is open in a particular mode, that same module must not be opened in another mode, if the statement doing this is within a `for` loop.

### Example

```
Module m = edit("/Car/Car user reqts", false)
```

---

## save(module)

---

### Declaration

```
void save(Module m)
```

### Operation

Saves open module *m*.

---

## copy(module)

---

### Declaration

```
bool copy(ModName_ modRef,
          string newName,
          string newDesc)
```

## Operation

Copies module *modRef* to new name *newName*, with description *newDesc*, within the same folder or project. All outgoing links are copied, but incoming links are not copied, and linksets are not updated.

## hardDelete(module)

### Declaration

```
bool hardDelete (ModName_ &modRef)
```

### Operation

Removes module *modRef* from the database (compare with the `softDelete (module)` function); the module cannot be recovered with `undelete (item)` following this operation.

If the operation succeeds, sets the argument to `null`, and returns `true`; otherwise, returns `false`. If the user does not have delete access to the item, or if the module is open, the call fails.

The function `hardDelete` should be used instead of the `delete (item)` function, for all new programs.

**Note:** `softDelete` must be used on a module before using `hardDelete`.

## softDelete(module)

### Declaration

```
bool softDelete (ModName_ modRef)
```

### Operation

Marks module *modRef* as deleted. The module is not actually deleted until it is purged. Modules marked for deletion can be recovered using the `undelete (item)` function.

When used interactively, a user who tries to use this function on a module with links has to confirm or cancel the operation. In batch mode no confirmation is required.

## formalStatus

### Declaration

```
void formalStatus (Module, String status)
```

### Operation

Displays the supplied string in the third area of the status bar in the specified module, which must be a formal module. If the module is not a formal module a DXL run-time error is generated.

---

## autoIndent

---

### Declaration

```
bool autoIndent (Module)
void autoIndent (bool)
```

### Operation

The first form returns true if auto-indentation for the main column in the specified module is currently turned on, otherwise it returns false.

The second form sets the auto-indentation status of the current module. The current module should be a formal module, otherwise a run-time DXL error will occur.

### Example

```
print autoIndent current
```

---

## Module display state

This section defines functions for getting and setting the display attributes of Rational DOORS modules.

---

### level(module get)

---

#### Declaration

```
int level (Module m)
```

#### Operation

Returns the display level of module *m*, which is between 0 (all levels) and 10.

---

### level(module set)

---

#### Declaration

```
void level (int i)
```

#### Operation

Sets the display level of the current module. Argument *i* must be between 0 (all levels) and 10.

---

## Get display state

---

### Declaration

```
bool filtering (Module m)
bool graphics (Module m)
bool outlining (Module m)
bool showPictures (Module m)
bool showTables (Module m)
bool sorting (Module m)
```

### Operation

Returns the current display state of attributes in open module *m*: graphics, filtering, outlining, visibility of pictures, visibility of tables, or sorting.

### Example

```
Module m = current
int  storeLevel      = level m
bool storeGraphics   = graphics m
bool storeFiltering  = filtering m
bool storeOutlining  = outlining m
bool storeSorting    = sorting m
functionThatChangesDisplay
// now restore old settings
level storeLevel
graphics storeGraphics
filtering storeFiltering
outlining storeOutlining
sorting storeSorting
if (showTables current) {
    print "table contents are visible"
}
if (!showPictures current) {
    ack "Pictures are not visible"
}
```

---

## Set display state

---

### Declaration

```
void filtering(bool onOff)
void graphics(bool onOff)
void linksVisible(bool onOff)
void outlin{e|ing}(bool onOff)
void showPictures(bool onOff)
void showTables(bool onOff)
void sorting(bool onOff)
```

### Operation

Turns on or off in the current module the attributes: filtering, graphics, visibility of links, outlining, visibility of pictures, visibility of tables and sorting.

### Example

```
graphics on
graphics true
graphics off
showPictures true
showTables false
```

---

## refresh

---

### Declaration

```
void refresh(Module m)
```

### Operation

Refreshes the display for open module *m*. Rational DOORS refreshes the current module after the termination of a DXL script. However, scripts that change the displays of other modules, or that create dialog boxes, need to manage display updates explicitly with this function.

---

## bringToFront

---

### Declaration

```
string bringToFront([Module])
```

## Operation

If a module is supplied it will bring that module window to the front of other windows. If a module is not supplied it will bring the Database Explorer window to the front. Note that this will not bring windows to the front of modal dialogs.

---

## Baselines

This section defines functions that operate on Rational DOORS formal module baselines. The file:

```
$DOORSHOME/lib/dxl/Example/baseline.dxl
```

contains a baseline comparison program, which uses the functions described in this section.

Many of the functions use the data type `Baseline`.

**Note:** When retrieving information, e.g. annotation, from a baseline you must use them within a `for baseline in module loop`.

---

### baseline

---

#### Declaration

```
Baseline baseline(int major,
                  int minor,
                  string suffix)
```

#### Operation

Returns a baseline handle for the combination of the specified *major* and *minor* version numbers and *suffix* string. If the baseline does not have a suffix, use `null`. This is only used to get a baseline handle for use in the baseline load perm. It cannot be used to retrieve information about that baseline, for example annotation information.

#### Example

```
Baseline b = baseline(1,0,"alpha")
```

---

### baselineExists

---

#### Declaration

```
bool baselineExists(Module m,
                    Baseline b)
```

#### Operation

Returns `true` when baseline *b* exists in module *m*; otherwise returns `false`.

#### Example

```
print baselineExists(current Module, b)
```

---

## create(baseline)

---

### Declaration

```
void create([Module m,]
           Baseline b,
           string annot)
```

### Operation

Creates a baseline for module *m* as specified by baseline handle *b* and annotation string *annot*. If the first argument is omitted, it uses the current module.

When this function is used to create a baseline, the module where the baseline is being created will be closed.

Use the `nextMajor`, `nextMinor` functions to instantiate the baseline handle.

---

## delete(baseline)

---

### Declaration

```
void delete([Module m,]
           Baseline b)
```

### Operation

This enables deletion of baselines in formal modules. The first argument defaults to the current module.

### Example

```
Baseline b = baseline(0, 1, "")
if (baselineExists(current Module, b)) delete(b)
```

---

## Get baseline data

---

### Declaration

```
int major(Baseline b)
int minor(Baseline b)
string suffix(Baseline b)
string annotation(Baseline b)
string user(Baseline b)
Date dateOf(Baseline b)
```

### Operation

These functions return the various data fields associated with baseline *b*. All these functions are included in the “Baselines example program,” on page 309. They must be used within a `for baseline in module` loop.



---

## getMostRecentBaseline

---

### Declaration

```
Baseline
getMostRecentBaseline(Module m
                      [,bool lastbaseline])
```

### Operation

Returns the last baseline. If *lastbaseline* is set to `true`, it returns the version number of the last baseline even if it has been deleted. Otherwise, it returns the last baseline that still exists.

### Example

```
Module m = current
Baseline b = getMostRecentBaseline(m)
print(major b) "." (minor b) (suffix b) "
      "(annotation b) "\n"
```

---

## getInvalidCharInSuffix

---

### Declaration

```
char getInvalidCharInSuffix(string s)
```

### Operation

Returns any character in string *s* that would be invalid in a baseline suffix.

---

## load

---

### Declaration

```
Module load([Module m,]
            Baseline b,
            bool display)
```

### Operation

Loads baseline *b* of module *m*; and if the last argument is `on` or `true`, displays it. If the first argument is omitted, it uses the current module.

### Example

This example loads baseline 1.0 (without a suffix) of the current module, without displaying it.

```
load(baseline(1,0,null), false)
```

---

## nextMajor, nextMinor

---

### Declaration

```
Baseline nextMajor([string suffix])
```

```
Baseline nextMinor([string suffix])
```

### Operation

Returns the next major or minor baseline, with or without a suffix.

### Example

```
create(nextMajor, "alpha review")
create(nextMajor "A", "alpha review")
```

---

## suffix

---

### Declaration

```
Baseline suffix(string suffix)
```

### Operation

Returns a new suffix version of the last baseline.

Can be used to baseline handle for the current version of a module.

### Example

```
create(suffix "AA", "no annotation")
```

---

## for baseline in module

---

### Syntax

```
for b in module do {
  ...
}
```

where:

*b* is a variable of type `Baseline`

*module* is a variable of type `Module`

### Operation

Assigns the baseline *b* to be each successive baseline found for module *module*.

## Example

```
Baseline b
for b in current Module do {
    print (major b) "." (minor b) (suffix b) "
        \t"
    print (user b) "\t " (dateOf b) "\n"
        (annotation b) "\n"
}
```

---

## Baselines example program

---

```
// baseline DXL Example
/*
  Example of baseline DXL
*/
Baseline b
Module old = current
for b in current Module do {
    print(major b) "." (minor b) (suffix b) "
        "(annotation b) "\n"
    load(b, true)
    break          // just load first one
}
current = old     // reset
if (confirm "create example baseline?") {
    create(nextMajor, "annotation helps explain
        project history")
    // current Module is closed by create.
}
```

---

## module(handle)

---

### Declaration

```
ModName_ module(ModuleVersion modver)
```

### Operation

This returns a handle of type `ModName_` for the given `ModuleVersion modver`. This gives access to information like name, description, etc. It returns null if the `ModuleVersion` does not reference an existing module to which the user has read access.

---

## data(for ModuleVersion)

---

### Declaration

```
Module data(ModuleVersion modver)
```

### Operation

This returns the data for the given `ModuleVersion` if the user has it open, loaded into memory. Otherwise, it returns null.

---

## load(ModuleVersion)

---

### Declaration

```
Module load(ModuleVersion modver, bool display)
```

### Operation

This loads the data (read-only mode) for the given `ModuleVersion`, if it references a current version or baseline to which the user has read access. If the `display` argument is `true`, then the baseline will be displayed. The perm returns the data on success, and null on failure. If the `ModuleVersion` argument is null, the perm will return null.

---

## moduleVersion(handle)

---

### Declaration

```
ModuleVersion moduleVersion(Module m)
```

```
ModuleVersion moduleVersion(ModName_ modRef[,Baseline b])
```

```
ModuleVersion moduleVersion(string index [,Baseline b])
```

### Operation

The first form returns the `ModuleVersion` reference for the given module version. The module version must be open.

The second form returns the `ModuleVersion` reference for the given `ModName_`/`Baseline` combination. The reference is to the current version of the module if the `Baseline` argument is omitted.

The third form returns the `ModuleVersion` reference for the given `index`/`Baseline` combination. The reference is to the current version if the `Baseline` argument is omitted.

---

## isBaseline(ModuleVersion|Module)

---

### Declaration

```
bool isBaseline(ModuleVersion modver| Module m)
```

## Operation

This returns `true` if, and only if, the given `ModuleVersion` or `module` represents a baseline of a module.

### baselineInfo(current Module)

#### Declaration

```
Baseline baselineInfo(Module m)
```

#### Operation

This returns the baseline designation information of the specified open module *m*. Returns null if *m* is a current version.

### baseline(ModuleVersion)

#### Declaration

```
Baseline baseline(ModuleVersion modver)
```

#### Operation

This returns a baseline handle with the major, minor and suffix settings extracted from the `ModuleVersion` *modver* supplied as an argument. The user, date and annotation will not be initialized. Returns null if *modver* corresponds to a current version.

### baselineExists(ModuleVersion)

#### Declaration

```
bool baselineExists(ModuleVersion modver)
```

#### Operation

This returns `true` if, and only if, the baseline referenced by the `ModuleVersion` *modver* argument exists in the database and can be read by the user.

### name(ModuleVersion)

#### Declaration

```
string name(ModuleVersion modver)
```

#### Operation

Returns the name of the module referenced by `ModuleVersion` *modver*. Returns null if *modver* does not refer to a module to which the user has read access.

---

## fullName(ModuleVersion)

---

### Declaration

```
string fullName(ModuleVersion modver)
```

### Operation

Returns the full name, including path, of the module referenced by `ModuleVersion modver`. Returns null if `modver` does not refer to a module to which the user has read access.

---

## versionString(ModuleVersion)

---

### Declaration

```
string versionString(ModuleVersion modver)
```

### Operation

Returns the version ID specified in the `ModuleVersion modver`, in the format `<major>.<minor>` where there is no suffix, or `<major>.<minor>(<suffix>)`. If `modver` specifies a current version, this perm returns null.

---

## delete(Baseline)

---

### Declaration

```
void delete([Module m,] Baseline b)
```

### Operation

Deletes the specified baseline in a formal module. First argument defaults to the current module.

---

## getMostRecentBaseline(Module)

---

### Declaration

```
Baseline getMostRecentBaseline(Module m[, bool deleted])
```

### Operation

Updated the `getMostRecentBaseline` perm to take an optional 2nd argument which if `true` directs the perm to return the version number of the last baseline even if it has been deleted. Otherwise, it returns the last baseline which still exists.

---

## Baseline Set Definition

---

### for BaselineSetDefinition in Folder

---

#### Declaration

for *baseSetDef* in *f*

where:

*baseSetDef* is a variable of type  
BaselineSetDefinition

*f* is a variable of type Folder

#### Operation

This will return all Baseline Set Definitions *baseSetDef* whose descriptions are held in the given Folder *f*, which might also be a Project, to which the user has Read access. The Folder's Baseline Set Definition list is read from the database at the start of this iterator.

---

### for BaselineSetDefinition in ModName\_

---

#### Declaration

for *baseSetDef* in *modRef*

where:

*baseSetDef* is a variable of type BaselineSetDefinition

*modRef* is a variable of type ModName\_

#### Operation

This returns all of the Baseline Set Definitions to which the user has Read access, which include the specified module in their lists.

---

### create(BaselineSetDefinition)

---

#### Declaration

string create(Folder *f*, string *name*, string *desc*, BaselineSetDefinition &*bsd*)

## Operation

This enables a user with Create access in the Folder to create a new Baseline Set Definition *bsd* with the given name and description. The new Baseline Set Definition will initially inherit its access controls from the folder. The name must conform to the constraints which apply to folder names, and must be unique across the other Baseline Set Definitions in that same folder. The description *desc* might be an empty string.

The newly created Baseline Set Definition is returned in the supplied *bsd* parameter.

The returned string will be non-null in the case that the Baseline Set Definition could not be created :

- If the name clashes with the name of some other Baseline Set Definition on that Folder
- Some i/o or lock error
- Insufficient access

In this case, no Baseline Set Definition will be created (the *bsd* reference will be set to null)

## rename(BaselineSetDefinition)

### Declaration

```
string rename(BaselineSetDefinition bsd, string newName)
```

### Operation

This enables a user with Modify access to change the name of the Baseline Set Definition *bsd*. It returns null on success, and an error message on failure, including insufficient access, or the Baseline Set Definition not being locked for edit, or the name not being unique in that Folder.

## name(BaselineSetDefinition)

### Declaration

```
string name(BaselineSetDefinition bsd)
```

### Operation

This returns the name of the given Baseline Set Definition *bsd*.

## setDescription(BaselineSetDefinition)

### Declaration

```
string setDescription(BaselineSetDefinition bsd, string desc)
```

### Operation

This enables a user with Modify access to change the description of the Baseline Set Definition. It returns null on success, and an error message on failure, including insufficient access.

A lock on the Baseline Set Definition is required to change the description of that Baseline Set Definition. This lock must be acquired using the `lock()` perm.



---

## description(BaselineSetDefinition)

---

### Declaration

```
string description(BaselineSetDefinition bsd)
```

### Operation

This returns the description text for the given Baseline Set Definition *bsd*. If the Baseline Set Definition's information has not been read, this will cause the information to be read from the database.

---

## for module in BaselineSetDefinition

---

### Declaration

```
for modRef in bsd do {
    ...
}
```

where:

<i>modRef</i>	is a variable of type <code>ModName_</code>
<i>bsd</i>	is a variable of type <code>BaselineSetDefinition</code>

### Operation

This returns references to all modules (to which the user has Read access) which are included in the Baseline Set Definition *bsd*. If the Baseline Set Definition information has not been read, this will cause the information to be read from the database. Modules that have been deleted (but not purged) are included in the list of modules returned by this iterator.

---

## addModule(BaselineSetDefinition)

---

### Declaration

```
string addModule(ModName_ modRef, BaselineSetDefinition bsd)
```

### Operation

This enables a user with Modify access to add a module to the Baseline Set Definition's list, if the Baseline Set Definition *bsd* is locked by the user. It will return a string on error, for example if the user does not have Modify access to the Baseline Set Definition or a lock on the Baseline Set Definition.

---

## removeModule(BaseLineSetDefinition)

---

### Declaration

```
string removeModule(ModName_ modRef, BaselineSetDefinition bsd)
```

### Operation

This enables a user with Modify access to remove a module from the Baseline Set Definition's list, if the Baseline Set Definition *bsd* is locked by the user.

---

## delete(BaselineSetDefinition)

---

### Declaration

```
string delete(BaselineSetDefinition &bsd)
```

### Operation

This enables a user with Delete access to delete a Baseline Set Definition from its parent folder. Once a Baseline Set Definition has been deleted, it cannot be undeleted. On success, the argument Baseline Set Definition will be set to null. A Baseline Set Definition cannot be deleted if another user has it locked for editing.

---

## lock(BaselineSetDefinition)

---

### Declaration

```
string lock(BaselineSetDefinition bsd)
```

### Operation

If the user has Modify access to the Baseline Set Definition *bsd*, this places an exclusive editing lock on it, and reads the information on the Baseline Set Definition from the database. It also ensures that there is a share-lock on its parent folder. Only one session can have a lock at any one time on a Baseline Set Definition, and only a session with a lock can save or modify the Baseline Set Definition, or create a Baseline Set from it. A Baseline Set Definition cannot be modified without it being locked.

Moreover, changes will not be saved to the database until and unless the user performs a save (`BaselineSetDefinition`).

Notice that it is the responsibility of the programmer to call `unlock (BaselineSetDefinition)` in order to release a Baseline Set Definition lock acquired by `lock (BaselineSetDefinition)`.

---

## unlock(BaselineSetDefinition)

---

### Declaration

```
string unlock(BaselineSetDefinition bsd)
```

## Operation

This unlocks a locked Baseline Set Definition *bsd*, and unlocks its parent Folder if that is not held locked for some other reason. If changes have been made and not saved since the Baseline Set Definition was locked, the Baseline Set Definition information will be read again from the database.

## save(BaselineSetDefinition)

### Declaration

```
string save(BaselineSetDefinition bsd)
```

### Operation

This saves the user's Baseline Set Definition information to the database, as long as the user has an editing lock on the Baseline Set Definition. It returns null on success, and an error message on failure.

## read(BaselineSetDefinition)

### Declaration

```
string read(BaselineSetDefinition bsd)
```

### Operation

This reads the current Baseline Set Definition *bsd* information from the database, and does not require a lock.

If the Baseline Set Definition is locked, and unsaved changes have been made to it, those changes will be lost when `read()` is called.

## isAnyBaselineSetOpen(BaselineSetDefinition)

### Declaration

```
bool isAnyBaselineSetOpen(BaselineSetDefinition bsd)
```

### Operation

Returns `true` if the `BaselineSetDefinition` has an open baseline set associated with it, and `false` if it does not. A null argument results in a run-time error.

## get(BaselineSetDefinition)

### Declaration

```
AccessRec get(BaselineSetDefinition bsd, string user, string &message)
```

## Operation

On success, this returns the access record for the Baseline Set Definition *bsd* for the specified user. If *user* is null, the default access will be returned. The *&message* string is null on success, and set to an error message on failure.

## inherited(BaselineSetDefinition)

### Declaration

```
string inherited(BaselineSetDefinition bsd)
```

### Operation

This enables the user to set the Baseline Set Definition *bsd* to inherit its access controls from its parent Folder.

## specific(BaselineSetDefinition)

### Declaration

```
string specific(BaselineSetDefinition bsd)
```

### Operation

If the Baseline Set Definition *bsd* has inherited access rights, this gives it specific access rights, with their initial values inherited from its parent Folder.

## isAccessInherited(BaselineSetDefinition)

### Declaration

```
string isAccessInherited(BaselineSetDefinition bsd, bool &inherited)
```

### Operation

This sets the inherited argument *true* or *false* depending on whether the Baseline Set Definition's access rights are inherited. It returns null on success, and an error message on failure.

## set(BaselineSetDefinition)

### Declaration

```
string set(BaselineSetDefinition bsd, Permission ps, string user)
```

### Operation

This sets a specific access permission for a given *user*. If *user* is null, then it sets a default access permission. It returns null on success, and an error string on failure.

---

## unset(BaselineSetDefinition)

---

### Declaration

```
string unset(BaselineSetDefinition bsd, string user)
```

### Operation

This removes specific access rights for the given *user* on BaselineSetDefinition *bsd*. If *user* is null, then it sets a default access permission. It returns null on success, and an error string on failure.

---

## unsetAll(BaselineSetDefinition)

---

### Declaration

```
string unsetAll(BaselineSetDefinition bsd)
```

### Operation

This removes all specific access rights from the Baseline Set Definition *bsd*. It returns null on success, and an error message on failure.

---

## for access record in Baseline Set Definition

---

### Declaration

```
for ar in bsd do {
    ...
}
```

where:

*ar* is a variable of type AccessRec

*bsd* is a variable of type  
BaselineSetDefinition

### Operation

This returns all the specific access right records for the specified Baseline Set Definition.

---

## for access record in all Baseline Set Definition

---

### Declaration

```
for ar in all bsd do {
    ...
}
```

```
}
```

where:

*ar* is a variable of type `AccessRec`

*bsd* is a variable of type `BaselineSetDefinition`

## Operation

Iterates over the access records of the applicable ACL for the specified Baseline Set Definition.

### Example 1

```
void createBSD()
// creates a BSD containing all the Formal modules in the current Folder
{
    BaselineSetDefinition newBSD = null
    string bsdName = (name current Folder) " modules"
    string bsdDesc = "All modules in this folder"
    string errmess
    errmess = create(current Folder, bsdName, bsdDesc, newBSD)
    if (!null errmess)
    {
        errorBox "Unable to create a new Baseline Set Definition: " errmess
        return
    }
    errmess = lock(newBSD)
    if (!null errmess)
    {
        errorBox "Cannot lock new Baseline Set Definition: " errmess
        return
    }

    // Add modules
    Item i
    ModName_ mod
    for i in current Folder do
    {
        if (type(i) == "Formal")
```

```

    {
        mod = module(fullName i)
        {
            if (!null mod)
            {
                errmess = addModule(mod, newBSD)
                if (!null errmess)
                {
                    errorBox "Could not add module " name(mod) ": " errmess
                }
            }
        }
    }
}

errmess = save(newBSD)
if (!null errmess)
{
    errorBox "Failed to save Definition: " errmess
}

unlock(newBSD)
}

```

createBSD

## Example 2

```

void printBSDs()
// prints a list of Baseline Set Definitions in the current Folder
// and a list of modules in each Baseline Set Definition
{
    BaselineSetDefinition bsd

    for bsd in current Folder do
    {
        print name(bsd) ": " description(bsd) "
    }
}

```

```

string errmess = read(bsd)
if (!null errmess)
{
    print "    [Could not read Definition: " errmess "]"
}
else if (isEmpty(bsd))
{
    print "    [Empty Baseline Set Definition]"
}
else
{
    ModName_ mod
    for mod in bsd do
    {
        print "    " (fullName mod) "
    }
}
print ""
}
}

printBSDs

```

---

## Baseline Sets

---

### for BaselineSet in BaselineSetDefinition

---

#### Declaration

```

for bs in bsd do {
    ...
}

```



```
}

```

where:

```
bs           is a variable of type BaselineSet
bsd        is a variable of type BaselineSetDefinition
```

## Operation

This returns the Baseline Sets, in order of creation, which have been created from a given Baseline Set Definition.

## isBaselinePresent(BaselineSet)

### Declaration

```
bool isBaselinePresent(BaselineSet bs, ModName_ modRef)
```

### Operation

This returns `true` if, and only if, a baseline of the module referenced by `modRef` is in the `BaselineSet bs`.

## create(Baseline Set)

### Declaration

```
string create(BaselineSetDefinition bsd, bool major, string suffix, string
annotation, BaselineSet &bs)
```

### Operation

This enables a user with `Create` access to create a new (Open) Baseline Set `&bs` from the Baseline Set Definition `bsd`. If `major` is `true`, the version of the Baseline Set will be a new major version number; else it will be a new minor version number. This fails if the Baseline Set Definition is not locked by the user, or if there is already an Open baseline set for it.

The returned string will be null on success, with `&bs` assigned to the baseline set so created. Otherwise, the returned string will be non-null and will contain some description of the failure, in this case `&bs` will be set to null.

## major(BaselineSet)

### Declaration

```
int major(BaselineSet bs)
```

### Operation

This returns the major version number of a Baseline Set `bs`.

---

## minor(BaselineSet)

---

### Declaration

```
int minor(BaselineSet bs)
```

### Operation

This returns the minor version number of a Baseline Set *bs*.

---

---

## suffix(BaselineSet)

---

### Declaration

```
string suffix(BaselineSet bs)
```

### Operation

This returns the suffix (might be null) in the version identifier of the Baseline Set *bs*.

---

---

## versionID(BaselineSet)

---

### Declaration

```
string versionID(BaselineSet bs)
```

### Operation

This returns the whole version identifier of the Baseline Set *bs* in the form `major.minor[(suffix)]`.

---

---

## annotation(BaselineSet)

---

### Declaration

```
string annotation(BaselineSet bs)
```

### Operation

This returns the comment annotation which has been stored with a Baseline Set *bs*.

---

---

## user(BaselineSet)

---

### Declaration

```
string user(BaselineSet bs)
```

### Operation

This returns the name of the user who created the Baseline Set *bs*.

---

---

## dateOf(BaselineSet)

---

### Declaration

```
Date dateOf(BaselineSet bs)
```

### Operation

This returns the date/time when the Baseline Set *bs* was created.

---

## isOpen(BaselineSet)

---

### Declaration

```
bool isOpen(BaselineSet bs)
```

### Operation

This returns `true` for an Open Baseline Set *bs*, and `false` for a Closed one.

---

## close(baselineSet)

---

### Declaration

```
string close(BaselineSet bs)
```

### Operation

This closes an Open Baseline Set *bs*. It requires the user to have a lock on the Baseline Set Definition, and returns null on success, and an error message on failure (e.g. if the Baseline Set is not Open, or the user does not hold a lock on the Baseline Set Definition).

---

## setAnnotation(BaselineSet)

---

### Declaration

```
string setAnnotation(BaselineSet bs)
```

### Operation

This enables a user with Modify access to the Baseline Set Definition to change the annotation text on an Open Baseline Set *bs*. It returns null on success, and an error string on failure (e.g. if `BaselineSet` is Closed). This should fail if the user does not have a lock on the Baseline Set Definition.

---

## addBaselines(BaselineSet)

---

### Declaration

```
string addBaselines(Skip modList, BaselineSet bs)
```

### Operation

This enables a user with Modify access to the Baseline Set Definition to baseline a set of modules and add the baselines to an Open Baseline Set. The variable *modList* is a skip list containing values of type *modName\_*. These modules must be included in the Baseline Set Definition which defines the Baseline Set, and must not already be contained in the Baseline Set. It returns null on success, and an error message on failure (e.g. if the BaselineSet is Closed). It fails without creating or adding any baselines if the user cannot add all of them. It fails if the user does not hold a lock on the Baseline Set Definition.

---

## for ModuleVersion in BaselineSet

---

### Declaration

```
for modver in bs do {
    ...
}
```

where:

<i>modver</i>	is a variable of type <code>ModuleVersion</code>
<i>bs</i>	is a variable of type <code>BaselineSet</code>

### Operation

This returns references to all of the baselines, to which the user has Read access, in the Baseline Set.

---

## for ModuleVersion in all BaselineSet

---

### Declaration

```
for modver in all bs do {
    ...
}
```

where:

<i>modver</i>	is a variable of type <code>ModuleVersion</code>
<i>bs</i>	is a variable of type <code>BaselineSet</code>

## Operation

This returns references to all baselines in the Baseline Set and all modules which could have been included in the Baseline Set, to which the user has Read access, and which have not been purged.

### for BaselineSet in ModName\_

#### Declaration

```
for bs in modRef do {
    ...
}
```

where:

*bs* is a variable of type `BaselineSet`

*modRef* is a variable of type `ModName_`

#### Operation

This returns any open Baseline Sets to which the current version of the specified module can currently be baselined.

### baselineSet(ModuleVersion)

#### Declaration

```
BaselineSet baselineSet (ModuleVersion modver)
```

#### Operation

This returns the Baseline Set, if there is one and the user has Read access to it, which contains the given `ModuleVersion` *modver*.

#### Example 1

```
void printModuleBSDs ()
// prints a list of Baseline Set Definitions which include the current Module
// and a list of Baseline Sets created for each Definition
{
    if (null current Module)
    {
        errorBox "This DXL must be run from a current Module."
        return
    }
}
```

```

BaselineSetDefinition bsd
ModName_ mod = module(current Module)
for bsd in mod do
{
    print name(bsd) ": " description(bsd) "\n"

    string errmess = read(bsd)
    if (!null errmess)
    {
        print "    [Could not read Definition: " errmess "]"
    }
    else if (isEmpty(bsd))
    {
        print "    [Empty Baseline Set Definition]"
    }
    else
    {
        BaselineSet bs
        for bs in bsd do
        {
            print versionID(bs) ": " annotation(bs) ""

            print "Created by " user(bs) " on " dateOf(bs) ""

            ModuleVersion mv
            for mv in bs do
            {
                print "    " (fullName mv) " [" (versionString mv) "]"

            }
        }
    }
    print "\n"
}

```

```

}
printModuleBSDs

```

## Example 2

```

void baselineModuleToSets()
// Adds a new baseline of the current module to any open
// Baseline Set that can include it. Creates a new Baseline Set
// for definitions that include the module but do not have an
// open Baseline Set.
{
    if (null current Module)
    {
        errorBox "This DXL must be run from a current Module."
        return
    }

    string errmess
    BaselineSetDefinition bsd
    BaselineSet bs
    ModName_ mod = module(current Module)
    int skipIndex = 0
    Skip moduleSkip = create
    put (moduleSkip, skipIndex++, mod)

    for bsd in mod do
    {
        print ""

        if (!isAnyBaselineSetOpen(bsd))
        {
            print "Creating new Baseline Set: "

            errmess = lock(bsd)
            if (null errmess)
            {

```

```
                errmess = create(bsd, true, "new", "Created by
baselineModuleToSets()", bs)
            }

            if (!null errmess)
            {
                print "Failed to create Baseline Set: " errmess "

                continue
            }
            unlock(bsd)
        }
    else
    {
        for bs in bsd do
        {
            if (isOpen bs)
            {
                break
            }
        }
    }

    if (isBaselinePresent(bs, mod))
    {
        print "Module is already in the Open Baseline Set."
    }
    else
    {
        errmess = addBaselines(moduleSkip, bs)
        if (null errmess)
        {
            print "Added baseline to Baseline Set " versionID(bs)
        }
    }
}
```



```

        }
    else
    {
        print "Failed to add baseline to Baseline Set: " errmsg
    }
}
}
}
baselineModuleToSets

```

---

## History

This section defines DXL functions for manipulating history records. Three main data types are introduced:

<code>History</code>	a history record
<code>HistoryType</code>	a type of history
<code>HistorySession</code>	a summary of a module's session history. Every time a Rational DOORS module is opened in either edit or shareable mode, a session summary is saved. You can access this information using the functions that act on an object of type <code>HistorySession</code> .

You can only access objects of type `History` and `HistoryType` using the `for history record in type` loop.

You can only access an object of type `HistorySession` using the `for history session in module` loop.

---

## Constants (history type)

---

### Declaration

```

const HistoryType unknown
const HistoryType createType
const HistoryType modifyType
const HistoryType deleteType
const HistoryType createAttr
const HistoryType modifyAttr
const HistoryType deleteAttr

```

```
const HistoryType createObject
const HistoryType copyObject
const HistoryType moveObject
const HistoryType modifyObject
const HistoryType deleteObject
const HistoryType unDeleteObject
const HistoryType purgeObject
const HistoryType clipCutObject
const HistoryType clipMoveObject
const HistoryType clipCopyObject
const HistoryType createModule
const HistoryType baselineModule
const HistoryType partitionModule
const HistoryType acceptModule
const HistoryType returnModule
const HistoryType rejoinModule
const HistoryType createLink
const HistoryType modifyLink
const HistoryType deleteLink
const HistoryType insertOLE
const HistoryType removeOLE
const HistoryType changeOLE
const HistoryType pasteOLE
const HistoryType cutOLE
const HistoryType readLocked
const HistoryType synchronizeModule
const HistoryType commentModule
const HistoryType commentObject
```

## Operation

These constants represent the different types of history record.

---

## Concatenation (history type)

---

The space character is the concatenation operator, which is shown as <space> in the following syntax:

```
HistoryType ht <space> string s
```

Concatenates the string *s* onto the history type *ht*, and returns the result as a string.

---

## History properties

---

Properties are available for use in combination with the `.` (dot) operator to extract information from a history record. Notably, the properties which are available for individual history entry will depend on the type of that entry. The syntax for using the properties is:

```
hr.property
```

where:

*hr* is a variable of type `History`

*property* is one of the history properties

The value of *property* can be one of the following:

String property	Extracts
<code>attrName</code>	attribute name of history record
<code>author</code>	author of history record
<code>newPosition</code>	new position of history record
<code>position</code>	current position of history record
<code>type</code>	type of history record; this can be one of the values listed in “Constants (history type),” on page 331
<code>typeName</code>	type name of history record
<code>targetInitialName</code>	the name of the target module at the time of link creation (only available to the administrator)
<code>linkInitialName</code>	the name of the link module at the time of link creation (only available to the administrator)
<code>plainOldValue</code>	plain text version of the old value
<code>plainNewValue</code>	plain text version of the new value
<code>plainOldUnicodeValue</code>	plain text version of the old value, but with any <code>Symbol</code> characters converted into the equivalent Unicode characters, so that the value matches the displayed rich text value
<code>plainNewUnicodeValue</code>	plain text version of the new value, but with any <code>Symbol</code> characters converted into the equivalent Unicode characters, so that the value matches the displayed rich text value

---

<b>Date property</b>	<b>Extracts</b>
date	date of history record

<b>Integer property</b>	<b>Extracts</b>
absNo	absolute number of history record
numberOfObjects	number of objects in history record
oldAbsNo	old absolute number of history record
sessionNo	tracks the manipulation of history information
sourceAbsNo	the absolute number of the source object
targetAbsNo	the absolute number of the target object

<b>ModuleVersion property</b>	<b>Extracts</b>
linkVersion	the version of the link module
targetVersion	the version of the target module

<b>Any appropriate type property</b>	<b>Extracts</b>
newValue	new value of user defined attribute
oldValue	old value of user defined attribute

## Example

```
print hr.type
print hr.date
print hr.author
print hr.attrName
print hr.typeName
print hr.position
print hr.newPosition
print hr.numberOfObjects
```

```

print hr.absNo
print hr.oldAbsNo
print hr.sessionNo
Date histDatOld = hr.oldValue
Date histDateNew = hr.newValue

```

---

## goodStringOf

---

### Declaration

```
string goodStringOf(HistoryType ht)
```

### Operation

Returns a string to represent the history type *ht* in the user interface, for example, "Create Object" for the createObject history type.

---

## stringOf(history type)

---

### Declaration

```
string stringOf(HistoryType ht)
```

### Operation

Returns the history type *ht* as a string.

---

## print(history type)

---

### Declaration

```
void print(HistoryType ht)
```

### Operation

Prints the history type *ht* in the DXL Interaction window's output pane.

---

## for history record in type

---

### Syntax

```

for hr in type do {
  ...
}

```

where:

`hr` is a variable of type `History`

`type` is a variable of type `Module`, object of type `Object`, or a call to the function `top`

## Operation

Assigns the variable `hr` to be the history records for modules, objects, or top-level items. Top-level items are those module history records that apply to the whole module, not individual objects. The syntax for looping through top-level items is as follows:

```
for hr in top(module) do { ... }
```

where `module` is of type `Module`.

## Example

This example prints out the `type` of each top level history record of the current module:

```
History h
for h in top current Module do print h.type
```

## number(history session)

### Declaration

```
int number(HistorySession hs)
```

### Operation

Returns an identifier that is unique within the parent module for a particular session, starting from 0.

## when

### Declaration

```
Date when(HistorySession hs)
```

### Operation

Returns the timestamp for a particular session.

## who

### Declaration

```
string who(HistorySession hs)
```

## Operation

Returns the name of the Rational DOORS user responsible for a particular session (who opened the module).

### baseline(history session)

#### Declaration

```
string baseline(HistorySession hs)
```

#### Operation

If a baseline was created during a particular session, returns the details in the format `version(suffix)`.

### diff(buffer)

#### Declaration

```
string diff(Buffer result, Buffer source, Buffer target, string removeMarkup,
insertMarkup)
```

```
string diff(Buffer result, Buffer source, Buffer target)
```

```
string diff(Buffer result, Buffer source, Buffer target, bool fullRTF)
```

#### Operation

Computes the annotated difference, or "redlined difference" between source and target.

The result is valid only when a non-null string is returned.

Removals and insertions are annotated by `removeMarkup` and `insertMarkup` -- this must be well-formed RTF strings onto which subsequent text might be concatenated. The standard values for these are `"\cf1\strike "` and `"\cf2\ul "` (notice the spaces). See `diff/3` for a perm which uses these defaults.

Three colors are defined and might be used within these commands: RED, GREEN and BLUE:

```
\cf1 - RED
```

```
\cf2 - GREEN
```

```
\cf3 - BLUE
```

For the third form of the perm, When `true`, the RTF returned as a result is full RTF (containing the correct RTF header, font table and color table). When `false`, the returned result is an RTF fragment, suitable for adding or inserting into a full RTF stream.

#### Example

```
DB db = create "Show diff"
DBE textbox = richText(db, "stuff", "", 200, 200, true)
Buffer buff1 = create()
Buffer buff2 = create()
Buffer resBuf = create()
```

```

buff1 = "Old Text"
buff2 = "New Text"
diff(resBuf, buff1, buff2, "\\cf1\\strike ", "\\cf3\\ul ")
realize db
useRTFColour(textbox, true)
set(textbox, tempStringOf resBuf)
show db

delete resBuf
delete buff1
delete buff2

```

## Example

```

Buffer one = create
one = "one"
Buffer two = create
two = "two"
Buffer result = create

diff(result, one, two, false)
print stringOf(result) "\n\n"
diff(result, one, two, true)
print stringOf(result)

```

Output:

```
{\cf1\strike one}{\cf3\ul two}
```

```

{\rtf1\deff1000{\fonttbl{\f1012\fswiss\fcharset177 Arial;}{\f1011\fswiss\fcharset162
Arial;}{\f1010\fswiss\fcharset238 Arial;}{\f1009\fswiss\fcharset204 Arial;}{\f1008\fswiss\fcharset161
Arial;}{\f1007\fswiss\fcharset0 Arial;}{\f1006\froman\fcharset177 Times New
Roman;}{\f1005\froman\fcharset162 Times New Roman;}{\f1004\froman\fcharset238 Times New
Roman;}{\f1003\froman\fcharset204 Times New Roman;}{\f1002\froman\fcharset161 Times New
Roman;}{\f1001\ftch\fcharset2 Symbol;}{\f1000\froman\fcharset0 Times New Roman;}}{\colortbl
;\red255\green0\blue0;\red0\green255\blue0;\red0\green0\blue255;}{\cf1\strike one}{\cf3\ul two}}

```



---

## Link History

---

The name of a module level boolean attribute which controls whether history for link creation and deletion is recorded. Used as a normal attribute but with the addition of the `reserved` keyword.

### Example

```
const string LINK_HISTORY_ATTRNAME = "Link History"
Module m = current

if (m != null){

    // get the value
    bool linkHistoryBefore = m.(reserved LINK_HISTORY_ATTRNAME)

    // set the value
    m.(reserved LINK_HISTORY_ATTRNAME) = !linkHistoryBefore

    // get the value again
    bool linkHistoryAfter = m.(reserved LINK_HISTORY_ATTRNAME)

    print "Before: " linkHistoryBefore "\n"
    print "After: " linkHistoryAfter "\n"
}
```

---

## lastModifiedTime

---

### Declaration

```
Date lastModifiedTime({Module|Object|Link})
```

### Operation

Returns the date the supplied item was last modified, including the time of the modification.

---

## for history session in module

---

### Syntax

```
for hs in module do {
  ...
}
```

where:

*hs* is a variable of type `HistorySession`

*module* is a variable of type `Module`

### Operation

Assigns the variable *hs* to be each successive history session record for the specified module.

### Example

```
HistorySession hs
// process module
for hs in current Module do
{
  // identifier, date and user
  print number(hs) " ", " when(hs) ", " who(hs)
  string sBaseline = baseline(hs)
  // only relevant if baseline info exists
  if (sBaseline != null)
  {
    // baseline name
    print " - '" sBaseline "' : "
  }
  print "\n"
}
```

---

## History example program

---

```
// history DXL Example
/*
  Example history DXL program.
  Generate a report of the current Module's
  history.
*/
// print a brief report of the history record
```

```

void print(History h) {
    HistoryType ht = h.type
    print h.author "\t" h.date "\t" ht "\t"
    if (ht == createType ||
        ht == modifyType ||
        ht == deleteType) { // attribute type
        print h.typeName
    } else if (ht == createAttr ||
        ht == modifyAttr ||
        ht == deleteAttr) {
        // attribute definition
        print h.attrName
    } else if (ht == createObject ||
        ht == clipCopyObject ||
        ht == modifyObject) { // object
        print h.absNo
        if (ht==modifyObject) {
            // means an attribute has changed
            string oldV = h.oldValue
            string newV = h.newValue
            print " (" h.attrName ":" oldV " -> "
                newV ")"
        }
    }
    print "\n"
}
// Main program
History h
print "All history\n\n"
for h in current Module do print h
print "\nHistory for current Object\n\n"
for h in current Object do print h
print "\nNon object history\n\n"
for h in top current Module do print h

```

---

## Descriptive modules

This section defines DXL functions for Rational DOORS descriptive modules.

---

## create(descriptive module)

---

### Declaration

```
Module create(string name,
              string description,
              string prefix,
              int absno,
              string filename)
```

### Operation

Creates a new descriptive module based on a valid module name and an accessible text file.

If the operation succeeds, returns a reference to the new module; otherwise, returns null.

### Example

```
Module m = create("Source", "source documentation", "S", 1, "c:\\docs\\source.txt")
```

---

## markUp

---

### Declaration

```
Object markUp(Object o,
              int firstchar,
              int lastchar)
```

### Operation

Marks up a range of object text in a descriptive module, as defined by *firstchar* and *lastchar*.

If the operation succeeds, returns a reference to the newly marked up object; otherwise, returns a reference to the unmarked up object.

If *firstchar* is 1 or less, the range begins at the first character.

If *lastchar* is greater than the number of characters in the specified object, the range ends with the last character in the object.

If *firstchar* is greater than the number of characters in the object, or if *lastchar* is less than 1, or less than *firstchar*, the extracted object contains no text.

### Example

This example marks up the 2nd, 3rd and 4th characters in the current object:

```
markUp(current Object, 2, 4)
```

---

## undoMarkUp

---

### Declaration

```
void undoMarkUp(Object o)
```

### Operation

Changes a descriptive module object *o* from being a marked up object to being an unmarked up object. If *o* does not refer to a marked-up object, the function has no effect.

### Example

```
undoMarkUp(current object)
```

---

## setUpExtraction

---

### Declaration

```
bool setUpExtraction(Module m,  
                     string formal,  
                     string link)
```

### Operation

Sets up the descriptive module *m* for the extraction of marked up objects to the formal module *formal*, with links between the source objects and the extractions stored in the link module *link*.

For a successful operation *formal* must be open in edit mode, and *link* must be available for editing.

If the operation is successful, it returns `true`; otherwise, it returns `false`.

### Example

```
print setUpExtraction(current Module, "Formal mod", "DOORS Links")
```

---

## extractAfter

---

### Declaration

```
void extractAfter(Object source)
```

### Operation

Extracts the marked-up object *source* to a new object after the current object in the formal module as specified by *setUpExtraction*.

If the extraction has been incorrectly set up, the function displays a run-time error message is displayed and performs no extraction.

If the extraction is successful, the new object in the formal module becomes the current object.

## Example

```
Module desc = create("Desc mod", "descriptive module", "D", 1, "c:\\info.txt")
Object obj=markUp(current Object 2,22)
edit "Formal module"
setUpExtraction(desc, "Formal module", "Link module")
extractAfter(obj)
```

---

## extractBelow

---

### Declaration

```
void extractBelow(Object source)
```

### Operation

Performs the same operation as *extractAfter*, but inserts the new object below the current object in a formal module.

### Example

```
Module desc = create ("Desc mod", "descriptive module", "D", 1, "c:\\info.txt")
Object obj=markUp(current Object 2,22)
edit "Formal module"
setUpExtraction(desc, "Formal module", "Link module")
extractBelow(obj)
```

---

## Recently opened modules

This section defines DXL functions to access and manipulate the list of recently opened modules.

---

## recentModules

---

`recentModules` is a new data type representing the list of recently opened modules.

---

## addRecentlyOpenModule(ModuleVersion)

---

### Declaration

```
void addRecentlyOpenModule(ModuleVersion ModVer)
```

### Operation

Adds an entry into the recently opened modules list for the supplied module version.

---

## addRecentlyOpenModule(string)

---

### Declaration

```
void addRecentlyOpenModule(string)
```

### Operation

Constructs a module version from the supplied string, then adds an entry in the recently opened modules list for that module version.

---

## removeRecentlyOpenModule(ModuleVersion)

---

### Declaration

```
void removeRecentlyOpenModule(ModuleVersion ModVer)
```

### Operation

Removes the entry for the supplied module version from the recently opened modules list.

---

## for {string|ModuleVersion} in recentModules

---

### Operation

Loops through the list of recently opened modules and returns the string representing uniqueID, including baseline version string, or `ModuleVersion`, for each module.

### Syntax

```
for {str|mv} in recentModules do {
    ...
}
```

where:

<i>str</i>	is a variable of type <code>string</code>
<i>mv</i>	is a variable of type <code>ModuleVersion</code>
<i>recentModules</i>	is the list of recently opened modules

### Example

```
// This example loops through the list of recently opened modules. It checks for
// the presence of two modules, if the first is found it is removed, if the
//second is found it is added.
```

```
ModuleVersion mod1 = moduleVersion("00000023")
```

```
ModuleVersion mod2 = moduleVersion("00000021")
ModuleVersion mod

bool found1 = false
bool found2 = false

for mod in recentModules do {

    if (mod == mod1){
        found1 = true
    } else if (mod == mod2){
        found2 = true
    }
}

if (found1){
    removeRecentlyOpenModule mod1
}

if (!found2){
    addRecentlyOpenModule mod2
}
```

---

## Module Properties

---

### ModuleProperties

---

`ModuleProperties` is a new data type representing the properties of a module. It consists of type definitions, attribute definitions, and module attribute values. As with object and module types the `.` (dot) operator can be used to extract attribute value



---

## getProperties

---

### Declaration

```
string getProperties(ModuleVersion mv, ModuleProperties &mp)
```

### Operation

Loads type definitions, attribute definitions and module attribute values from the specified *ModuleVersion* into the specified *ModuleProperties*.

---

## delete(ModuleProperties)

---

### Declaration

```
void delete(ModuleProperties&)
```

### Operation

Deletes the supplied moduleProperties structure. If not called after a call to getProperties, the memory will only be released after the context is released.

---

## find(attribute definition in ModuleProperties)

---

### Declaration

```
AttrDef find(ModuleProperties mp, string AttrName)
```

### Operation

Returns the attribute definition from the specified *ModuleProperties* whose name matches the supplied string.

---

## for string in ModuleProperties

---

### Syntax

```
for str in modprops do {
...
}
```

where:

---

<i>str</i>	is a variable of type String
<i>modprops</i>	is a variable of type ModuleProperties

---

## Operation

Assigns *str* to be the name of each successive module attribute in *modprops*.

---

### for AttrType in ModuleProperties

---

#### Syntax

```
for at in modprops do {
...
}
where:
```

<i>at</i>	is a variable of type AttrType
<i>modprops</i>	is a variable of type ModuleProperties

#### Operation

Assigns *at* to be each successive module attribute type definition in *modprops*.

#### Example

```
ModuleProperties mp
ModuleVersion mv
string mname = "/My Project/Module1"
string s

mv = moduleVersion(module mname)

string err1 = getProperties (mv, mp)

if (!null err1){
    print err1 "\n"
}

AttrType at
print "Module Types: \n"
```

```
for at in mp do {
    print "\t - " (at.name) "\n"
}

print "\nModule Attributes: \n"
for s in mp do {
    print "\t - " s " : "
    val = mp.s""
    print val "\n"
}
```



## Chapter 17

# Electronic Signatures

This chapter contains the following topics:

- Signature types
- Controlling Electronic Signature ACL
- Electronic Signature Data Manipulation
- Examples

---

## Signature types

---

### struct SignatureInfo {}

---

A new type representing signature information.

### struct SignatureEntry {}

---

A new type representing individual signatures. A `SignatureEntry` is aggregated into exactly one `SignatureInfo` object.

---

## Controlling Electronic Signature ACL

All access control operations operate on the Electronic Signature information that has been read from the database. Therefore, read operations return results reflecting what was in effect when the data was last refreshed from the database. The data is refreshed by calling `getSignatureInfo`.

Write operations might result in changes to the access controls, but the access control perms do not commit those changes to the database. Instead, the DXL programmer must explicitly save any changes in order for them to be committed.

---

### SignatureInfoSpecifier\_\_ specifier(SignatureInfo)

---

#### Declaration

```
SignatureInfoSpecifier__ specifier(SignatureInfo si)
```

## Operation

This converter has a Ref implementation. It is an interface selector. It is used for getting and setting permissions for users to change the signature label specifier type for a baseline. It uses the same perms that are used for setting permissions to change the `SignatureInfo` itself (the rest of the signature configuration). The label specifier is an enumerated type defined in the module, which can have values like **signed off**, **rejected**, etc.

For example, if you have a `SignatureInfo` variable, say `sigInfo`, which has been initialized using `getSignatureInfo`, to give you a handle on the signature configuration for a particular baseline, then you get access controls on the signature list using:

- `string username`
- `string access`
- `AccessRec ac = get(sigInfo, username, access)`

Access controls on the label specifier can be retrieved using:

- `AccessRec ac2 = get(specifier sigInfo, username, access)`

---

## hasPermission(SignatureInfo, Permission)

---

### Declaration

```
bool hasPermission(SignatureInfo si, Permission& p)
```

### Operation

Returns `true` if the current user has permission `p` to the Signatory ACL of the `SignatureInfo` object `si`.

---

## hasPermission(SignatureInfoSpecifier\_\_, Permission)

---

### Declaration

```
bool hasPermission(SignatureInfoSpecifier__ sis, Permission& p)
```

### Operation

Returns `true` if the current user has permission `p` to the Specifier ACL of the `SignatureInfo` object `si`. The `specifier()` perm is used to cast a `SignatureInfo` object into a `SignatureInfoSpecifier__` object.

---

## hasPermission(string, SignatureInfo, Permission)

---

### Declaration

```
bool hasPermission(string name, SignatureInfo si, Permission& p)
```

### Operation

Returns `true` if the string `name` has permission `p` to the Signatory ACL of the `SignatureInfo` object `si`.

---

**hasPermission(string, SignatureInfoSpecifier\_\_, Permission)**

---

**Declaration**

```
bool hasPermission(string name, SignatureInfoSpecifier__ sis, Permission& p)
```

**Operation**

Returns true if the string *name* has permission *p* to the Specifier ACL of the SignatureInfo object *si*. The specifier () perm is used to cast a SignatureInfo object into a SignatureInfoSpecifier\_\_ object.

---



---

**::do(AccessRec&, SignatureInfo, void)**

---

**Declaration**

```
void ::do(AccessRec& ar, SignatureInfo si, void)
```

**Operation**

Iterator over Signatory ACL of the SignatureInfo object *si*.

---



---

**::do(AccessRec&, SignatureInfoSpecifier\_\_, void)**

---

**Declaration**

```
void ::do(AccessRec& ar, SignatureInfoSpecifier__ sis, void)
```

**Operation**

Iterator over Specifier ACL of the SignatureInfo object *si*.

---



---

**set(SignatureInfo, Permission, string name)**

---

**Declaration**

```
string set(SignatureInfo si, Permission& p, string name)
```

**Operation**

Sets the Signatory ACL so that string *name* has Permission *p*.

---



---

**set(SignatureInfoSpecifier\_\_, Permission, string name)**

---

**Declaration**

```
string set(SignatureInfoSpecifier__ sis, Permission& p, string name)
```

## Operation

Sets the Specifier ACL so that string *name* has Permission *p*.

### unset(SignatureInfo, string name)

#### Declaration

```
string unset(SignatureInfo si, string name)
```

#### Operation

Sets the Signatory ACL so that string *name* has the default access.

### unset(SignatureInfoSpecifier\_\_, string name)

#### Declaration

```
string unset(SignatureInfoSpecifier__ sis, string name)
```

#### Operation

Sets the Specifier ACL so that string *name* has the default access.

### unsetAll(SignatureInfo)

#### Declaration

```
string unsetAll(SignatureInfo si)
```

#### Operation

Sets Signatory ACL so that all agents have the default access

### unsetAll(SignatureInfoSpecifer\_\_)

#### Declaration

```
string unsetAll(SignatureInfoSpecifer__ sis)
```

#### Operation

Sets the Specifier ACL so that all agents have the default access

### AccessRec get(SignatureInfo, string name, string& error)

#### Declaration

```
AccessRec get(SignatureInfo si, string name, string& error)
```



## Operation

Returns the access record from the Signatory ACL for string *name*. Returns a non-null string if there is an error.

---

# Electronic Signature Data Manipulation

---



---

## getSignatureInfo(SignatureInfo si&, ModName\_ document, int major, int minor, string suffix)

---

### Declaration

```
string getSignatureInfo(SignatureInfo si&, ModName_ document, int major, int
minor, string suffix)
```

### Operation

Returns in *si* (destructively modifying its contents) a signature information object on the specified baseline *document* (module, with version information). In case of error, a non-null string will be returned, otherwise the null string will be returned.

If the baseline does not exist, this generates an error.

If the baseline does exist, a valid `SignatureInfo` object will be assigned to *si* and populated with data read from the database. The `isConfigured()` method will return `true`. If the baseline does not have a `SignatureInfo` object associated with it, a new one is created. The `isConfigured()` method returns `false`, and the `SignatureInfo` will contain some default values which are dependant on the last configuration specified for that module.

If there is signature information contained in the database for this baseline, that data will be read from the database and *si* will then reflect that data, at the time of the call to `getSignatureInfo`. Changes subsequently made to the database by other sessions will not be reflected in *si* until a further call to `getSignatureInfo` is made.

Since this perm destructively modifies the contents of *si*, any changes that have been made to *si* (for example, a call to `setLabelSpecifier`), are lost. Changes to a `SignatureInfo` object might be committed to the database by the `save` perm.

---

## isBaselineSignatureConfigured(SignatureInfo)

---

### Declaration

```
bool isBaselineSignatureConfigured(SignatureInfo si)
```

### Operation

Returns whether the `SignatureInfo` has been configured (if signature Access Controls or signatures have been saved for the associated baseline). See `getSignatureInfo()` for more details.

**Note:** This perm does not refresh the `SignatureInfo` object from the database.

---

## getLabelSpecifier(SignatureInfo)

---

### Declaration

```
string getLabelSpecifier(SignatureInfo si)
```

### Operation

Returns the signature label specifier. Does not refresh the signature information from the database.

---

## setLabelSpecifier(SignatureInfo si, string newLabel)

---

### Declaration

```
string setLabelSpecifier(SignatureInfo si, string newLabel)
```

### Operation

Sets the signature label specifier of the supplied *si* to be the supplied *newLabel*. This might fail and return a non-null error message if the current user does not have modify access conferred by the Specifier ACL.

This change to the label specifier is not committed to the database until the `save(SignatureInfo&)` method is called.

---

## appendSignatureEntry(SignatureInfo si, string label, string comment)

---

### Declaration

```
string appendSignatureEntry(SignatureInfo si, string label, string comment)
```

### Operation

Appends the signature of the current user to the database signature information of the baseline associated with *si*. This perm is only available when there is a user interface. It will return an error string otherwise. It prompts the user to reconfirm their user name and password, and if this reconfirmation is successful, appends and commits this new signature entry to any existing signatures that might be present in the database.

The `label` argument will be stored with the signature, and might be used to classify the signature. The baseline signature DXL constrains the user to select the label from the enumeration values of the module's label specifier type.

The `labelOptions` argument is intended to contain a newline-separated list of labels available to the user at the time of sign off, as enforced by the calling DXL code.

The `comment` argument is intended to store any comments that the signatory wishes to record with the signature.

This perm returns an error when Rational DOORS is running in batch mode.

A side-effect of this perm is to refresh *si* (as would `getSignatureInfo`) so that it reflects the data that has been committed to the database. As a consequence, any `SignatureEntry` objects derived from *si* will be invalidated. Also, any non-committed changes to *si* will be lost (use the `save` perm to commit changes before appending a signature).

Since this operation refreshes *si*, it is possible that the right to sign a baseline will be lost due to a change to the Signatory ACL. In this case an error message will be returned.

---

## save(SignatureInfo si, int &code)

---

### Declaration

```
string save(SignatureInfo si, int &code)
```

### Operation

Save signature information *si* to the database. Returns a non-null string if it fails, in which case the value of *code* will be set to indicate the reason for failure.

On success, this perm writes the specified signature information to the database. Any changes that were made to this signature information since it was refreshed (via `getSignatureInfo`) will be committed to the database.

It is not necessary to call `save` in order to commit changes made by calls to `appendSignatureEntry`. This perm commits those changes before it returns.

Changes made to signature information that do require an explicit call to `save()` are:

- `setLabelSpecifier()`  
Any change to access controls

Returned error codes:

- out of sequence commit
- other error

An out-of-sequence commit code arises when an attempt is made to commit changes based on an out-of-date read of the signature information. The code will be set to "2" in all other failure cases.

A side-effect of this perm is to refresh *si* (as would `getSignatureInfo`) so that it reflects the data that has been committed to the database. As a consequence, any `SignatureEntry` objects derived from *si* will be invalidated.

---

## ::do(SignatureEntry&, SignatureInfo, void)

---

### Declaration

```
void ::do(SignatureEntry& sigentry, SignatureInfo si, void)
```

### Operation

Iterator over each signature entry in the `SignatureInfo` object *si*. The signature entries so obtained are read-only.

The entities will be enumerated in the order in which they were appended to the `SignatureInfo`.

**Note:** This order is independent from the stored dates of the entries.

The signature entries so obtained will be invalidated by execution of any of the following perms on the same `SignatureInfo` object

- `getSignatureInfo`
- `save`
- `appendSignatureEntry`

As a result, these should not be called when `SignatureEntry` objects remain in scope.

---

## `getUserName(SignatureEntry)`

---

### Declaration

```
string getUserName(SignatureEntry sigentry)
```

### Operation

Returns the signatory's user name for the given signature entry.

---

## `getUserFullName`

---

### Declaration

```
string getUserFullName(SignatureEntry sigentry)
```

### Operation

Returns the signatory's full user name for the given signature entry.

---

## `getEmail(SignatureEntry)`

---

### Declaration

```
string getEmail(SignatureEntry sigentry)
```

### Operation

Returns the e-mail address of the signatory for the given signature entry.

---

## `Date getDate(SignatureEntry)`

---

### Declaration

```
Date getDate(SignatureEntry sigentry)
```

### Operation

Returns the signing date for the given signature entry.

**Note:** This function returns the GMT date/time of the signature and, when formatted to a string, will show the signature time in the time zone of the viewer, not of the signatory.

---

## Date getLocalDate(SignatureEntry)

---

### Declaration

```
Date getLocalDate(SignatureEntry sigentry)
```

### Operation

Returns the signing date of the given signature entry, offset to compensate for the time zones of the signatory and viewer.

---

## getFormattedLocalDate(SignatureEntry)

---

### Declaration

```
string getFormattedLocalDate(SignatureEntry sigentry)
```

### Operation

Returns a string representing the date and time of the specified signature in the time zone of the signatory, not the current viewer.

---

## getLabel(SignatureEntry)

---

### Declaration

```
string getLabel(SignatureEntry sigentry)
```

### Operation

Returns the label, if any, for the given signature entry.

---

## getLabelOptions(SignatureEntry)

---

### Declaration

```
string getLabelOptions(SignatureEntry sigentry)
```

### Operation

Returns a formatted string representing the choices of label entry available to the signatory at the time of signing.

---

## getComment(SignatureEntry)

---

### Declaration

```
string getComment(SignatureEntry sigentry)
```

## Operation

Returns the comment contained in a signature entry. This might be the empty string.

## allAttributesReadable(SignatureEntry)

### Declaration

```
bool allAttributesReadable(SignatureEntry sigentry)
```

### Operation

Returns a boolean indicating if the signatory had read access to all attributes on the signed baseline.

## getIsValid(SignatureEntry)

### Declaration

```
bool getIsValid(SignatureEntry sigentry)
```

### Operation

Returns a boolean value indicating whether the signature hash is still valid for the stored signature entry. This might be used to verify the integrity of signature data.

## Examples

### Add a signature to the latest baseline of the current module

```
// Example signatures code - add a signature to the latest baseline of the
current module.
```

```
Baseline thisBaseline = getMostRecentBaseline(current Module)
if (null thisBaseline || (null load(thisBaseline,true)))
{
    warningBox "No baseline available"
    halt
}
```

```
DB signatureDB
DBE addTypeChoice, addAddBtn, addCommentsText
```

```

SignatureInfo sigInfo
int enumCount = 0
int majorVersion = major(thisBaseline)
int minorVersion = minor(thisBaseline)
string suffix = suffix(thisBaseline)

//*****
void addAddCB(DBE x)
// DESCRIPTION : Callback for "OK" button on add signature
// dialog. Calls appendSignatureEntry perm to prompt the user
// to re-authenticate.
// On error, presents a warning box to the user.
// RETURNS : void
{
    string labelString = get(addTypeChoice)
    string commentString = get(addCommentsText)
    string optionsString = ""
    int i
    for (i = 0; i < enumCount; i++)
    {
        if (i > 0)
        {
            optionsString = optionsString "\n"
        }
        optionsString = optionsString get(addTypeChoice,i)
    }

    string message =
appendSignatureEntry(sigInfo,labelString,optionsString,commentString)
    if (!null message)
    {
        warningBox(signatureDB,"Signature not added: " message "")
    }
} // addAddCB

```

```

// First, read the SignatureInfo for the baseline..
string message = getSignatureInfo(sigInfo,module(fullName current
Module),majorVersion,minorVersion,suffix)
if (!null message)
{
    warningBox("getSignatureInfo failed: " message "")
    halt
}

// Create the dialog to allow the user to select a label and add a comment.
signatureDB = create("Add Signature",styleFixed)
string labelType = getLabelSpecifier(sigInfo)
AttrType at = null
enumCount = 0

// Get current list of labels from the current version of the module
if (!null labelType)
{
    Module currentVersion = read(fullName current Module,false)

    if (!null currentVersion)
    {
        at = find(current Module, labelType)
    }
    if (null at)
    {
        warningBox("Cannot find label specifier type \"" labelType "\".")
        halt
    }
    else if (at.type "" != "Enumeration")
    {
        warningBox("Label specifier is not an enumerated type.")
        halt
    }
}

```



```

        else
        {
            enumCount = at.size
        }
    }

string labelChoices[enumCount]

if (enumCount > 0)
{
    // Get alternative labels from the enumerated type.
    int index
    for (index = 0; index < enumCount; index++)
    {
        labelChoices[index] = at.strings[index]
    }
}

// Create the choice element for the user to select a label.
addTypeChoice = choice(signatureDB,"Signature Label: ",labelChoices,0,20,false)
if (enumCount == 0)
{
    inactive addTypeChoice
}

addCommentsText = text(signatureDB,"Comments:", "",400,150,false)
addAddBtn = button(signatureDB,"OK",addAddCB,styleStandardSize)

show signatureDB

```

---

## list signatures in the latest baseline

---

```

// Signatures example code : list signatures in the latest baseline
// of the current module

```

```

if (null current Module)
{
    warningBox "Must run from an open module."
    halt
}

Baseline b = getMostRecentBaseline(current Module)
if (null b || (null load(b,true)))
{
    warningBox "No baseline available"
    halt
}
string dummy[] = {}

DB signaturesDB = create("Baseline Signatures Example",styleFixed)
SignatureInfo signatureInfo = null

DBE timeCombo, sigListView, commentText
DBE labelLabel, labelList, closeBtn
string timeChoices[] = {"signatory's","current"}
DBE timeLabel

static int SIGNATORY_COL = 0
static int DATE_COL = 1
static int LABEL_COL = 2

//*****
void listSignature(SignatureEntry sigEntry, int i, bool localTimes)
// DESCRIPTION : adds an entry in the listView for a given signatureEntry
// RETURNS : void
{
    insert(sigListView,i,getUsername(sigEntry),null,iconUser)
    if (localTimes)

```

```

    {
        set(sigListView,i,DATE_COL,(dateOf intOf getLocalDate(sigEntry)) "")
    }
else
{
    set(sigListView,i,DATE_COL,(dateOf intOf getDate(sigEntry)) "")
}
set(sigListView,i,LABEL_COL,getLabel(sigEntry))
}

//*****
void refreshListView(void)
// DESCRIPTION : Populates sigListView with the info in signatureInfo
// RETURNS : void
// ERROR CONDITIONS : null signatureInfo - returns without any action
{
    if (null signatureInfo)
    {
        return
    }

    int i = get(timeCombo)
    bool localTimes = (i == 0)

    int entryNumber
    empty sigListView
    entryNumber = 0
    SignatureEntry sigEntry
    for sigEntry in signatureInfo do
    {
        listSignature(sigEntry,entryNumber,localTimes)
        entryNumber++
    }
} // void refreshListView(void)

```

```

//*****
void closeDB(DB x)
// DESCRIPTION : close function for the signature dialog. Hides it.
// RETURNS : void
{
    hide signaturesDB
    halt
}

//*****
void closeDB(DBE x)
// DESCRIPTION : close function for the signature dialog. Hides it.
// RETURNS : void
{
    closeDB(signaturesDB)
}

//*****
void refreshSigsDB()
// DESCRIPTION : refreshes the signatures list with the signature info from
//               the database, in the specified baseline.
// RETURNS : void
{
    ModName_ thisModule = module (fullName current Module)

    string message = getSignatureInfo(signatureInfo, thisModule, major(b),
minor(b), suffix(b))
    set(commentText, "")
    set(labelList, "")
    if (!null message)
    {
        warningBox(signaturesDB, "Cannot display signatures for this baseline:
" message "\nThe baseline signature dialogue will be closed.")
    }
}

```

```

        closeDB(signaturesDB)
    }
    else
    {
        refreshListView()
    }
} // refreshSigsDB

//*****
void timeComboCB(DBE x)
// DESCRIPTION : Callback for the time-zone selection combo
// RETURNS : void
{
    refreshListView()
}

//*****
void sigDeselectCB(DBE x, int selectedEntry)
// DESCRIPTION : Deselect callback for listView - null-op.
// RETURNS : void
{
}

//*****
void sigSelectCB(DBE x, int selectedEntry)
// DESCRIPTION : Selection callback for signatures list
// RETURNS : void
{
    int indexScan = 0
    SignatureEntry sigEntry
    for sigEntry in signatureInfo do
    {

```

```

        if (indexScan == selectedEntry)
        {
            set (commentText, getComment (sigEntry))
            set (labelList, getLabelOptions (sigEntry))
            break
        }
        indexScan++
    }
} // sigSelectCB

// DEFINE MAIN DIALOG
sigListView = listView(signaturesDB, 0, 405, 8, dummy)
set (sigListView, sigSelectCB, sigDeselectCB, sigSelectCB)
timeCombo=choice(signaturesDB, "Display time at", timeChoices, 0, 9, false)
set (timeCombo, timeComboCB)
beside signaturesDB
timeLabel = label(signaturesDB, "location.")
below signaturesDB
commentText = text(signaturesDB, "Comments:", "", 100, 100, true)
labelList = text(signaturesDB, "Available labels:", "", 160, 100, true)

// BUTTONS
close (signaturesDB, true, closeDB)

realize signaturesDB
insertColumn (sigListView, SIGNATORY_COL, "Signatory", 150, iconNone)
insertColumn (sigListView, DATE_COL, "Date / Time", 150, iconNone)
insertColumn (sigListView, LABEL_COL, "Label", 100, iconNone)

refreshSigsDB ()
show signaturesDB

```

## Chapter 18

# Objects

This chapter describes features that operate on Rational DOORS objects:

- About objects
- Object access controls
- Finding objects
- Current object
- Navigation from an object
- Object management
- Information about objects
- Selecting objects
- Object searching
- Miscellaneous object functions

---

## About objects

Functions manipulate Rational DOORS objects via the `Object` data type. An important property of a Rational DOORS formal module is that the objects within the module are structured as a tree; the functions for creating and navigating objects therefore use the following tree terminology:

<b>parent</b>	the object immediately above an object
<b>child</b>	any object immediately below an object
<b>sibling</b>	any object that shares a parent with another object

Object DXL can be found in nearly every example DXL program given in this manual or in the DXL library.

---

## Object access controls

This section describes functions that report on access rights for an object. For all except the `canRead(object)` function, the module must be open for exclusive edit.

---

**canCreate(object)**

---

**Declaration**

```
bool canCreate(Object o)
```

**Operation**

Returns `true` if the current Rational DOORS user has create access to object `o`; otherwise, returns `false`.

---

---

**canControl(object)**

---

**Declaration**

```
bool canControl(Object o)
```

**Operation**

Returns `true` if the current Rational DOORS user can change the access controls on object `o`; otherwise, returns `false`.

---

---

**canRead(object)**

---

**Declaration**

```
bool canRead(Object o)
```

**Operation**

Returns `true` if the current Rational DOORS user can read object `o`; otherwise, returns `false`.

---

---

**canModify(object)**

---

**Declaration**

```
bool canModify(Object o)
```

**Operation**

Returns `true` if the current Rational DOORS user can modify object `o`; otherwise, returns `false`.

---

---

**canDelete(object)**

---

**Declaration**

```
bool canDelete(Object o)
```

**Operation**

Returns `true` if the current Rational DOORS user can delete object `o`; otherwise, returns `false`.

---



---

## canLock(object)

---

### Declaration

```
bool canLock(Object o)
```

### Operation

Returns `true` if the current Rational DOORS user can lock object `o`, which must be in a lockable section. It returns `false` for the following conditions:

- `o` is null
- `o` is contained within a module that is currently open read-only
- `o` is contained within a module that is currently open for exclusive edit
- `o` is not contained within a formal module
- the user does not have create or modify access to the object at the start of `o`'s editable section

---

## canUnlock(object)

---

### Declaration

```
bool canUnlock(Object o)
```

### Operation

Returns `true` if the current Rational DOORS user can unlock object `o`, which must be in a lockable section. It returns `false` for the following conditions:

- `o` is null
- `o` is contained within a module that is currently open read-only
- `o` is contained within a module that is currently open for exclusive edit
- `o` is not contained within a formal module
- the user does not currently have `o` locked

---

## Finding objects

This section defines functions that allow DXL programs to navigate through the objects in a module.

---

## object(absno)

---

### Declaration

```
Object object(int absno[, Module m])
```

## Operation

Returns the object with the specified absolute number. If no module argument is supplied, the current module is searched.

---

## all

---

This function is used in a `for` loop operating on modules, as shown in the following syntax:

```
all (Module module)
```

Returns a handle for *module* (see the `for object in all` loop).

---

## document

---

This function is used in a `for` loop operating on modules, as shown in the following syntax:

```
document (Module module)
```

Returns a handle for *module* (see the `for object in document` loop).

---

## entire

---

This function is used in a `for` loop operating on modules, as shown in the following syntax:

```
entire (Module module)
```

Returns a handle for *module* (see the `for object in entire` loop).

---

## module(containing object)

---

### Declaration

```
Module module (Object o)
```

### Operation

Returns the module that contains object *o*.

---

## top

---

This function is used in `for` loops operating on projects and modules, as shown in the following syntax:

```
top (Module module)
```

Returns a handle for *module* (see the loops `for history record in type` and `for object in top`).

---

---

## for object in all

---

### Syntax

```
for o in all(module) do {
  ...
}
```

where:

*o* is a variable of type Object

*module* is a variable of type Module

### Operation

Assigns the variable *o* to be each successive object in *module*. It includes table and row header objects and the cells, unless a filter is defined.

This loop respects the current display set; an object is only returned if it is displayed under the current filter, level setting, and so on. However, table header objects are always accounted for, even if the table is not visible in the current display due to a filter.

Deleted objects are included when they are visible and excluded when they are not visible. This is the case for all deleted objects except deleted table header objects, which are always displayed. Object numbering depends on whether deleted objects are displayed. If they are displayed, they are numbered. If they are not displayed, they are not numbered.

### Example

```
Object o
for o in all current Module do {
  print identifier o "\n"
}
```

---

## for object in entire

---

### Syntax

```
for o in entire(module) do {
  ...
}
```

where:

*o* is a variable of type Object

*module* is a variable of type Module

## Operation

Assigns the variable *o* to be each successive object in *module* regardless of its deleted state or the current display set. It includes table and row header objects and the cells.

---

### for object in document

---

#### Syntax

```
for o in document(module) do {
  ...
}
```

where:

*o* is a variable of type Object  
*module* is a variable of type Module

#### Operation

Assigns the variable *o* to be each successive object in *module*. It is equivalent to the `for object in module` loop, except that it includes table header objects, but not the row header objects nor cells.

#### Example

```
Object o
for o in document current Module do {
  print identifier o "\n"
}
```

---

### for object in module

---

#### Syntax

```
for o in module do {
  ...
}
```

where:

*o* is a variable of type Object  
*module* is a variable of type Module

#### Operation

Assigns the variable *o* to be each successive object in *module* in depth first order, including the cells only of any Rational DOORS native tables. Depth first order is the order in which objects are displayed down the page in a formal module.

This loop respects the current display set; an object is only returned if it is displayed under the current filter, level setting, and so on. Deleted objects are included when they are displayed and excluded when they are not displayed. Object numbering depends on whether deleted objects are displayed. If they are displayed, they are numbered. If they are not displayed, they are not numbered.

### Example

```
Object o
for o in (current Module) do
    print (o."Object Heading") "\n"
```

## for object in object

### Syntax

```
for o in parent do {
    ...
}
```

where:

<i>o</i>	is a variable of type Object
<i>parent</i>	is an object of type Object

Assigns *o* to each successive child of object *parent*.

This loop ignores filters, such that even if objects are filtered, they are still returned by this function. Deleted objects are included when they are displayed and excluded when they are not displayed.

### Example

```
Object o
Object po = current
for o in po do {
    print (o."Object Heading") " is a child of "
    print (po."Object Heading") "\n"
}
```

## for object in top

### Syntax

```
for o in top(module) do {
    ...
}
```

where:

- `o` is a variable of type `Object`
- `module` is a variable of type `Module`

Assigns `o` to each successive top-level object in `module`, including table headers. Top-level objects are those at level 1.

This function accesses all top level objects regardless of the current display set, which is different from the `for object in module` loop. Deleted objects are included, if they are displayed. Object numbering depends on whether deleted objects are displayed. If they are displayed, they are numbered. If they are not displayed, they are not numbered.

### Example

```
Object o
Module m = current
for o in top m do {
    print o."Created On" "\n"
}
```

---

## Current object

This section defines functions that are concerned with getting or setting the current object in a Rational DOORS module.

---

### Setting current object

---

The assignment operator `=` can be used as shown in the following syntax:

```
current = Object object
```

Makes *object* the current object. See also, the `current(object)` function.

For large DXL programs, when you set the current object, cast the current on the left hand side of the assignment to the correct type. This speeds up the parsing of the DXL program, so when your program is first run, it is loaded into memory quicker. It does not affect the subsequent execution of your program. So:

```
current = newCurrentObject
```

becomes

```
(current ObjectRef__) = newCurrentObject
```

Note that this cast only works for assignments to `current`. It is not useful for comparisons or getting the value of the current object.

### Example

```
current = first current Module
current = below current
```

```
current = create last below current
```

---

## current(object)

---

### Declaration

```
Object current([Module m])
```

### Operation

Returns a reference to the current object of module *m*, or the current module if *m* is omitted.

### Example

```
Object o = current
Module m = edit "Car user reqts"
Object o = current m
```

---

## Navigation from an object

This section defines functions that allow navigation across a Rational DOORS module relative to a given object.

---

### Specific object

---

The index notation, [ ], can be used to find a specific object, as shown in the following syntax:

```
Object o[int n]
Module m[int n]
```

This returns the *n*th child of object *o* counting from 1, or the *n*th top-level child of module *m*, counting from 1.

---

### gotoObject

---

### Declaration

```
Object gotoObject(int absno, Module m)
```

### Operation

Changes the display of the specified module so that the object with the specified absolute number is brought into the display, and made current. This perm will change the current view in order to ensure that this object can be displayed.

Returns the Object with that absolute number.

---

## Vertical navigation

---

### Declaration

```
Object first(Object o)
Object last(Object o)
Object next(Object o)
Object parent(Object o)
Object previous(Object o)
Object first(Module m)
Object last(Module m)
```

### Operation

The first five functions take an object argument *o*, and return an object, which is the object in the position relative to *o* as stated by the function:

<code>first</code>	returns the first child of object <i>o</i>
<code>last</code>	returns the last child of object <i>o</i>
<code>parent</code>	returns the parent of object <i>o</i>
<code>previous</code>	returns the previous object from object <i>o</i> in a depth first tree search (the same order as for <i>o</i> in <i>module</i> do)
<code>next</code>	returns the next object from object <i>o</i> in a depth first tree search (the same order as for <i>o</i> in <i>module</i> do)

If navigation is attempted to somewhere where no object exists, returns null.

These functions are used for vertical navigation of a Rational DOORS module.

The last two functions return the first and last objects of module *m* in a depth first tree search, that is the first and last objects as they appear in a displayed module.

### Example

This example finds objects relative to the passed object argument:

```
Object o = current
Object co = first o
if (null co) {
    print "Current object has no children.\n"
} else {
    if ((last o) == co) {
        print "current has one child: " (o."Object
            Heading") "\n"
```



```

        print (identifier o) " == " (identifier
            parent co) "\n"
    }
}
if (null o[3])
    print "current object does not have 3rd
        child\n"
if (null previous o)
    print "Current object is first in module.\n"
if (null next o)
    print "Current object is last in module.\n"
if (!null next o) {
    Object here = previous next o
    print (identifier o) " and " (identifier
        here) " are the same\n"
}

```

This example finds objects in the current module:

```

Object o1 = first current Module
Object o2 = last current Module
int count=1
while (o1 != o2) {
    count++
    o1 = next o1
}
print count " objects displayed in module\n"
o1 = (current Module)[3]
// get 3rd top level object
print identifier o1

```

---

## Horizontal navigation

---

These functions are similar to the vertical navigation functions, but take as an argument a call to the function `sibling`, which returns a handle to allow navigation between sibling objects (children of the same parent).

### Declaration

```

Object first(sibling(Object o))
Object last(sibling(Object o))
Object next(sibling(Object o))
Object previous(sibling(Object o))

```

## Operation

These functions return an object at the current level of hierarchy: `first_sibling` and `last_sibling` return the first and last objects. Function `first_sibling` works with the current display set, so hierarchies might disappear as the display set changes during navigation.

The functions are used for horizontal navigation of a Rational DOORS module.

## Example

```
Object o = current
Object po = parent o
if ((null previous_sibling o) &&
    (null next_sibling o)) {
    print (o."Object Heading") " is the only
        child of " // -(po."Object Heading") "\n"
    print "and " (identifier first_sibling o) "
        == " //- (identifier first_sibling o) " ==
        " (identifier o) "\n"
}
```

---

## Object management

This section defines the functions for creating, moving and deleting objects.

**Note:** The creation of tables, table rows, columns and cells is handled by special-purpose functions, which are described in “Tables,” on page 813.

---

### create(object)

---

#### Declaration

```
Object create(Module m)
Object create(Object o)
Object create(after(Object o))
Object create(before(Object o))
Object create(below(Object o))
Object create(first(below(Object o)))
Object create(last(below(Object o)))
```

## Operation

These functions create an object, whose position is controlled by the argument passed to the function, as follows:

Argument syntax	New object is
Module <i>m</i>	The first object in module <i>m</i> ; any existing objects at level 1 are moved after the new object
Object <i>o</i>	At the same level and immediately after the object <i>o</i>
<code>after (Object <i>o</i>)</code>	At the same level and immediately after the object <i>o</i> (same as without <code>after</code> )
<code>below (Object <i>o</i>)</code>	The first child of object <i>o</i>
<code>first (below (Object <i>o</i>))</code>	The first child of object <i>o</i> (same as without <code>first</code> )
<code>last (below (Object <i>o</i>))</code>	The last child of object <i>o</i>

In each case, the function returns the created object.

### Example

This example creates `newo` at the same level and immediately after `o`.

```
Object o = current
Object newo = create o
```

which is equivalent to:

```
Object o = current
Object newo = create after o
```

This example creates `newo` at the same level and immediately before `o`.

```
Object o = current
Object newo = create before o
```

This example creates `newo` as the first child of `o`.

```
Object o = current
Object newo = create below o
```

which is equivalent to:

```
Object o = current
Object newo = create first below o
```

This example creates `newo` as the last child of `o`.

```
Object o = current
o = create last below o
```

---

## move(object)

---

### Declaration

```
void move(Object o1,
          Object o2)

void move(Object o1,
          below(Object o2))

void move(Object o1,
          last(below(Object o2)))
```

### Operation

These functions move an object to a position, which is controlled by the second argument passed to the function, as follows:

Argument syntax	Moves
Object o2	object o1 and its descendants to be immediately after object o2
below(Object o2)	object o1 and its descendants to be the first child below o2
last(below(Object o2))	object o1 and its descendants to be the last child below o2

### Example

This example moves the last object in the module to be the first child of the first object:

```
Object p = first current Module
Object o = last current Module
move(o, below p)
```

This example moves the last object in the module to be the last child of the first object:

```
Object p = first current Module
Object o = last current Module
move(o, last below p)
```

---

## canDelete

---

### Declaration

```
string canDelete(Object o)
```

## Operation

Returns `null` if object `o` can be deleted; otherwise returns a string "object has descendants". The `softDelete(object)` function works on an object that has descendants.

## flushDeletions

### Declaration

```
void flushDeletions()
```

### Operation

Flushes any deletions performed by a DXL program. Normally Rational DOORS structures are only marked for deletion when the DXL program exits; this command makes any pending deletions happen immediately. Do not flush deletions inside a `for` loop, because the loop might depend on the presence of an object.

## hardDelete(object)

### Declaration

```
void hardDelete(Object o)
```

```
void delete(Object o)
```

### Operation

Removes object `o`; the object cannot be recovered with `undelete` following this operation. If the operation fails, returns an error message (see also the `canDelete` function).

The form `delete` is provided for backwards compatibility only. The function `hardDelete` should be used for all new programs.

## sectionNeedsSaved

### Declaration

```
bool sectionNeedsSaved(Object o)
```

### Operation

Returns `true` if `o` is contained within an object hierarchy that has been modified but not saved. Otherwise, returns `false`.

## softDelete(object)

### Declaration

```
void softDelete(Object o[, bool checkLinks])
```

## Operation

Marks object as deleted. The object is not actually deleted until it is purged. Objects marked for deletion can be recovered using the `undelete(object)` function. If the optional argument `checkLinks` is set to true, then an error will be given if any of the objects children have incoming links.

---

### undelete(object)

---

#### Declaration

```
string undelete(Object o)
```

#### Operation

Restores object *o*. On success returns null. On error, the error condition is returned to the user.

---

### purgeObjects\_

---

#### Declaration

```
string purgeObjects_(Module mod)
```

#### Operation

Removes all soft deleted objects from module *mod*. Once executed, these objects cannot be recovered. The name ends in '\_' to discourage casual use.

---

### purgeObject\_

---

#### Declaration

```
string purgeObject_(Object o)
```

#### Operation

Removes the specified soft-deleted object. Once executed, this object cannot be recovered. The name ends in '\_' to discourage casual use.

---

## Information about objects

This section defines functions that return information about objects.

---

## Object status

---

### Declaration

```
bool canRead(Object o)
bool canWrite(Object o)
bool leaf(Object o)
bool isDeleted(Object o)
bool isFiltered(Object o)
bool isOutline(Object o)
bool isSelected(Object o)
bool isVisible(Object o)
bool modified(Object o)
```

### Operation

Each function returns `true` for a condition that is defined by the function name:

Function	Returns true if
<code>canRead</code>	the user has read access to object <code>o</code>
<code>canWrite</code>	the user has write access to object <code>o</code>
<code>leaf</code>	object <code>o</code> has no children, or has children objects that are deleted, but not displayed
<code>isDeleted</code>	object <code>o</code> has been soft deleted
<code>isFiltered</code>	object <code>o</code> is accepted in the current filter
<code>isOutline</code>	object <code>o</code> would appear in outline mode
<code>isSelected</code>	object <code>o</code> is selected
<code>isVisible</code>	object <code>o</code> is part of the current display set
<code>modified</code>	object <code>o</code> has been modified since the last baseline of the module

---



---

## getColumnBottom

---

### Declaration

```
Object getColumnBottom(Object o)
```

## Operation

Returns the bottom cell of the table column that contains `o`; otherwise, returns `null`.

## getColumnTop

### Declaration

```
Object getColumnTop(Object o)
```

### Operation

Returns the top cell of the table column that contains `o`; otherwise, returns `null`.

## level(object get)

### Declaration

```
int level(Object o)
```

### Operation

Returns the object level of object `o`. Level 1 is the top level of the module.

## identifier

### Declaration

```
string identifier(Object o)
```

### Operation

Returns the identifier, which is a combination of absolute number and module prefix, of object `o` as a string.

## number

### Declaration

```
string number(Object o)
```

### Operation

Returns the hierarchical object number (for example `2.1.1-0.1`) of object `o` as a string.

## Selecting objects

This section defines functions concerned with selecting objects.



---

## getSelection

---

### Declaration

```
Object getSelection(Module m)  
void getSelection(Module m,  
                  Object &start,  
                  Object &finish)
```

### Operation

The first form gets the first object of a selection in module *m*.

The second form gets the current selection in module *m*, and sets object variables *start* and *finish* to the beginning and end of it.

The start and end objects must be siblings.

---

## setSelection

---

### Declaration

```
void setSelection(Object o)  
void setSelection(Object start,  
                  Object finish)
```

### Operation

The first form makes object *o* the start and finish of the current selection.

The second form sets the selection in the current module to begin at object *start* and end at object *finish*.

The start and end objects must be siblings.

---

## deselect

---

### Declaration

```
void deselect(Object o)  
void deselect(Module m)
```

### Operation

Deselects object *o* or the current selection in module *m*.

---

## Object searching

This section defines functions that are used by Find/Replace when highlighting an object, or an object's attribute.

---

### setSearchObject

---

#### Declaration

```
void setSearchObject(Object, int columnIndex)
```

#### Operation

Used by Find/Replace to mark either a specific attribute of the object in a column by surrounding it in a colored box (the same color as an outgoing link). This indicates which specific part of the object has been matched by the find operation. If no valid/visible column is supplied, the object is marked by lines above and below the entire object.

#### Example

```
Object o = object(4)
int mainColumn = 1
setSearchObject(o, mainColumn)
```

---

### getSearchObject

---

#### Declaration

```
Object getSearchObject(Module, int &columnIndex)
```

#### Operation

Returns the object and column number of the highlighted attribute in the given module.

#### Example

```
Module m = current
int col
Object o = getSearchObject(m, col)
```

---

### clearSearchObject

---

#### Declaration

```
void clearSearchObject(Object)
void clearSearchObject(Module)
```

## Operation

Clears the highlighting put in place by `setSearchObject`. Currently, if an object is provided, that object need not be the highlighted object, but this could change.

## Example

```
Object o = current
clearSearchObject(o)
```

## highlightText

### Declaration

```
bool highlightText(Object, int start, int stop, int colIndex, bool isHeading)
```

### Operation

Highlights text in the given module, in the given column from cursor position *start* to cursor position *stop*.

### Example

```
//Highlights the first 10 characters of the current objects heading
highlightText(current Object, 10, 20, 1, true)
```

## getInPlaceColumnIndex

### Declaration

```
int getInPlaceColumnIndex(Module)
```

### Operation

Returns the column index where in-place editing is taking place.

## Miscellaneous object functions

This section defines functions that affect the display of an object or use the clipboard.

## inplaceEditing

### Declaration

```
bool inplaceEditing(Module m)
```

## Operation

This returns `true` if the module *m* is a formal module which is currently displayed and in-place edit mode is activated for a displayed attribute.

## object

### Declaration

```
Object object(int i[,Module m])
```

### Operation

Returns the object with the specified absolute number. If no `Module` argument is supplied, the current module is searched.

### Example

```
Object o = object(4)
print identifier o
```

## Clipboard general functions

### Declaration

```
bool cut()
bool copyFlat()
bool copyHier()
bool pasteSame()
bool pasteDown()
bool clearClipboard()
bool clipboardIsEmpty()
bool clipboardIsTransient()
```

### Operation

Each function performs an action or status check defined by the function name as follows:

Function	Action
<code>cut</code>	Cuts the current object and all of its children, and stores them on the clipboard. If the operation succeeds, returns <code>true</code> ; otherwise, returns <code>false</code> .
<code>copyFlat</code>	Copies the current object to the clipboard. If the operation succeeds, returns <code>true</code> ; otherwise, returns <code>false</code> .

Function	Action
<code>copyHier</code>	Copies the current object and all of its children to the clipboard. If the operation succeeds, returns <code>true</code> ; otherwise, returns <code>false</code> .
<code>pasteSame</code>	Pastes the clipboard contents after the current object, at the same level as the current object. If the operation succeeds, returns <code>true</code> ; otherwise, returns <code>false</code> .
<code>pasteDown</code>	Pastes the clipboard contents one level down from the current object. If the operation succeeds, returns <code>true</code> ; otherwise, returns <code>false</code> .
<code>clearClipboard</code>	Clears the clipboard. If the operation succeeds, returns <code>true</code> ; otherwise, returns <code>false</code> . The Rational DOORS object clipboard is also cleared when a module is closed.
<code>clipboardIsEmpty</code>	Returns <code>true</code> if the clipboard is empty. Returns <code>false</code> if the clipboard is not empty.
<code>clipboardIsTransient</code>	Returns <code>true</code> if the clipboard contains transient data (the result of a cut or copy operation). Returns <code>false</code> if the clipboard does not contain transient data.

---

## splitHeadingAndText

---

### Declaration

```
string splitHeadingAndText (Object)
```

### Operation

Splits the Object Heading and Object Text of the given object. The heading will be moved to a new object, and the heading of the given object will be emptied. The given object will be demoted to become the first child of the new object. Returns a null string on success or an error message on failure.

### Example

```
Object o = current
string s = splitHeadingAndText (o)
if (null s){
    print "Object split successfully."
} else {
    print "Error splitting object : " s
}
}
```

---

## getCursorPosition

---

### Declaration

```
int getCursorPosition(Module, bool &isHeading)
```

### Operation

If no attributes in the given module are activated for in-place editing then -1 is returned. Otherwise it returns the position of the cursor in the attribute currently being edited, if that attribute is the Object Heading then `isHeading` will be set to true, otherwise it will be set to false.

### Example

```
bool isHeading
print getCursorPosition(current Module, isHeading) ""
```

## Chapter 19

# Links

This chapter describes features that operate on Rational DOORS links:

- About links and link module descriptors
- Link creation
- Link access control
- Finding links
- Versioned links
- Link management
- Default link module
- Linksets
- External Links
- OSLC Link Discovery
- Rational DOORS URLs

---

## About links and link module descriptors

The underlying database architecture of Rational DOORS links affects the way in which link DXL must be written. Link modules store linksets, not actual links. Link modules can be placed in any folder in the hierarchy except the database root folder, but they are normally placed in the folder containing the source module.

Links are stored in the module corresponding to the source of the link. This means that the user must have write permission in the source module to create or modify a link.

This causes an asymmetry in DXL programs that handle links. Any code trying to access an incoming link must have the source module loaded. Outgoing links are always immediately available in a formal module. However, the `target` module might not be open, in which case the `target` function returns `null`.

Rational DOORS links are represented in DXL in by the `Link` data type.

A folder or project can specify the link modules to be used when a link is created between a pair of modules, the source of which is in the folder. This source/target module pairing is called a link module descriptor, which is represented by the `LinkModuleDescriptor` data type.

**Note:** To obtain a type `LinkModuleDescriptor` handle, you must use the `for link module descriptor in folder loop`.

Each pairing contains the name of the link module, a description, and a boolean flag *overridable*. The *overridable* flag specifies whether that link module must be used for links between the specified source and target module. If *overridable* is *false*, newly created links must be in that link module; specifying a different link module at the time a link is created causes a run-time error. If *overridable* is *true*, you can specify a different link module. The modules referenced in the link module descriptor might but need not already exist at the time the link module is specified.

---

## Link creation

This section defines the operators used to create links.

---

### Link operators

---

Two operators create links, as shown in the following syntax:

```
Object source -> [string linkModuleName ->] Object target
```

```
Object target <- [string linkModuleName <-] Object source
```

The `->` operator creates an outgoing link from object *source* to object *target* via link module *linkModuleName*. If *linkModuleName* is omitted the link goes via the default link module (see “Default link module,” on page 410).

The `<-` operator creates an incoming link from object *source* to object *target* via link module *linkModuleName*. If *linkModuleName* is omitted the link goes via the default link module.

These operators are also used in the for loops defined in “Finding links,” on page 395.

### Example

This example creates a link from the current object of the current module to the first object of module *target* via the link module *tested by*.

```
(current Object) -> "tested by" -> (first read "target")
```

This example creates a link to the current object of the current module from the first object of module *source* via the link module *tested by*. Because links are stored in the source module, you must open *source* for editing to allow the link to be created.

```
(current Object) <- "tested by" <- (first edit "source")
```

---

## Link access control

This section describes a function that reports on access rights for links.



---

## canDelete(link)

---

### Declaration

```
bool canDelete(Link l)
string canDelete(Link l)
```

### Operation

The first form returns `true` if the current Rational DOORS user can delete link `l`. Otherwise, returns `false`.

The second form returns a null string if the current Rational DOORS user can delete link `l`. Otherwise, it returns an error message.

---

## Finding links

This section defines `for` loops that allow DXL programs to navigate through the links in a module. Links are referred to by the `Link` or `LinkRef` data type.

---

### for all outgoing links

---

#### Syntax

```
for outLink in (Object srcObject) -> (string
    linkModuleName) do {
    ...
}
```

where:

<i>outLink</i>	is a variable of type <code>Link</code>
<i>srcObject</i>	is a variable of type <code>Object</code>
<i>linkModuleName</i>	is a string variable

#### Operation

Assigns the variable `outLink` to be each successive outgoing link from object `srcObject` via link module named `linkModuleName`. The string `linkModuleName` can be a specific link module name, or the string `"*"` meaning any link module.

#### Example

```
Link l
```

```
for l in (current Object) -> "*" do {
  string user = l."Created By"
  print user "\n"
}
```

---

## for all incoming links

---

### Syntax

```
for inLink in (Object tgtObject) <- (string
  linkModuleName) do {
  ...
}
```

where:

<i>inLink</i>	is a variable of type Link or LinkRef
<i>tgtObject</i>	is a variable of type Object
<i>linkModuleName</i>	is a string variable

### Operation

Assigns the variable *inLink* to be each successive incoming link arriving at object *tgtObject* via link module named *linkModuleName*. The string *linkModuleName* can be a specific link module name, or the string "\*" meaning any link module.

**Note:** This loop only assigns to *inLink* incoming link values for which the source object is loaded; unloaded links are not detected.

### Example

Link l

```
for l in (current Object) <- "*" do {
  string user = l."Created By"
  print user "\n"
}
```

---

## for each incoming link

---

### Syntax

```
for LinkRef in each(Object tgtObject) <- (string
  linkModuleName) do {
  ...
}
```

where:

*LinkRef* is a variable of type `Link` or `LinkRef`  
*tgtObject* is a variable of type `Object`  
*linkModuleName* is a string variable

## Operation

Assigns the variable *LinkRef* to be each successive incoming link arriving at object *tgtObject* via link module named *linkModuleName*. The string *linkModuleName* can be a specific link module name, or the string "\*" meaning any link module.

Iterates through all incoming link references including those from baselines and soft-deleted modules.

**Note:** This loop only assigns to *LinkRef* incoming link values for which the source object is loaded; unloaded links are not detected.

## Example

```
LinkRef l
for l in each(current Object) <- "*" do {
    string user = l."Created By"
    print user "\n"
}
```

---

## for all sources

---

### Syntax

```
for srcModName in (Object tgtObject) <- (string
    linkModName) do {
    ...
}
```

where:

*srcModName* is a string variable  
*tgtObject* is a variable of type `Object`  
*linkModName* is a string variable

### Operation

Assigns the variable *srcModName* to be the unqualified name of the source module of each successive incoming link arriving at object *tgtObject* via link module named *linkModuleName*. The string *linkModuleName* can be a specific link module name, or the string "\*" meaning any link module.

**Note:** This loop assigns to *modName* values for all incoming links, whether the source is loaded or not. This can be used to pre-load all incoming link sources before using the `for all incoming links` loop.

## Example

This example prints the unqualified name of all the source modules for incoming links to the current object:

```
Object o = current
string srcModName
for srcModName in o<-"*" do print srcModName "\n"
```

## for each source

### Syntax

```
for srcModName in each(Object tgtObject) <- (string
    linkModuleName) do {
    ...
}
```

where:

<i>srcModName</i>	is a string variable
<i>tgtObject</i>	is a variable of type Object
<i>linkModuleName</i>	is a string variable

### Operation

Assigns the variable *srcModName* to be the unqualified name of the source module of each successive incoming link arriving at object *tgtObject* via link module named *linkModuleName*. The string *linkModuleName* can be a specific link module name, or the string "\*" meaning any link module.

Includes links from baselines and soft-deleted modules, returning the name of the source module (without baseline version numbers).

**Note:** This loop assigns to *modName* values for all incoming links, whether the source is loaded or not. This can be used to pre-load all incoming link sources before using the `for all incoming links` loop.

### Example

This example prints the unqualified name of all the source modules for incoming links to the current object:

```
Object o = current
string srcModName
for srcModName in each o<-"*" do print srcModName "\n"
```

---

## for all source references

---

### Syntax

```
for srcModRef in (Object tgtObject) <- (string
    linkModName) do {
    ...
}
```

where:

<i>srcModRef</i>	is a variable of type <code>ModName_</code>
<i>tgtObject</i>	is a variable of type <code>Object</code>
<i>linkModName</i>	is a string variable

### Operation

Assigns the variable *srcModRef* to be the reference of the source module of each successive incoming link arriving at object *tgtObject* via link module named *linkModuleName*. The string *linkModuleName* can be a specific link module name, or the string "\*" meaning any link module.

**Note:** This loop assigns to *modName* values for all incoming links, whether the source is loaded or not. This can be used to pre-load all incoming link sources before using the `for all incoming links` loop.

### Example

```
ModName_ srcModRef
for srcModRef in o<-"*" do
    read(fullName(srcModRef), false)
```

---

## for each source reference

---

### Syntax

```
for srcModRef in each(Object tgtObject) <- (string
    linkModName) do {
    ...
}
```

where:

<i>srcModRef</i>	is a variable of type <code>ModName_</code>
<i>tgtObject</i>	is a variable of type <code>Object</code>
<i>linkModName</i>	is a string variable

## Operation

Assigns the variable *srcModRef* to be the reference of the source module of each successive incoming link arriving at object *tgtObject* via link module named *linkModuleName*. The string *linkModuleName* can be a specific link module name, or the string "\*" meaning any link module.

Includes links from baselines and soft-deleted modules.

**Note:** This loop assigns to *modName* values for all incoming links, whether the source is loaded or not. This can be used to pre-load all incoming link sources before using the `for all incoming links` loop.

## Example

```
ModName_ srcModRef
for srcModRef in each o<-"*" do
    read(fullName(srcModRef), false)
```

## for all link references

### Syntax

```
for linkRef in (Object tgtObject) <- (string
    linkModuleName) do {
    ...
}
```

where:

<i>linkRef</i>	is a variable of type LinkRef
<i>tgtObject</i>	is a variable of type Object
<i>linkModuleName</i>	is a string variable

### Operation

Assigns the variable *linkRef* to be the link reference of each successive incoming link arriving at object *tgtObject* via link module named *linkModuleName*. The string *linkModuleName* can be a specific link module name, or the string "\*" meaning any link module.

## for link module descriptor in folder

### Syntax

```
for linkModDesc in f do {
    ...
}
```

where:

*linkModDesc* is a variable of type `LinkModuleDescriptor`

*f* is a variable of type `Folder`

## Operation

Assigns the variable *linkModDesc* to be each successive link module descriptor in folder *f*.

# Versioned links

## for all outgoing links

### Declaration

```
for outLink in all (Object srcObject) -> (string linkModName) do {
    ...
}
```

where:

*outLink* is a variable of type `Link`

*srcObject* is a variable of type `Object`

*linkModName* is a variable of type `string`

### Operation

This will iterate through all outgoing links, including links to baselines.

## for all incoming links

### Declaration

```
for inLink in all ((Object tgtObject) <- (string linkModuleName)) do {
    ...
}
```

where:

*inLink* is a variable of type `Link` or `LinkRef`

*tgtObject* is a variable of type `Object`

*linkModuleName* is a string variable

## Operation

These will iterate through all incoming links, including links from baselines.

### for all source links

#### Declaration

```
for srcModName in (Object tgtObject) <- (string linkModName) do {
  ...
}
```

where:

*srcModName* is a string variable

*tgtObject* is a variable of type Object

*linkModName* is a string variable

This would include links from baselines, returning the name of the source module, without baseline version numbers.

### for all source link references

#### Declaration

```
for srcModRef in (Object tgtObject) <- (string linkModName) do {
  ...
}
```

where:

*srcModRef* is a variable of type ModName\_

*tgtObject* is a variable of type Object

*linkModName* is a string variable

## Operation

This would include links from baselines.



---

## sourceVersion

---

### Declaration

```
ModuleVersion sourceVersion(Link|LinkRef l)
```

### Operation

This will return document version information for the source module of the specified `Link` or `LinkRef`. The new `ModuleVersion` type gives access to `ModName_` and `Baseline` information, via new perms detailed in the rest of this section.

---

## targetVersion

---

### Declaration

```
ModuleVersion targetVersion(Link l)
```

### Operation

This will return document version information for the target module of the specified `Link`.

---

## echoed outlinks

---

### Declaration

```
bool echo(Link l)
```

### Operation

This returns `true` for an echoed outlink. An echoed outlink is any outgoing link in a module baseline which does not have a corresponding inlink in the target module leading back to this baseline. Any outgoing link in a baseline will be an echoed link unless it is a link to the same module or a link to another module in the same Baseline Set.

---

## echoed inlinks

---

### Declaration

```
bool echo(LinkRef l)
```

### Operation

This returns `true` for an echoed inlink. An echoed inlink is any incoming link in a module baseline which does not have a corresponding outlink in the source module leading back to this baseline. Any incoming link in a baseline will be an echoed link unless it is a link from the same module or a link from another module in the same Baseline Set.

---

## getSourceVersion(Linkset)

---

### Declaration

```
ModuleVersion getSourceVersion(Linkset ls)
```

### Operation

Returns some description of the version of the document in the source of a linkset *ls*.

---

## Link management

This section defines functions for managing links. Links are referred to by the `Link` or `LinkRef` data type.

---

## addLinkModuleDescriptor

---

### Declaration

```
string addLinkModuleDescriptor(Folder f,
                               string source,
                               string target,
                               bool overrideable,
                               [bool mandatory, ]
                               string linkmod,
                               string desc)
```

### Operation

Creates a new link module descriptor for the link between *source* and *target*, via link module *linkmod*, in folder *f*. If the link module does not exist when this function is called, *desc* is the description of the link module created. Folder *f* must be the folder that contains the module *source*.

If the operation succeeds, returns a null string; otherwise, returns an error message.

This function checks for duplicate *source/target* pairings. If the new link module descriptor would create a duplicate, it returns a message.

The *overrideable* parameter specifies whether the link module descriptor will be overrideable.

The optional *mandatory* parameter specifies whether the link module descriptor will be mandatory.

For further information on link module descriptors, see “About links and link module descriptors,” on page 393.

---

## removeLinkModuleDescriptor

---

### Declaration

```
string removeLinkModuleDescriptor(Folder f, string s, string t)
```

### Operation

Deletes one link module descriptor defined for source *s* and target *t*, in folder *f*. If there is more than one *s/t* pair, the duplicates remain.

If the operation succeeds, returns a null string; otherwise, returns an error message.

For further information on link module descriptors, see “About links and link module descriptors,” on page 393.

---

## setLinkModuleDescriptorsExclusive

---

### Declaration

```
void setLinkModuleDescriptorsExclusive(Folder f, ModName_ m, bool flag)
```

### Operation

Setting the boolean variable *flag* to true has the same effect as selecting the **only allow outgoing links as specified in the above list** option in the user interface.

### Example

```
Folder f = current
ModName_ m = module("/A Project/A Module")
setLinkModuleDescriptorsExclusive(f, m, true)
```

---

## getLinkModuleDescriptorsExclusive

---

### Declaration

```
bool getLinkModuleDescriptorsExclusive(Folder f, ModName_)
```

### Operation

Returns true if the **only allow outgoing links as specified in the above list** user interface option is set for the specified document. The specified document must be a child of the specified folder.

---

## getDescription

---

### Declaration

```
string getDescription(LinkModuleDescriptor linkModDesc)
```

## Operation

Returns the description of the link module in the specified link module descriptor.

If the operation succeeds, returns a string; otherwise, returns null.

For further information on link module descriptors, see “About links and link module descriptors,” on page 393.

## getName

### Declaration

```
string getName(LinkModuleDescriptor linkModDesc)
```

### Operation

Returns the name of the specified link module descriptor.

If the operation succeeds, returns a string; otherwise, returns null.

For further information on link module descriptors, see “About links and link module descriptors,” on page 393.

## getSourceName

### Declaration

```
string getSourceName(LinkModuleDescriptor linkModDesc)
```

### Operation

Returns the name of the source in the specified link module descriptor.

If the operation succeeds, returns a string; otherwise, returns null.

For further information on link module descriptors, see “About links and link module descriptors,” on page 393.

## getTargetName

### Declaration

```
string getTargetName(LinkModuleDescriptor linkModDesc)
```

### Operation

Returns the name of the target in the specified link module descriptor.

If the operation succeeds, returns a string; otherwise, returns null.

For further information on link module descriptors, see “About links and link module descriptors,” on page 393.

---

## getOverridable

---

### Declaration

```
bool getOverridable(LinkModuleDescriptor linkModDesc)
```

### Operation

Returns whether the specified link module descriptor is overridable.

If the operation fails, returns `null`.

For further information on link module descriptors, see “About links and link module descriptors,” on page 393.

---

## setOverridable

---

### Declaration

```
void setOverridable(LinkModuleDescriptor linkModDesc, bool overridable)
```

### Operation

If *overridable* is true, sets *linkModDesc* to overridable; otherwise sets *linkModDesc* to not overridable.

If *linkModDesc* is already overridable, the call fails. You can obtain the value of the override setting using the *getOverridable* function.

For further information on link module descriptors, see “About links and link module descriptors,” on page 393.

---

## getMandatory

---

### Declaration

```
bool getMandatory(LinkModuleDescriptor linkModDesc)
```

### Operation

Returns whether the specified link module descriptor is mandatory.

If the operation fails, returns `null`.

---

## setMandatory

---

### Declaration

```
void setMandatory(LinkModuleDescriptor linkModDesc, bool mandatory)
```

### Operation

If *mandatory* is true it sets *linkModDesc* to mandatory; otherwise sets *linkModDesc* to not mandatory.

If *linkModDesc* is already mandatory, the call fails.

---

## delete(link)

---

### Declaration

```
void delete(Link l)
```

### Operation

Marks link *l* for deletion. The delete only takes effect when the DXL script ends, or when the *flushDeletions* function is called.

---

## module(link)

---

### Declaration

```
Module module(Link l)
```

### Operation

Returns the link module handle of link *l*, where linksets are stored as objects.

---

## source

---

### Declaration

```
string source({Link|LinkRef} l)
ModName_ source({Link|LinkRef} l)
Object source(Link l)
```

### Operation

The first form returns the unqualified name of the module that is the source of *l*, which can be of type *Link* or *LinkRef*.

The second form returns a reference to the module that is the source of *l*, which can be of type *Link* or *LinkRef*.

The third form returns the source object of link *l*.

### Example

```
Object o = current
LinkRef lref
ModName_ srcModRef
for lref in o<-"*" do {
    srcModRef = source lref
    read(fullName(srcModRef), true)
}
```

---

## sourceAbsNo

---

### Declaration

```
int sourceAbsNo({Link|LinkRef} l)
```

### Operation

Returns the absolute number of the object that is the source of *l*, which can be of type *Link* or *LinkRef*.

---

## target

---

### Declaration

```
string target(Link l)
```

```
ModName_ target(Link l)
```

```
Object target(Link l)
```

### Operation

The first form returns the unqualified name of the module that is the target of link *l*.

The second form returns a reference to the module that is the target of link *l*.

The third form returns the target object of link *l*. Returns null if the target module is not loaded, in which case your program can load the module and re-run target.

### Example

```
Object o = current
Link lnk
ModName_ targetMod
for lnk in o->"*" do {
    targetMod = target lnk
    read(fullName(targetMod), true)
}
```

---

## targetAbsNo

---

### Declaration

```
int targetAbsNo(Link l)
```

### Operation

Returns the absolute number of the object that is the target of *l*.

---

## Default link module

This section defines functions that operate on the default link module, which is used by drag-and-drop operations from the Rational DOORS user interface.

---

### getDefaultLinkModule

---

#### Declaration

```
string getDefaultLinkModule([ModName_ srcRef,
                             ModName_ trgRef])
```

#### Operation

Returns the name of the default link module.

#### Example

```
print getDefaultLinkModule(module("Functional
    Requirements"),module("User Requirements"))
```

---

### setDefaultLinkModule

---

#### Declaration

```
void setDefaultLinkModule(string linkModName)
```

#### Operation

Sets the name of the default link module.

---

## Linksets

This section defines functions that apply to linksets. Linksets are referred to by the `Linkset` data type.

---

### create(linkset)

---

#### Declaration

```
Linkset create([Module linkMod,]
               string source,
               string target)
```



## Operation

Creates a linkset between modules specified by the strings *source* and *target*, in the link module *linkMod*. If *linkMod* is omitted, creates a linkset in the current module. If the link module is open for display, the display updates to show this linkset.

## delete(linkset)

### Declaration

```
void delete(Linkset ls)
```

### Operation

Deletes the linkset *ls*. If the linkset is currently being displayed, the link module resets to displaying no linkset.

## getSource getTarget

### Declaration

```
string getSource(Linkset ls,  
                Object &o)
```

```
string getTarget(Linkset ls,  
                Object &o)
```

### Operation

The first function gets the current source object in linkset *ls*, and sets object variable *o* to it.

The second function gets the current target object in linkset *ls*, and sets object variable *o* to it.

Either function returns null if it succeeds; otherwise, returns an error message.

## linkset

### Declaration

```
Linkset linkset(Object ls)
```

### Operation

Converts a link module's object *ls* into a linkset handle, which can be used with the operations `load` and `delete`.

### Example

In this example, *m* must be a link module, which means that the objects it contains are linksets. To make this explicit the function `linkset` is called.

```
Module m = current
```

```
Object o
```

```
Linkset ls = linkset o
```

```
delete ls
```

---

## load

---

### Declaration

```
string load(Linkset ls)
```

### Operation

Load the linkset *ls*. If the associated link module is open for display, the display updates to show this linkset.

---

## setSource, setTarget

---

### Declaration

```
string setSource(Linkset ls,
                 Object o)
string setTarget(Linkset ls,
                 Object o)
```

### Operation

Sets either the source or the target object in the linkset *ls*, as displayed in the link module window matrix view, to be object *o*. They depend on the module being visible.

If the operation succeeds, returns *null*; otherwise, returns an error message.

---

## side1

---

### Declaration

```
Object side1(Module linkMod)
```

### Operation

Returns the object that is currently selected on *side1* (the source side) of the linkset. Depends on the module being visible.

**Note:** When using this perm just after opening the module *linkMod*, the *refresh* perm should be used beforehand

---

## side2

---

### Declaration

```
Object side2(Module linkMod)
```

### Operation

Returns the object that is currently selected on *side2* (the target side) of the linkset. Depends on the module being visible.

**Note:** When using this perm just after opening the module `linkMod`, the `refresh` perm should be used beforehand

---

## unload

---

### Declaration

```
void unload(Linkset ls)
void unload(Module linkMod)
```

### Operation

Unloads a loaded linkset specified by either the linkset handle *ls*, if it is current, or the current linkset of the link module *linkMod*.

---

## getTargetModule

---

### Declaration

```
ModName_ getTarget(Linkset ls)
```

### Operation

Returns the target module reference for the specified linkset.

---

## External Links

---



---

### ExternalLink

---

`ExternalLink` is a new data type representing the end of an external link. An external link is a one way link to the resource it references. No corresponding link is created in the linked resource.

---

### ExternalLinkDirection

---

#### Declaration

```
ExternalLinkDirection extLinkDir
```

#### Operation

Used to describe the direction of an external link. Valid values are `inward` and `outward`.

---

## ExternalLinkBehavior

---

### Declaration

```
ExternalLinkBehaviour extLinkBeh
```

### Operation

Used to describe the behavior of an external link. Valid values are `none` and `openAsURL`.

---

## ExternalLink current

---

### Operation

Fetches the current external link. This perm will return non-null only when called from within attribute DXL executing against an external link. In all other cases it will be null.

### Example

```
External extLink = current
```

---

## create(external link)

---

### Declaration

```
string create(Object o,
              string description,
              string name,
              ExternalLinkDirection extLinkDir,
              ExternalLinkBehaviour extLinkBeh,
              string body,
              ExternalLink& extLink)
```

### Operation

Creates an external link on the specified object. The object must be locked and be modifiable by the current session. On success, null is returned and the new link is returned in the `ExternalLink&` variable.

---

## canDelete(external link)

---

### Declaration

```
bool canDelete(ExternalLink extLink)
string canDelete(ExternalLink extLink)
```

### Operation

This perm should always return `false`. If applied to a link from a baseline, an error string will be returned.

---

## source

---

### Declaration

```
Object source(ExternalLink extLink)
```

### Operation

Returns information concerning the object having this external link for external links marked as out. For external links marked as in, the perm returns null.

---

## for all outgoing external links

---

### Declaration

```
for extLink in (Object o) -> string ""
where:
  extLink is a variable of type ExternalLink
```

### Operation

Iterates over all external outgoing links on the object *o*. The supplied string parameter must be the empty string.

---

## for all incoming external links

---

### Declaration

```
for extLink in (Object o) <- string ""
where:
  extLink is a variable of type ExternalLink
```

### Operation

Iterates over all external incoming links on the object *o*. The supplied string parameter must be the empty string.

### Example

The following example demonstrates the external link behavior. It must be executed from within a module that has at least one object.

```
ExternalLink e1,e11,e12,e13
//Create 3 external links
print create(current Object, "Description1", "Name1", outward, none,
"https://www.ibm.com", e11)
print create(current Object, "Description2", "Name2", outward, openAsURL,
"https://www.ibm.com/software/support/", e12)
```

```

print create(current Object, "Description3", "Name3", inward, openAsURL,
"https://www.ibm.com/software/support", e13)

follow(e11) //This will fail - follow behavior is 'none'.
update("IBM Web Site",name(e11),direction(e11), openAsURL, body(e11), e11)
follow(e11)

Object o = current
//Iterate over outward links
for el in o->" do
{
    print "Created on " el."Created On" " Last modified on " el."Last Modified
On" "\n"
}

//Iterate over inward links - changing External Link data
for el in o<-" do
{
    string elName = name(el)
    string elDesc = description(el)
ExternalLinkDirection elDir = direction(el)
    ExternalLinkBehaviour elBehaviour= behaviour(el)
    string elBody = body(el)
    if (elBehaviour == none)
    {
        elName = "New name"
    }
    update(elDesc, elName, elDir, elBehaviour, elBody, el)
}

for el in o<-" do
{
    string elName = name(el)
    print "" elName "' created on " el."Created On" " Last modified on "
el."Last Modified On" "\n"
}

```

```

if (behaviour(el) == openAsURL)
{
    print "Opening up '" body(el) "' \n"
    print follow(el) "\n"
    update("IBM Support Web Site",name(el),direction(el), behaviour(el),
body(el), el)
    break
}
}

```

---

## OSLC Link Discovery

When OSLC (external) links are discovered the results are stored in DOORS in a database-wide cache so that future sessions that open modules with those links open faster. When a user opens a module, the cache is checked first for any external links. If the data in the cache has not yet expired then the cached external links are shown; else, a new query is executed to discover any OSLC (external) links and the cache is then updated with the results. The cache has a default expiry time of 5 minutes after which the external links are considered to be out of date. This expiry time can be modified.

---

### getCachedExternalLinkLifeTime

---

#### Declaration

```
int getCachedExternalLinkLifeTime()
```

#### Operation

Returns the life time (expiry time) of the cached external links in seconds.

---

### setCachedExternalLinkLifeTime

---

#### Declaration

```
string setCachedExternalLinkLifeTime(int lifetime)
```

#### Operation

Sets the life time (expiry time) of the cached external links to lifetime seconds.

If the value lifetime is zero then this will disable link discovery.

Returns an error if the user does not have the manage database privilege; otherwise, returns null.

---

## Rational DOORS URLs

---

### getURL

---

#### Declaration

```
string getURL(Database__ d)
string getURL(Module m)
string getURL(ModName_ modName)
string getURL(ModuleVersion modVer)
string getURL(Object o)
string getURL(Folder f)
string getURL(Project p)
string getURL(Item i)
```

#### Operation

Returns the Rational DOORS URL of the given parameter.

---

### decodeURL

---

#### Declaration

```
string decodeURL(string url, string& dbHost, int& dbPort, string& dbName,
string& dbId, Item& i, ModuleVersion& modVer, int& objectAbsno)
```

#### Operation

This perm decodes the given Rational DOORS URL and returns in its output parameters enough details to validate the URL *url* against the current database and navigate to the item or module specified by that URL.

The output Item *i* and ModuleVersion *modVer* will be null if the URL refers to the database root node.

The output ModuleVersion will be null if the URL refers to a project or folder.

The *objectAbsno* variable will be -1 unless the URL specifies navigation to a particular object.

The function returns null if the URL is successfully decoded, or an error string if the referenced Item cannot be found or the user does not have read access to the referenced Item.

This perm only works on legacy Rational DOORS URLs. This perm does not work when the re-director is enabled for Rational DOORS, for example when the URLs have been transformed using the **-urlPrefix** switch in **dbadmin**.

In this case, convert the URLs to legacy URLs using the perm `getLegacyURL()`.

#### Example



The following example demonstrates the Rational DOORS URL behavior. The current example returns the details for the current Object selected in a module. The second last line of the example can be changed to return details for the corresponding item.

```
string urlInfo(string url)

// DESCRIPTION: Returns a string describing the target of the specified URL
string.
{
    string result = null
    ModuleVersion mv
    int objectAbsno
    Item i

    string dbHost = null
    int dbPort
    string dbName
    string dbID = null

    result = decodeURL(url, dbHost, dbPort, dbName, dbID, i, mv, objectAbsno)

    if (null result)
    {
        if (dbID != getDatabaseIdentifier)
        {
            result = "The dbID does not match the current database."
        }
        else if (null i)
        {
            result = "Database: " dbName ""
        }
        else if (null mv)
        {
            // we're going to the top level node
            result = (type i) ": " (fullName i) ": " (description i)
        }
    }
}
```

```

else
{
    // it's a module or baseline
    Module m = null

    if (isBaseline(mv))
    {
        result = "Baseline: " (fullName mv) " [" (versionString mv) "]:
" (description module mv)
    }
    else
    {
        result = "Module: " (fullName mv) ": " (description module mv)
    }

    if (objectAbsno >= 0)
    {
        if (isBaseline(mv))
        {
            m = load(mv, true)
        }
        else
        {
            string mode = getenv("DOORSDEFOPENMODE")
            if (mode == "READ_ONLY" || mode == "r")
            {
                m = read(fullName(mv))
            }
            else if (mode == "READ_WRITE_SHARED" || mode == "s")
            {
                m = share(fullName(mv))
            }
            else
            {

```

```

per the rights          // Check the rights for the user and open the module as

                        if (canModify(i))
                        {
                            m = edit(fullName(mv))
                        }
                        else
                        {
                            m = read(fullName(mv))
                        }
                    }
                }
            if (null m)
            {
                // Something went wrong
                result = result "\nCould not open module " (fullName mv) "."
            }
            else
            {
                current = m
                Object o = gotoObject(objectAbsno, m, true)
                if (null o)
                {
                    result = result "\nCould not locate object " objectAbsno
                    "."
                }
                else
                {
                    result = result "\nObject " objectAbsno ""
                }
                if (!null o."Object Heading" && length(o."Object Heading" "")
                > 0)
                {
                    result = result "\nObject Heading: " o."Object Heading" ""
                }
            }

```

```

        if (!null o."Object Text" && length(o."Object Text" "") > 0)
        {
            result = result "\nObject Text: " o."Object Text" ""
        }
    }
}
}
}
return result
}

string obj_url = getURL(current Object)
print urlInfo(obj_url)

```

---

## getlegacyURL

---

### Declaration

```
string getLegacyURL(object o)
```

### Operation

This perm returns the legacy Rational DOORS URL. The legacy URL contains the protocol as "doors". This URL can then be decoded using `decodeURL`.

### Example

```

ModuleVersion mv
int objectAbsno
Item i
string dbHost = null
int dbPort
string dbName
string dbID = null

string objUrl = getURL(current Object)

string legacyUrl
string errorMsg
errorMsg = getLegacyURL(objUrl, legacyUrl)
if(!null errorMsg)
{
    print errorMsg "\n"
}

```

```

}
else
{
    errorMsg = decodeURL(legacyUrl, dbHost, dbPort, dbName, dbID, i, mv,
objectAbsno)
}
if(!null errorMsg)
{
    print errorMsg "\n"
}
else
{
    print "Original URL - " objUrl "\nDB Host - " dbHost "\n"
    print "DB Port - " dbPort "\nDB Name - " dbName "\nDB Id - " dbId
"\nAbsolute Number - " objectAbsno "\n"
}

```

---

## validateDOORSURL

---

### Declaration

```
string validateDOORSURL(string url)
```

### Operation

This perm takes a Rational DOORS URL and performs a basic check that the URL structure is correct and required elements are present.

The function returns NULL if the URL is successfully validated, or an error string if there is a problem.

### Example

```

Object o = current
string url = getURL o
string s = validateDOORSURL(url)

if (null s){
    print "URL is valid"
} else {
    print "Error in URL : " s
}

```

---

## isDefaultURL

---

### Declaration

```
bool isDefaultURL(string URL)
```

### Operation

Returns true if the supplied URL does not have an explicitly specified protocol.

### Example

```
string url = "www.google.com"
string fullURL

if (isDefaultURL(url)){
    fullURL = "http://" url
}
print fullURL
```

---

## getResourceURL

---

### Declaration

```
string getResourceURL(Module|Object|Database__|ModuleVersion|ModName__|Folder|Project|Item)
```

### Operation

Returns the resource URL of the passed in item.

---

## getResourceURLConfigOptions

---

### Declaration

```
void getResourceURLConfigOptions(string &dwaProtocol, string &dwaHost, int &dwaPort)
```

### Operation

Gets the *dwaProtocol*, *dwaHost*, and *dwaPort* DBAdmin options configured for this database. The *dwaProtocol*, *dwaHost*, and *dwaPort* parameters contain the values upon return.

---

## decodeResourceURL

---

### Declaration

```
string decodeResourceURL(string resourceURL, string &protocol, string& dbHost, int& dbPort, string& repositoryId,  
string& dbName, string& dbId, Item&, ModuleVersion&, string& viewName, int& objectAbsno)
```

### Operation

Breaks down a passed-in resource URL into its constituent parts and passes back the information as may be applicable into the reference parameters.

Returns `null` on success, error message on failure.





## Chapter 20

# Attributes

This chapter describes the use of Rational DOORS attributes from DXL:

- Attribute values
- Attribute value access controls
- Multi-value enumerated attributes
- Attribute definitions
- Attribute definition access controls
- Attribute types
- Attribute type access controls
- Attribute type manipulation
- DXL attribute

---

## Attribute values

This section defines constants, operators and functions for working with attribute values. Attribute values are one of the most important aspects of Rational DOORS.

Many example DXL programs in this manual or in the DXL library use attribute values.

---

### maximumAttributeLength

---

#### Declaration

```
int maximumAttributeLength
```

#### Operation

Defines a constant, which equates to the maximum number of characters in a string attribute.

---

### Attribute value extraction

---

Attribute names are available for use in combination with the `.` (dot) operator to extract the value of attributes. The syntax for using the attribute names is:

```
(Object o).(string attrName)
```

```
(Module m).(string attrName)
```

```
(Link l).(string attrName)
(ModuleProperties mp).(string attrName)
```

where:

*o* is an object of type Object  
*m* is a variable of type Module  
*l* is a variable of type Link  
*mp* is a variable of type ModuleProperties  
*attrName* is a string identifying the attribute

This means that you can write:

```
o."Object Heading"
m."Description"
l."Created By"
```

when you want to refer to the values of a named attribute of object *o*, module *m* or link *l*.

A selected attribute can be assigned the value of a DXL variable (see “Assignment (to attribute),” on page 429). Conversely, a DXL variable can be assigned the value of an attribute (see “Assignment (from attribute),” on page 428).

## Concatenation (attribute)

The space character is the concatenation operator, which is shown as `<space>` in the following syntax:

```
attrRef <space> string s
```

Concatenates string *s* onto *attrRef* and returns the result as a string.

Unlike assignment, the attribute can be of any type, because Rational DOORS automatically converts the value to a string.

### Example

```
string s = "Created On " (current
    Object)."Created On" "\n"
```

## Assignment (from attribute)

The assignment operator `=` can be used as shown in the following syntax:

```
bool b = attrRef
int i = attrRef
real r = attrRef
string s = attrRef
Date d = attrRef
```

where *attrRef* is in one of the following formats:

```
(Object o).(string attrName)
```

```
(Module m).(string attrName)
```

```
(Link l).(string attrName)
```

## Operation

These assign the value of the referenced attribute *attrRef* to bool *b*, int *i*, real *r*, string *s*, or Date *d*.

Boolean assignment is slightly unusual in that it enables the retrieval of the value of an enumeration attribute with two elements, such as an attribute of type `Boolean`. The first element in the enumeration maps to `false`; the second element maps to `true`.

All assignments return the result of the assignment.

## Example

```
Object o = current
Module m = current
Link l
int i    = o."Absolute Number"
real r
if (exists attribute "Cost")
    r = o."Cost"
else
    r = 0.0
string s = o."Created By"
Date    d = o."Created On"
bool    b = o."OLE"
print i " " r " " s " " d " " b "\n"
for l in o->"*" do {
    string s1 = l."Last Modified By"
    print s1 "\n"
}
string desc = m."Description"
print desc "\n"
int i2, i3
i3 = i2 = o."Absolute Number"
```

---

## Assignment (to attribute)

---

The assignment operator `=` can be used as shown in the following syntax:

```
attrRef = bool b
```

```

attrRef = int i
attrRef = real r
attrRef = string s
attrRef = Buffer b
attrRef = Date d

```

where *attrRef* is in one of the following formats:

```

(Object o).(string attrName)
(Module m).(string attrName)
(Link l).(string attrName)

```

## Operation

Assigns `bool b`, `int i`, `real r`, `string s`, `Buffer b`, or `Date d` to the attribute reference *attrRef*.

Again, boolean assignment enables the setting of an enumeration attribute that has two elements in its definition, such as an attribute of type `Boolean`.

## Example

```

Object o = current
o."Object Heading" = "Front Matter"
o."Integer Attribute" = 2
o."Accepted" = false

```

---

## canRead, canWrite(attribute)

---

### Declaration

```

bool canRead(Module m,
              string attrName)
bool canWrite(Module m,
              string attrName)
bool canRead(attrRef)
bool canWrite(attrRef)

```

where *attrRef* is in one of the following formats:

```

(Object o).(string attrName)
(Module m).(string attrName)
(Link l).(string attrName)

```

### Operation

The first two forms return whether the current Rational DOORS user can read or write values of the attribute name *attrName* in module *m*.

The third and fourth forms allow you to use the dot notation directly.

### Example

```
// Test current user permission
Module m
const string ACreatedBy = "Created By"
if (!canWrite(m, ACreatedBy) &&
    canRead(m, ACreatedBy)) {
    print "I can only read.\n"
}
// Use dot notation
Object o = current
const string ACreatedBy = "Created By"
if (!canWrite o.ACreatedBy && canRead o.ACreatedBy) {
    print "I can read the attribute but I cannot
        write to it.\n"
}
```

---

## type(attribute)

---

### Declaration

```
string type(Module m,
            string attrName)
```

```
string type(attrRef)
```

where *attrRef* is in one of the following formats:

```
(Object o).(string attrName)
```

```
(Module m).(string attrName)
```

```
(Link l).(string attrName)
```

### Operation

The first form returns the name of the type of the attribute named *attrName* in module *m*.

The second form enables you to use the dot notation directly.

### Example

```
// Use dot notation
print (type (current Object)."Object Heading") "\n"
// Use module
print (type (current Module,"Object Heading")) "\n"
```

---

## for module attributes in module

---

### Syntax

```
for attribute in attributes(module) do {
  ...
}
```

where:

```
attribute      is a string variable
module        is a variable of type Module
```

### Operation

Assigns the string *attribute* to be each successive attribute that is defined for *module*.

### Example

```
string modAttrName
for modAttrName in attributes (current Module) do
  print modAttrName "\n"
```

---

## for object attributes in module

---

### Syntax

```
for objAttrName in module do {
  ...
}
```

where:

```
objAttrName    is a string variable
module        is a variable of type Module
```

### Operation

Assigns the string *objAttrName* to be each successive attribute that is defined for objects in *module*.

### Example

```
string objAttrName
for objAttrName in (current Module) do print objAttrName "\n"
```

---

## unicodeString

---

### Declaration

```
string unicodeString(attrRef)
```

where *attrRef* is in one of the following formats:

```
(Object o).(string attrName)
```

```
(Module m).(string attrName)
```

```
(Link l).(string attrName)
```

### Operation

Returns the value of the specified attribute as plain text. If the attribute contains rich text including characters in Symbol font, then these characters are converted to the Unicode equivalents.

### Example

```
Object o = current
string s = unicodeString (o."Object Text")
print s "\n"
```

---

## getBoundedUnicode

---

### Declaration

```
string getBoundedUnicode(attrRef, int maxSize)
```

where *attrRef* is in one of the following formats:

```
(Object o).(string attrName)
```

```
(Module m).(string attrName)
```

```
(Link l).(string attrName)
```

### Operation

Returns a plain text value derived as in `unicodeString(attrRef)`, but limited to a maximum number of characters as specified by the *maxSize* argument.

### Example

```
Object o = current
string s = getBoundedUnicode(o."Object Text", 11)
print s "\n"
```

---

## Attribute value access controls

This section describes functions that report on access rights for an attribute value.

---

### canCreate(attribute)

---

#### Declaration

```
bool canCreate(Module m,
               string attrName)
```

```
bool canCreate(attrRef)
```

where *attrRef* is in one of the following formats:

```
(Object o).(string attrName)
```

```
(Module m).(string attrName)
```

```
(Link l).(string attrName)
```

#### Operation

The first form returns `true` if the current Rational DOORS user can create values of the attribute that is named *attrName* in module *m*. Otherwise, returns `false`.

The second form enables you to use the dot notation directly.

---

### canControl(attribute)

---

#### Declaration

```
bool canControl(Module m,
                string attrName)
```

```
bool canControl(attrRef)
```

where *attrRef* is in one of the following formats:

```
(Object o).(string attrName)
```

```
(Module m).(string attrName)
```

```
(Link l).(string attrName)
```

#### Operation

The first form returns `true` if the current Rational DOORS user can change the access controls on the attribute that is named *attrName* in module *m*. Otherwise, returns `false`.

The second form enables you to use the dot notation directly.



---

## canModify(attribute)

---

### Declaration

```
bool canModify(Module m,
               string attrName)
```

```
bool canModify(attrRef)
```

where *attrRef* is in one of the following formats:

```
(Object o).(string attrName)
```

```
(Module m).(string attrName)
```

```
(Link l).(string attrName)
```

### Operation

The first form returns `true` if the current Rational DOORS user can modify values of the attribute that is named *attrName* in module *m*. Otherwise, returns `false`.

The second form enables you to use the dot notation directly.

---

## canDelete(attribute)

---

### Declaration

```
bool canDelete(Module m,
               string attrName)
```

```
bool canDelete(attrRef)
```

where *attrRef* is in one of the following formats:

```
(Object o).(string attrName)
```

```
(Module m).(string attrName)
```

```
(Link l).(string attrName)
```

### Operation

The first form returns `true` if the current Rational DOORS user can delete values of the attribute that is named *attrName* in module *m*. Otherwise, returns `false`.

The second form enables you to use the dot notation directly.

---

## Multi-value enumerated attributes

This section defines functions that apply to multi-value enumerated attributes.

---

## Assignment (enumerated option)

---

The assignment operators `+=` and `-=` can be used as shown in the following syntax:

```
attrRef += string s
attrRef -= string s
```

where `attrRef` is in one of the following formats:

```
(Object o).(string attrName)
(Module m).(string attrName)
(Link l).(string attrName)
```

### Operation

Adds or removes an enumerated option from the value of the attribute.

### Example

This example adds "Australia" to the list of values of the attribute "Country" of the current object, and removes "Borneo".

```
Object o = current
o."Country" += "Australia"
o."Country" -= "Borneo"
```

---

## isMember

---

### Declaration

```
bool isMember(attrRef,
              string s)
```

where `attrRef` is in one of the following formats:

```
(Object o).(string attrName)
(Module m).(string attrName)
(Link l).(string attrName)
```

### Operation

Returns `true` if the option specified as `s` is present in the multi-value attribute.

### Example

```
if (isMember((current Object)."Country", "Australia")) {
    addRequirement("Right-hand drive model
                  needed")
}
```

---

## Attribute definitions

This section defines functions and a `for` loop that manipulate Rational DOORS attribute definitions. The fundamental type that is used is `AttrDef`, which is a handle on an attribute definition.

**Note:** Reloading a module (for example, changing edit modes) in a DXL script removes any attribute definition values currently assigned to variables in that script. If a module is reloaded, reassign the attribute definitions.

---

## Attribute definition properties

Properties are defined for use with the `.` (dot) operator and an attribute definition handle to extract information from an attribute definition, as shown in the following syntax:

```
(AttrDef ad).property
```

The following tables list the properties and the information they extract:

String property	Extracts
<code>dxl</code>	DXL text of an attribute that uses DXL attribute.
<code>name</code>	The name of an attribute definition.
<code>typeName</code>	The name of the type of an attribute definition.
<code>description</code>	The description of the attribute definition.
<code>uri</code>	The URI of an attribute definition.

Boolean property	Extracts
<code>canWrite</code>	Whether the user can delete the attribute definition.
<code>defval</code>	Whether the attribute definition is for an attribute that has a default value.
<code>dxl</code>	Whether the attribute definition is for an attribute that has its value generated by DXL.
<code>hidden</code>	Whether the attribute definition is for an attribute that is hidden. This function is provided only for forward compatibility with future releases of Rational DOORS.
<code>inherit</code>	Whether the attribute definition is for an attribute that is inherited.
<code>module</code>	Whether the attribute definition is defined for the module.

---

Boolean property	Extracts
<code>multi</code>	Whether the attribute definition is of the multi-value enumeration type.
<code>nobars</code>	Whether the attribute definition is for an attribute that does not alter change bars.
<code>nochanges</code>	Whether the attribute definition is for an attribute that does not change modification status attributes.
<code>nohistory</code>	Whether the attribute definition is for an attribute that does not generate history.
<code>object</code>	Whether the attribute definition is defined for objects.
<code>system</code>	Whether the attribute is system defined.
<code>useraccess</code>	Whether users can update the value of the attribute. For example, for a system attribute such as "Last Modified On" it returns <code>false</code> , because users can never update it, regardless of access controls. For an attribute such as "Object Heading" it returns <code>true</code> , because users can update its value provided they have appropriate access controls.

Any type property	Extracts
<code>type</code>	An <code>AttrType</code> for the attribute type of the attribute definition.

Default property	Extracts
<code>defval</code>	The default value for the attribute definition; for correct operation, always assign the result to a variable of the correct type for the attribute.

## Example

This example uses string properties:

```
// name
AttrDef ad = find(current Module, "Object Text")
print ad.name           // prints Object Text
// typeName
AttrDef ad = find(current Module, "Created On")
print ad.typeName      // prints Date
```

```
// dxl
AttrDef ad = find(current Module, "DXL initialized attribute")
if (ad.dxl) {
    string dxlVal = ad.dxl
    print dxlVal "\n"
}
// useraccess
AttrDef ad
Module m = current
for ad in m do {
    print ad.name "-" ad.useraccess "\n"
}
```

This example uses boolean properties:

```
// object
AttrDef ad = find(current Module, "Description")
print ad.object          // prints false
// module
AttrDef ad = find(current Module, "Description")
print ad.module         // prints true
// system
if (thisAttr.system) {
    ack "System attribute: cannot delete"
}
// canWrite
AttrDef ad
Module m = current
for ad in m do{
    print ad.name "-" ad.canWrite "\n"
}
```

This example uses the property type:

```
AttrDef ad = find(current Module, "Description")
AttrType at = ad.type
print at.name          // prints String
```

This example uses the property defval for a default value of type string:

```
AttrDef ad = find(current Module, "Created Thru")
string def = ad.defval
print def              // prints Manual Input
```

---

## Concatenation (attribute definition)

---

The space character is the concatenation operator. All the individual elements of an attribute definition can be concatenated.

---

## create(attribute definition)

---

### Syntax

```
AttrDef create([module|object]
               [property value]...
               [(default defVal)]
               attribute(string attrName))
```

### Operation

Creates a new attribute definition called *attrName* from the call to *attribute*, which is the only argument that must be passed to *create*. The optional arguments modify *create*, by specifying the value of attribute properties. The arguments can be concatenated together to form valid attribute creation statements.

The keywords *module* and *object* specify that the attribute definition that is being created applies to modules or objects, respectively.

The default property specifies the default value for the attribute definition that is being created as *defVal*. This property should always be specified within parenthesis to avoid parsing problems. The value must be given as a string, even if the underlying type is different. Rational DOORS converts the value automatically.

As required, you can specify other properties. The defaults are the same as the Rational DOORS user interface.

String property	Specifies
<i>dxl</i>	The code that is associated with an attribute in <i>dxl code</i> .
<i>type</i>	The type of the attribute definition as <i>typeName</i> .
<i>description</i>	The description of the attribute definition.
<i>uri</i>	The URI of an attribute definition.

Boolean property	Specifies
<i>changeBars</i>	Whether the attribute definition that is being created alters change bars.
<i>date</i>	Whether the attribute definition that is being created alters dates.
<i>hidden</i>	Whether the attribute definition that is being created is hidden.
	Note that this function is only provided for forward compatibility with future releases of Rational DOORS.

---

Boolean property	Specifies
<code>history</code>	Whether the attribute definition that is being created generates history.
<code>inherit</code>	Whether the attribute definition that is being created is to be inherited.
<code>multi</code>	A multi-valued attribute definition, if expression evaluates to <code>true</code> ; otherwise a single-valued attribute definition.

## Example

- This example builds an attribute named "Count" which has a default value of 0:  

```
create (default "0") attribute "Count"
```
- This example builds an integer attribute named "Cost" which applies to the module:  

```
create module type "Integer" attribute "Total Cost"
```
- This example builds an integer attribute named "Cost" which applies to the objects in the module, but not the module itself:  

```
create object type "Integer" attribute "Cost"
```
- This example uses some of the other attribute definition functions:  

```
create module type "String" (default "Help") history true //-
    changeBars false date false inherit true           //-
    hidden false attribute "Usage"
```
- This example creates an "Integer" attribute definition called "Cost2", which applies only to objects:  

```
create attribute "Cost2"
```
- This example creates a multi-valued attribute definition "attribute name", which uses the enumeration type "enumeration name" and sets its default to two values: value1 and value2.  

```
create type "enumeration name" (default "value1\nvalue2") //-
    multi true attribute "attribute name"
```

A newline character must be used to separate the different values.
- This example defines code associated with attribute called "cost":  

```
AttrDef ad = create object type "Integer" attribute "cost" //-
    dxl "int i = 10 \n obj.attrDXLName = i "
```

---

## delete(attribute definition)

---

### Declaration

```
string delete([Module m,]
              AttrDef ad)
```

### Operation

Deletes the attribute definition *ad* from module *m*. If *m* is omitted, deletes *ad* from the current module.

## Example

```
void deleteAttrDef(string s)
{
    string err
    AttrDef ad = find(current Module, s)
    err = delete(ad)
    if (err != "") ack err
}
deleteAttrDef "attribute_name"
```

---

## exists

---

### Declaration

```
bool exists(attribute(string attributeName))
```

### Operation

Returns true if the attribute named *attributeName* exists in the current module.

### Example

```
if (exists attribute "Cost")
    print "Cost is already there.\n"
```

---

## find(attribute definition)

---

### Declaration

```
AttrDef find(Module m,
              string attributeName)
```

### Operation

Returns the attribute definition for the attribute named *attributeName* in module *m*.

### Example

```
AttrDef ad = find(current Module, "Object Heading")
```

---

## attributeValue

---

### Declaration

```
bool attributeValue(AttrDef attrDef,
                   string s)
```



## Operation

Returns `true` if the specified string contains valid data for the specified attribute definition. Returns `false` if the specified string contains invalid data for the specified attribute.

## isAttributeValueInRange

### Declaration

```
bool isAttributeValueInRange (AttrDef ad, attrRef)
```

where `attrRef` can be one of:

```
(Object o).(string attrName)
```

```
(Module m).(string attrName)
```

```
(Link l).(string attrName)
```

### Operation

If the value of the attribute `attrRef` is within the range defined for Attribute Definition `ad`, then return `true`. Otherwise, return `false`.

**Note:** For attributes based on types that are *not* ranged, always returns `true`.

## getBoundedAttr

### Declaration

```
string getBoundedAttr (attrRef attrdef,  
                      int number)
```

where `attrRef` is in one of the following formats:

```
(Object o).(string attrName)
```

```
(Module m).(string attrName)
```

```
(Link l).(string attrName)
```

### Operation

Returns the first `number` of characters of the value of attribute definition `attrDef`.

This is particularly useful when working with attribute values that could potentially be extremely large (for example, encoded picture data) but the entire value is not required.

### Example

```
Object o = current  
print getBoundedAttr(o."Object Text", 3)
```

---

## hasSpecificValue

---

### Declaration

```
bool hasSpecificValue({Link l|Module m|Object o},
                    AttrDef attrDef)
```

### Operation

Returns `true` if the attribute definition `attrDef` has a specific value for link `l`, open module `m`, or object `o`. Otherwise, returns `false`.

---

## isVisibleAttribute

---

### Declaration

```
bool isVisibleAttribute(AttrDef attrDef)
```

### Operation

Returns `true` if the specified attribute is not a hidden attribute. Returns `false` if the specified attribute is a hidden attribute.

**Note:** This only applies to object attributes. It return `false` when used with module attributes.

---

## modify(attribute definition)

---

### Declaration

```
AttrDef modify(AttrDef old,
               [setProperty value,]
               AttrDef new)
```

### Operation

Modifies an existing attribute definition by passing it a new attribute definition. The optional second argument enables you to set a single property, as follows:

String property	Sets
<code>setDefault</code>	The default string.
<code>setDXL</code>	The attribute to DXL code contained in the string argument.
<code>setName</code>	The attribute's name in a string.
<code>setDescription</code>	The attribute description.
<code>uri</code>	The URI of an attribute definition.

---

Boolean property	Sets
<code>setBars</code>	Whether the attribute alters change bars.
<code>setDates</code>	Whether the attribute alters dates.
<code>setHidden</code>	Whether the attribute is hidden.
<code>setHistory</code>	Whether the attribute generates history.
<code>setInherit</code>	Whether the attribute is inherited.
<code>setModule</code>	Whether the attribute definition is for modules.
<code>setMulti</code>	Whether the attribute definition is a multi-valued enumeration type.
<code>setObject</code>	Whether the attribute definition is for objects.

Locale property	Sets
<code>setLocale</code>	The attribute's locale.

### Example 1

```
AttrDef ad = create object type "Integer" attribute "cost"
ad = modify(ad, object type "Integer" attribute "Costing")
ad = modify(ad, setHistory, true)
ad = modify(ad, setDefault, "123")
ad = modify(ad, setURI, "http://www.webaddress.com")
```

### Example 2

This example uses Locale properties

```
Locale loc = userLocale
AttrDef ad = find(current Module, "Object Text")
Modify (ad, setLocale, loc)
```

---

## for attribute definition in module

---

### Syntax

```
for ad in {module|modProps} do {
  ...
}
```

where:

*ad* is a variable of type `AttrDef`  
*module* is a variable of type `Module`  
*modProps* is a variable of type `ModuleProperties`

## Operation

Assigns the attribute definition *ad* to be each successive definition present in the module *module*, or *modProps*, provided the definition applies to either modules or objects.

## Example

```
AttrDef ad
for ad in current Module do {
    print "Attribute: " ad.name "\n"
}
```

---

## for module level attribute definition in {Module|ModuleProperties}

---

## Syntax

```
for ad in attributes {mod|modprops} do {
    ...
}
```

where:

---

<i>ad</i>	is a variable of type <code>AttrDef</code>
<i>mod</i>	is a variable of type <code>Module</code>
<i>modprops</i>	is a variable of type <code>ModuleProperties</code>

---

## Operation

Assigns *ad* to be the name of each successive module level attribute definition in the supplied `Module`, or `ModuleProperties`.

---

## Attribute definition example program

---

```
// attribute definition DXL example
```

```

/*
  Example of Attribute Definition DXL
*/
void print(AttrDef ad) { // print out some information on ad
    print ad.name ": "
    print "type \"" ad.typeName "\""
    // does ad apply to objects?
    print (ad.object ? " object " : "")
    // does ad apply to modules?
    print (ad.module ? " module" : "")
    print (ad.inherit ? " inherit" : "")
    // are values inherited?
    AttrType typ = ad.type
    if (typ.name == "Integer" && ad.defval) {
        // print any default int value
        int d = ad.defval
        print " default " d ""
    }
    if (ad.dxl) {
        string dxlVal = ad.dxl
        print " isDxl \"" dxlVal "\""
        // does ad use DXL attribute?
    }
    print "\n"
} // print
// main program
// create two new attributes
create object type "Integer" attribute "Cost"
create module type "Integer" attribute "Total Cost"
AttrDef ad
// print module attribute definitions
print "Module attribute definitions:\n\n"
for ad in current Module do
    if (ad.module)
        print ad
// print object attribute definitions
print "Object attribute definitions:\n\n"

```

```
for ad in current Module do
  if (ad.object)
    print ad
```

For a larger example of the use of `AttrType`, `AttrDef` and Rational DOORS attributes, see `$DOORSHOME/lib/dxl/utils/copyops.inc`, which enables the copying of an attribute of an object in one module to an object in another module. If the target module does not have the necessary attribute types and definitions, they are automatically constructed.

---

## Attribute definition access controls

This section describes functions that report on access rights for an attribute definition.

---

### canCreateDef

---

#### Declaration

```
bool canCreateDef(AttrDef attrDef)
```

#### Operation

Returns `true` if the current Rational DOORS user has create access to the attribute definition `attrDef`.

---

### canCreateVal

---

#### Declaration

```
bool canCreateVal(AttrDef attrDef)
```

#### Operation

Returns `true` if the current Rational DOORS user has create access to the value of the attribute definition `attrDef`.

---

### canControlDef

---

#### Declaration

```
bool canControlDef(AttrDef attrDef)
```

#### Operation

Returns `true` if the current Rational DOORS user can change the access controls on the attribute definition `attrDef`.

---

## canControlVal

---

### Declaration

```
bool canControlVal (AttrDef attrDef)
```

### Operation

Returns `true` if the current Rational DOORS user can change the access controls on the value of the attribute definition *attrDef*.

---

## canDeleteDef

---

### Declaration

```
bool canDeleteDef (AttrDef attrDef)
```

### Operation

Returns `true` if the current Rational DOORS user can delete the attribute definition *attrDef*. Otherwise, returns `false`.

---

## canDeleteVal

---

### Declaration

```
bool canDeleteVal (AttrDef attrDef)
```

### Operation

Returns `true` if the current Rational DOORS user can delete the value of the attribute definition *attrDef*. Otherwise, returns `false`.

---

## canCreateAttrDefs

---

### Declaration

```
bool canCreateAttrDefs (Module m)
```

### Operation

Returns `true` if the current Rational DOORS user has create access for attribute definition in Module *m*.

## Attribute types

This section defines the functions that manipulate the types of Rational DOORS attributes. The following types are used: `AttrType`, which is a handle on an attribute type; and `AttrBaseType`, which is a handle on an attribute type's base type.

`AttrBaseType` can have the following values:

Scalar	Ranged	<code>attrDate</code>
	Ranged	<code>attrInteger</code>
	Ranged	<code>attrReal</code>
	Simple	<code>attrText</code>
	Simple	<code>attrString</code>
	Simple	<code>attrUsername</code>
Aggregate	Enumeration	<code>attrEnumeration</code>

They are used for determining the base type of an attribute type, for example, you might have an attribute type called "1 to 10" whose base type is an integer but has limits of 1 and 10.

Ranged types can have a maximum and minimum value.

## Attribute type properties

Properties are defined for use with the `.` (dot) operator and an attribute type handle to extract information from an attribute type, as shown in the following syntax:

```
(AttrType at).property
```

The following tables list the properties and the information they extract:

String property	Extracts
<code>name</code>	The name of an attribute type.
<code>strings[n]</code>	provides access to the names of an enumerated attribute type; the <i>n</i> th element (counting from 0). In the Rational DOORS user interface, this is the 'value' of the enumerated type.
<code>description</code>	The description of the attribute type
<code>description[s]</code>	The descriptions of the values in an enumerated type.



<b>Boolean property</b>	<b>Extracts</b>
<code>canWrite</code>	Whether the user can delete the attribute type.
<code>system</code>	Whether the attribute type is system defined.

<b>Integer property</b>	<b>Extracts</b>
<code>colors[n]</code> <code>colours[n]</code>	The <i>n</i> th element (counting from 0) of the array of colors that are used in an enumeration attribute type.
<code>maxValue</code>	The maximum value for an attribute type or tests for the presence of a maximum value. Can also be of type <code>Real</code> or <code>Date</code> .
<code>minValue</code>	The minimum value for an attribute type or tests for the presence of a minimum value. Can also be of type <code>Real</code> or <code>Date</code> .
<code>size</code>	The number of elements of an enumerated type.
<code>values[n]</code>	The <i>n</i> th element (counting from 0) of the array of values used in an enumeration attribute type. In the Rational DOORS user interface, this is the 'related number' of the enumerated type.

<b>Any type property</b>	<b>Extracts</b>
<code>type</code>	The base type of an attribute type.

## Example

```
// name
AttrType at = find(current Module, "Created Thru")
print at.name           // prints "Created Thru"
// type
AttrType at = find(current Module, "Integer")
print stringOf at.type
print at.type "\n"
// test for a minimum value
AttrType at = find(current Module, "Type with Min Int value")
```

```

if (at.minValue) {
    // Enter here if type has a minimum value.
    // The following is valid only if base type
    // is integer.
    // The operator is also defined for real and
    // date
    int i = at.minValue
}
// strings
AttrType t
t=find(current Module, "TableType")
print t.strings[1]
// size
AttrType at = find(current Module, "Boolean")
print at.size           // prints "2"
// names
AttrType at = find(current Module, "Boolean")
print at.strings[0]
print at.strings[1]
// values
AttrType at = find(current,"Boolean")
print at.values[0]
print at.values[1]
// colors
AttrType at = find(current,"Boolean")
print at.colours[0]
print at.colors[1]
// canWrite and system
AttrType at
Module m = current
for at in m do{
    print at.name "- system: " at.system"; can
        write: " at.canWrite "\n"
}

```

---

## Concatenation (attribute base type)

---

The space character is the concatenation operator, which is shown as `<space>` in the following syntax:

```
AttrBaseType abt <space> string s
```

Concatenates the string *s* onto the attribute base type *abt* and returns the result as a string.

---

## find(attribute type)

---

### Declaration

```
AttrType find(Module m,
               string typeName)
```

### Operation

Returns an attribute type handle for the attribute type named *typeName* in the module *m*, or null if the type does not exist.

### Example

```
AttrType at = find(current Module, "Boolean")
if (null at)
    print "Failed\n"
```

---

## isRanged

---

### Declaration

```
bool isRanged(AttrType attrType)
```

### Operation

Returns `true` if *attrType* is a range (can take minimum and maximum values). Otherwise, returns `false`.

---

## isUsed

---

### Declaration

```
bool isUsed(AttrType attrType)
```

### Operation

Returns `true` if *attrType* is in use, in which case, its base type cannot be changed. Otherwise, returns `false`. For information on changing an attribute type's base type, see the `modify(attribute type)` function.

---

## print(attribute base type)

---

### Declaration

```
void print(AttrBaseType abt)
```

### Operation

Prints the attribute base type *abt* in the DXL Interaction window's output pane.

---

## stringOf(attribute base type)

---

### Declaration

```
string stringOf(AttrBaseType abt)
```

### Operation

Returns attribute base type *abt* as a string.

---

## getRealColorOptionForTypes

---

### Declaration

```
bool getRealColorOptionForTypes()
```

### Operation

Returns `true` if the values contained within the color array of an `AttrType` are real color identifiers. Returns `false` if the values are logical color identifiers (the default).

---

## setRealColorOptionForTypes

---

### Declaration

```
void setRealColorOptionForTypes(bool  
    realColors)
```

### Operation

If *realColors* is `true`, sets the values contained within the color array of an `AttrType` to real color identifiers. If *realColors* is `false`, sets the values to logical color identifiers (the default).

**Note:** The functions that create and modify an `AttrType` expect arrays of real colors as arguments. Therefore, prior to any calls being made to either `create(attribute type)` or `modify(attribute type)`, this function must be called setting *realColors* to `true`.

---

## setDescription

---

### Declaration

```
AttrType setDescription(AttrType at, string desc, string &errMess)
```

### Operation

Sets the description for the specified attribute type. Returns null if the description is not successfully updated.

---

## setURI

---

### Declaration

```
AttrType setURI(AttrType at, string URI, string &errMess)
```

```
AttrType setURI(AttrType at, string name, string URI, string &errMess)
```

```
AttrType setURI(AttrType at, int index, string URI, string &errMess)
```

### Operation

Sets the URI for the specified attribute type. Returns a modified attribute type. If there is an error, the message is returned in the final string parameter. The URI can be set for a specified enumeration value or enumeration index.

### Example

```
AttrType at
string errorMsg
string index[] = { "first", "second", "third" }
at = setURI(at, "http://www.webaddress.com", errorMsg)
at = setURI(at, index[0], "http://www.webaddress.com", errorMsg)
```

---

## getURI

---

### Declaration

```
string uri(AttrType at)
```

```
string uri(AttrType at, string name)
```

```
string uri(AttrType at, int index)
```

### Operation

Gets the URI for the specified attribute type or for a named enumeration value or for an enumeration index.

---

## for attribute type in module

---

### Syntax

```
for at in Module m do {
  ...
}
```

where:

*at* is a variable of type `AttrType`  
*m* is a variable of type `Module`

### Operation

Assigns the variable *at* to be each successive attribute type definition found in module *m*.

### Example

```
AttrType at
for at in current Module do {
  print at.name "\n"
}
```

---

## Attribute type access controls

This section describes functions that report on access rights for an attribute type.

---

### canCreate(attribute type)

---

#### Declaration

```
bool canCreate(AttrType attrType)
```

#### Operation

Returns `true` if the current Rational DOORS user has create access to the attribute type *attrType*.

---

### canControl(attribute type)

---

#### Declaration

```
bool canControl(AttrType attrType)
```

## Operation

Returns `true` if the current Rational DOORS user can change the access controls on the attribute type *attrType*.

### canModify(attribute type)

#### Declaration

```
bool canModify(AttrType attrType)
```

#### Operation

Returns `true` if the current Rational DOORS user can modify the attribute type *attrType*.

### canRead(attribute type)

#### Declaration

```
bool canRead(AttrType attrType)
```

#### Operation

Returns `true` if the current Rational DOORS user can read the attribute type *attrType*.

### canDelete(attribute type)

#### Declaration

```
bool canDelete(AttrType attrType)
```

#### Operation

Returns `true` if the current Rational DOORS user can delete the attribute type *attrType*. Otherwise, returns `false`.

### canCreateAttrTypes

#### Declaration

```
bool canCreateAttrTypes(Module m)
```

#### Operation

Returns `true` if the current Rational DOORS user has create access for attribute types in Module *m*.

## Attribute type manipulation

This section defines functions for creating new attribute types, modifying, and deleting them.

To modify an attribute type, the user must have modify access to it (the `canWrite` property returns `true`). No changes can be made in edit shareable mode or read-only mode. System types cannot be edited (the `system` property returns `true`). For information on properties, see “Attribute type properties,” on page 450.

---

## create(attribute type)

---

### Declaration

```
AttrType create(string name,
                AttrBaseType abt,
                string &errmsg)
```

```
AttrType create(string name,
                {int|real|Date} min,
                {int|real|Date} max,
                string &errmsg)
```

```
AttrType create(string name,
                string codes[ ],
                [int values[ ],
                [int colors[ ],]
                [string descsc[ ],]
                [string URI[ ],]
                string &errmsg)
```

### Operation

If the operation fails, all forms of `create` return an error message in `errmsg`.

The function also throws a run-time DXL error for an invalid input, for example a duplicate type name. These errors can be trapped using `lastError` and `noError`.

The first form creates a new attribute type, of name `name` and base type `abt`.

The next form creates a new attribute type named `name`, of base type `int`, `real` or `Date`, for a range of `min` to `max`.

The last form creates enumeration types named `name`, using enumeration names `codes`, with optional values `values`, colors `colors`, descriptions `descsc`, and URI `URI`. The argument `URI [ ]` is the URI for each value.

**Note:** This function expects arrays of real colors as arguments. Therefore, prior to any calls being made to `create`, the `setRealColorOptionForTypes` function must be called setting `realColors` to `true`.

### Example

```
// basic create
string errmsg = ""
AttrType at = create("Cost", attrInteger, errmsg)
if (!null errmsg)
    print "Attribute type creation failed\n"
```



```
// create enumeration type
string names[] = {"Tested", "Under Test", "Not Tested"}
int values[] = {1,2,3}
int colors[] = {-1, 20, 14}
string mess = ""
AttrType at = create("Test Status", names, values, colors, mess)
if (!null mess)
    print "Type creation failed\n"
```

---

## delete(attribute type)

---

### Declaration

```
bool delete(AttrType at,
            string &errmsg)
```

### Operation

Deletes the `AttrType` whose handle is `at`. If the operation fails, returns an error message in `errmsg`.

---

## modify(attribute type)

---

### Declaration

```
AttrType modify(AttrType type,
                string newName
                [, string codes[ ],
                int values[ ],
                int colors[ ],
                string desc[ ],
                string URI[ ],
                [, int arrMaps[ ],])
                string &errmsg)
```

```
AttrType modify(AttrType type,
                AttrBaseType new,
                string &errmsg)
```

### Operation

The first form, without any optional parameters, changes the name of the specified attribute type to `newName`. If supplied, `codes`, `values`, `colors`, `descs`, and `URI` modify those properties of an existing enumerated type. The argument `URI[ ]` is the URI for each enumerated type. In the user interface, the term **values** maps to `codes`, and the term **related numbers** maps to `values`. If the `type` is being used by an attribute, colors cannot be added where they were not previously assigned, and, `arrMaps` must be supplied in order to map old values to the new ones.

The second form changes the base type of the specified attribute type. If *type* is in use the call fails.

**Note:** Color numbers now refer to real colors rather than logical colors. Enumerated attribute types in Rational DOORS 4 have their colors translated during migration.

For all forms, the *errmsg* argument is currently not used, but is reserved for future enhancements. You can trap errors using *lastError* and *noError*.

**Note:** This function expects arrays of real colors as arguments. Therefore, prior to any calls being made to modify, the *setRealColorOptionForTypes* function must be called setting *realColors* to true.

## Example

//This example adds "Invalid Test" to the end of the list of possible enumeration values, leaving the remaining value intact.

```
AttrType modifyAndAdd(AttrType atTypeToEdit, string sTypeName, string
arrValues[], int arrOrdinals[], int arrColours[], string& sErrMsg)
```

```
{
    int arrMaps[atTypeToEdit.size + 1]
    int i

    for (i = 0; i < atTypeToEdit.size + 1; i++) {
        arrMaps[i] = i;
    }

    return modify(atTypeToEdit, sTypeName, arrValues, arrOrdinals, arrColours,
arrMaps, sErrMsg)
}
```

```
setRealColorOptionForTypes(true)
AttrType at = find(current Module, "Test Status")

string new_strings[at.size+1]
int new_values[at.size+1]
int new_colors[at.size+1]

int i=0
for(i = 0; i < at.size; i++)
{
    new_strings[i] = at.strings[i]
```

```

        new_values[i] = at.values[i]
        new_colors[i] = at.colors[i]
    }

string errmsg
new_strings[at.size] = "highest" // This is name of new value for type
new_values[at.size] = at.size
new_colors[at.size] = -1

string at_name = at.name
AttrType at_new = modifyAndAdd(at, at_name, new_strings, new_values, new_colors,
errmsg)
AttrType modifyAndAdd(AttrType atTypeToEdit, string sTypeName, string
arrValues[], int arrOrdinals[], int arrColours[], string& sErrMsg)
{
    int arrMaps[atTypeToEdit.size + 1]
    int i

    for (i = 0; i < atTypeToEdit.size + 1; i++) {
        arrMaps[i] = i;
    }

    return modify(atTypeToEdit, sTypeName, arrValues, arrOrdinals, arrColours,
arrMaps, sErrMsg)
}

setRealColorOptionForTypes(true)
AttrType at = find(current Module, "Test Status")

string new_strings[at.size+1]
int new_values[at.size+1]
int new_colors[at.size+1]

int i=0
for(i = 0; i < at.size; i++)

```

```

{
    new_strings[i] = at.strings[i]
    new_values[i] = at.values[i]
    new_colors[i] = at.colors[i]
}

string errmsg
new_strings[at.size] = "Invalid Test"      // This is name of new value for type
new_values[at.size] = at.size
new_colors[at.size] = -1

string at_name = at.name
AttrType at_new = modifyAndAdd(at, at_name, new_strings, new_values, new_colors,
errmsg)

```

---

## setMaxValue

---

### Declaration

```

bool setMaxValue(AttrType type,
                 {int|real|Date} maxValue,
                 bool maxApplies)

```

### Operation

Specifies a maximum value for the ranged attribute type *type*, provided *maxApplies* is true.

If the call succeeds, returns true; otherwise, returns false. If *maxApplies* is false, the maximum value is ignored, and the function returns true.

If the specified maximum value is less than the minimum value, the call fails.

If the specified type is not a ranged type, or is not of the same type as *maxValue*, a run-time error occurs, which can be trapped using `lastError` and `noError`.

### Example

```

Module m = current
AttrType atype = find(m, "MyType")
string sBaseType = stringOf(atype.type)
if(sBaseType == "Integer")
{
    // set a maximum of 100, and enable the
    // maximum

```

```

        setMaxValue (atype, 100, true)
    }

```

---

## setMinValue

---

### Declaration

```

bool setMinValue (AttrType type,
                 {int|real|Date} minValue,
                 bool minApplies)

```

### Operation

Specifies a minimum value for the ranged attribute type *type*, provided *minApplies* is *true*.

If the call succeeds, returns *true*; otherwise, returns *false*. If *minApplies* is *false*, the maximum value is ignored, and the function returns *true*.

If the specified maximum value is less than the minimum value, the call fails.

If the specified type is not a ranged type, or is not of the same type as *minValue*, a run-time error occurs, which can be trapped using *lastError* and *noError*.

### Example

```

Module m = current
AttrType atype = find(m, "MyType")
string sBaseType = stringOf (atype.type)
if (sBaseType == "Integer")
{
    //set a minimum of 10, and enable the minimum
    setMinValue (atype, 10, true)
}

```

---

## DXL attribute

DXL attribute is an option on the Define Attribute window, which enables you to write a DXL program that calculates the value of the attribute being defined. The calculation only takes place the first time the attribute is accessed, or if it is later cleared to null and is subsequently accessed again. This means the DXL code is not executed when the containing module is opened, but when some event occurs that causes the attribute to be accessed. For example, the event could be because the attribute is being displayed in a column, or because the user opens the Formal Object Editor window on an object with a DXL attribute value.

DXL attribute provides a means of initializing an attribute using DXL, and then caching that value so that subsequent attribute access does not involve recalculation. If the code resets the attribute to the null string, recalculation occurs on the next access. Just setting the value to the null string is not sufficient to invoke recalculation. The attribute value must be accessed after the reset to null, for a recalculation to take place.

For example, if attribute "Outgoing" is displayed in a Rational DOORS column, the initial value is calculated for each "Outgoing" attribute as the user views it. If more outgoing links are created, the attribute values do not change; to do this, the recalculation must be forced, possibly from another DXL application that contains the following script fragment:

```
Object o
for o in current Module do
    o."Outgoing" = (string null)
```

The `(string null)` ensures a null value, as compared to the integer 0, or the empty string "".

**Note:** The perm `void refresh (Module m)` should not be used in DXL attributes.

## attrDXLName

### Declaration

```
Object obj
const string attrDXLName
```

### Operation

DXL attribute programs run in a context where the variable `obj` is already declared to refer to the object whose attribute is being calculated.

The constant `attrDXLName` can be used instead of a literal attribute name to refer to the attribute value that is being calculated. This enables one piece of DXL attribute to be used for several attributes without being modified.

### Example

```
obj.attrDXLName = today
```

## DXL attribute example program

This example in `$DOORSHOME/lib/dxl/attrib/impact.dxl`:

```
// impact.dxl -- example of DXL attribute
/*
    DXL attribute provides a means of initializing
    an attribute using DXL, so that subsequent
    accesses of the attribute do not involve
    re-calculation.
    This example of DXL attribute requires that an
    integer attribute named "Outgoing" exists and
    has been defined with the Rational DOORS GUI to use this
    file as its DXL value.
    "Outgoing" is set to the number of links
    leaving its object.
*/
Link l
```

```
int count = 0
// obj is the predeclared object whose attribute
// we are calculating
for l in obj->"*" do count++
// count outgoing links
obj."Outgoing" = count
// initialize the cached value
// resetting to (string null)
// in a DXL program
// will force re-calculation
// end of impact.dxl
```





## Chapter 21

# Access controls

This chapter describes access controls:

- Controlling access
- Locking
- Example programs

---

## Controlling access

This section defines properties, operators, functions and `for` loops that work with access controls. Many of these elements use the data types `Permission` and `AccessRec`.

---

### Properties

The following properties of type `Permission` are used for setting access controls, using the assignment operator.

<code>none</code>	
<code>read</code>	This is automatically given for <code>modify</code> , <code>create</code> , <code>delete</code> , or <code>control</code> .
<code>create</code>	Automatically confers <code>read</code> access. Automatically given for <code>control</code> .
<code>modify</code>	Automatically confers <code>read</code> access. Automatically given for <code>control</code> .
<code>delete</code>	Automatically confers <code>read</code> and <code>modify</code> access.
<code>control</code>	Automatically confers <code>read</code> , <code>modify</code> and <code>create</code> access.
<code>write</code>	This is a bitwise OR of <code>modify</code> , <code>create</code> and <code>delete</code> ; it is only supported for compatibility with earlier releases.
<code>change</code>	Identical to <code>control</code> , this is only supported for compatibility with earlier releases.

---

### Operators

As with other data types, the assignment operator `=` is used to set a permission, as shown in the following syntax:

```
Permission p = permission
```

where:

*p* is a variable of type `Permission`

*permission* is a variable of type `Permission`

The `|` (pipe) operator performs bitwise OR operations on permissions as shown in the following syntax:

```
Permission x | Permission y
```

The `&` operator performs bitwise AND operations on permissions as shown in the following syntax:

```
Permission x & Permission y
```

The `==` relational operator performs comparison on permissions as shown in the following syntax:

```
Permission x == Permission y
```

## Example

```
Permission all = read|create|modify|delete|control
```

---

## Access status

---

### Declaration

```
bool read(AccessRec ar)
```

```
bool create(AccessRec ar)
```

```
bool modify(AccessRec ar)
```

```
bool delete(AccessRec ar)
```

```
bool control(AccessRec ar)
```

```
bool write(AccessRec ar)
```

```
bool change(AccessRec ar)
```

### Operation

Each of the first five functions returns `true` if the access record confers modify, create, delete, control, or read permission. Both `write` and `change` are supported for compatibility with earlier releases; `write` returns `true` if the access record confers modify permission, and `change` returns `true` if the access record confers control permission. If the specified permission is not present, each function returns `false`.

**Note:** When using these functions with groups, any information returned for create permission is redundant as there is no create permission on groups.

---

## partition

---

### Declaration

```
bool partition(AccessRec ar)
```

## Operation

Returns `true` if the data that is associated with the access record has been partitioned out.

## get, getDef, getVal

### Declaration

```
AccessRec get({Object o|Module m|Project p|
              Folder f|Item i|View v|Group g},
              [AttrType at,]
              {string user|string group,
               string &message})
```

```
AccessRec get{Def|Val} (Module m,
                       AttrDef ad,
                       {string user|string group},
                       string &message)
```

### Operation

The first form returns the access record for object *o*, module *m*, project *p*, folder *f*, item *i*, view *v*, or group *g* for Rational DOORS user with name *user*, or group with name *group*. Optionally, for a module, the access record can be for a specific attribute type *at*.

The function `getDef` returns the access record for the attribute definition *ad* in module *m*.

The function `getVal` returns the access record for the attribute value of the attribute definition *ad* in module *m*.

For all these functions, the strings *user* or *group*, are the Rational DOORS user or group, to whom the access record applies. If they are null, the function returns the default access record. If the operation succeeds, returns a null string in *message*; otherwise, returns an error message.

If no specific access control setting has been made, these functions return null. However, a parent object or module setting might be being inherited.

## getImplied

### Declaration

```
string getImplied({Object o|Module m|Project p|Folder f|Item i}, Permission &ps)
```

### Operation

Returns the permissions that are inherited by children of the resource when the user has create permission to the resource (extra access propagated by create).

Returns the permissions inherited by children of object *o*, module *m*, folder *f*, item *i*, or view *v*. Optionally, when specifying a module, the permissions can be for a specific attribute type *at*.

If the operation succeeds, returns a null string; otherwise, returns an error message.

If no specific extra access setting has been made, these functions return null. However, a parent object or module setting might be being inherited.

---

## inherited, inheritedDef, inheritedVal

---

### Declaration

```
string inherited({Object o|Module m|Project p|Folder f|Item i|View v}
                [,AttrType at])
```

```
string inherited{Def|Val}(Module m, AttrDef ad)
```

### Operation

These functions set access control to be inherited rather than specific.

The first form does this for object *o*, module *m*, project *p*, folder *f*, item *i*, or view *v*. Optionally, for a module, the access record can be for a specific attribute type *at*.

The `inheritedDef` function does this for the attribute definition *ad* in module *m*. The `inheritedVal` function does it for the attribute value of the attribute definition *ad* in module *m*.

If the operation succeeds, returns null; otherwise, returns an error message.

---

## isAccessInherited

---

### Declaration

```
string isAccessInherited({Object o|Project p|Folder f|Item i|View v},
                        bool &inherited)
```

```
string isAccessInherited(Module m, [AttrType at,]bool &inherited)
```

```
string isAccessInherited{Def|Val}(Module m, AttrDef ad, bool &inherited)
```

### Operation

Returns whether the access rights are inherited.

The first form does this for object *o*, project *p*, folder *f*, item *i*, or view *v*.

The second form does this for module *m*. Optionally, the access record can be for a specific attribute type *at*.

The `isAccessInheritedDef` function does this for the attribute definition *ad* in module *m*. The `isAccessInheritedVal` function does it for the attribute value of the attribute definition *ad* in module *m*.

If the operation succeeds, returns null; otherwise, returns an error message.

---

## isDefault

---

### Declaration

```
bool isDefault(AccessRec ar)
```

### Operation

Returns `true` if `ar` is the default access record for a particular item; otherwise, returns `false`.

### Example

```
AccessRec ar
// process module (exclude inherited rights)
for ar in current Module do
{
    // only relevant if default
    if (isDefault(ar) == true)
    {
        // .. do stuff
    }
}
```

---

## set, setDef, setVal

---

### Declaration

```
string set({Object o|Module m|Project p|Folder f|Item i|View v|Group g},
           [AttrType at,]
           Permission ps,
           {string user|string group})
```

```
string set{Def|Val}(Module m,
                   AttrDef ad,
                   Permission ps,
                   {string user|string group})
```

### Operation

The first form sets permission `ps` on object `o`, module `m`, project `p`, folder `f`, item `i`, view `v` or Group `g`, for Rational DOORS user with name `user`, or group with name `group`. Optionally, for a module, the permission can be for a specific attribute type `at`.

The function `setDef` sets the permissions for the access list of the attribute definition `ad` in module `m`.

The function `setVal` sets the permission of all values of the attribute definition `ad` in module `m`.

For all these functions, if `user/group` is null, the function modifies the default access control. If the operation succeeds, it returns a null string; otherwise, it returns an error message. When retrieving access for an item and the user/group name retrieved is being assigned to a string, ensure that an empty string is appended to the end of the assigned string.

In some circumstances it might be possible to add the administrator user to a Rational DOORS access list. This should be guarded against.

### Example

```
set(current Object, read|modify|delete|control, doorsname)
```

## setImplied

### Declaration

```
string setImplied({Object o|Module m|Project p|Folder f|Item i},
                  Permission ps)
```

### Operation

Sets the extra access control propagated by create for children of the resource.

Sets permission *ps* on object *o*, module *m*, project *p*, folder *f*, item *i*, or view *v*.

If the operation succeeds, returns a null string; otherwise, returns an error message.

## specific, specificDef, specificVal

### Declaration

```
string specific({Object o|Module m|Project p|Folder f|Item i|View v},
               [AttrType at])
```

```
string specific{Def|Val}(Module m, AttrDef ad)
```

### Operation

These functions set access control to be specific rather than inherited. The item is left with specific access rights, which are identical to the inherited rights at the time the function is called. These functions have no effect if the access rights are already specific.

The first form does this for object *o*, module *m*, project *p*, folder *f*, item *i*, or view *v*. Optionally, for a module, the access rights can be for a specific attribute type *at*.

The `specificDef` function does this for the attribute definition *ad* in module *m*. The `specificVal` function does it for the attribute value of the attribute definition *ad* in module *m*.

If the operation succeeds, returns null; otherwise, returns an error message. If the user does not have control access, the call fails.

---

## unset, unsetDef, unsetVal, unsetAll

---

### Declaration

```
string unset({Object o|Project p|Module m| Folder f|Item i|View v|Group g},
             [AttrType at,]
             {string user|string group})

string unset{Def|Val}(Module m,
                     AttrDef ad,
                     {string user|string group})

string unsetAll({Object o|Project p|Module m| Folder f|Item i|View v|Group g},
                [AttrType at,])

string unsetAll{Def|Val}(Module m, AttrDef ad)
```

### Operation

The first form clears the permission set on object *o*, project *p*, folder *f*, item *i*, View *v*, or Group *g* for Rational DOORS user with name *user*, or group with name *group*.

The second form clears the permission set on module *m*. Optionally, clears the permission for a specific attribute type *at*.

The function `unsetDef` clears the permissions set for the access list of the attribute definition *ad* in module *m*.

The function `unsetVal` clears the permissions set for all values of the attribute definition *ad* in module *m*.

The function `unsetAll` clears all user permissions set for the specified argument.

The function `unsetAllDef` clears user permissions set for the access list of the attribute definition *ad* in module *m*.

The function `unsetAllVal` clears user permissions set for all values of the attribute definition *ad*.

If *user* (or *group*) is null, the call fails. If the operation succeeds, returns the null string; otherwise, returns an error message.

**Note:** Care should be taken when using these perms. The unsetting of the access controls is immediate, so if the user is removing specific access controls for an item, they must ensure that the default user has control access before use. Furthermore, care should be taken when using these perms in loops.

### Example

```
Module m = current
string err = unset(m, "joe")
if (!null err){
    infoBox(err)
}
```

---

## username

---

### Declaration

```
string username (AccessRec a)
```

### Operation

Returns the user name associated with the access record *a*. A null result means that access record *a* is the default record.

### Example

```
string mess
AccessRec a = get(current Object, null, mess)
if (null mess) {
    if (null a) {
        print "default record"
    } else {
        print (username a) "\n"
    }
} else {
    print "error getting access record: " mess
}
```

---

## for access record in type

---

### Syntax

```
for ar in type do {
    ...
}
```

where:

<i>ar</i>	is a variable of type AccessRec
<i>type</i>	is a variable of type Module, Object, Folder, Item, View, AttrDef, Group or AttrType

### Operation

Assigns the variable *ar* to be each successive access record in *type*, excluding inherited access rights.

### Example

```
AccessRec ar
for ar in current Object do {
    string user = username ar
}
```



```

    if (null user) {
        print "default"
    } else {
        print user
    }
    print " can read? " (read ar) "\n"
}

```

---

## for access record in all type

---

### Syntax

```

for ar in all type do {
    ...
}

```

where:

*ar* is a variable of type `AccessRec`

*type* is a variable of type `Module`, `Object`, `Folder`, `Item`, `View`, `AttrDef`, or `AttrType`

### Operation

Assigns the variable *ar* to be each successive access record in *type*, including inherited access rights.

---

## for access record in values

---

### Syntax

```

for ar in values(AttrDef ad) do {
    ...
}

```

where:

*ar* is a variable of type `AccessRec`

*ad* is a variable of type `AttrDef`

### Operation

Assigns the variable *ar* to be each successive record found for the list of attribute values obtained by passing the attribute definition *ad* to the function `values`.

### Example

```

AccessRec ar
AttrDef ad = find(current, "Object Heading")

```

```

for ar in values ad do {
    print (username ar) " can read " (read ar)
        "\n"
}

```

---

## Locking

This topic defines functions that are used in conjunction with access controls to implement shared access to modules.

In the context of access control, a section is defined as anything with a specific access control, along with everything that inherits that access control.

The lock manager functions are described in “Locking,” on page 927.

---

### isLockedByUser

---

#### Declaration

```
bool isLockedByUser(Object o)
```

#### Operation

Returns `true` if the specified object is locked by the current user when in edit shareable mode. Otherwise, returns `false`.

This function is not equivalent to checking whether the current user can modify the given object.

---

### lock(object)

---

#### Declaration

```
string lock(Object o)
```

#### Operation

Locks object `o`. If the operation succeeds, returns `null`; otherwise, returns an error message.

This function only makes sense when `o` is in a module that has been opened shareable.

#### Example

```

if (isShare current) {
    string mess = lock current Object
    if (!null mess)
        print "lock failed: " mess "\n"
}

```

---

## Unlock object functions

---

### Declaration

```
bool unlockDiscard{All|Section}(Object o)
```

```
bool unlockSave{All|Section}(Object o)
```

### Operation

These functions unlock sections. The functions `unlockDiscardAll` and `unlockSaveAll` unlock all sections in the module containing `o`. The functions `unlockDiscardSection` and `unlockSaveSection` unlock the section containing `o`.

The functions either discard changes or save changes before unlocking according to the function name.

If the operation is successful, returns `true`; otherwise, returns `false`.

---

## Example programs

This section contains two example programs.

---

### Setting access control example

---

This example shows how to set the default specific access rights, assuming the calling user has permission so to do.

```
// access control setting example
/*
  Example Access control setting program.
  Sets all objects in the current display set
  (i.e. respecting filtering, outlining, level,
  etc.) to have a specific access control, thus
  enabling them to be locked in shareable mode.
  Current module must be editable, and is then
  reopened shareable.
*/
if (null current Module) {
  ack "Please run this program from a module"
  halt
} else if (!isEdit current) {
  ack "current module must be editable to set
  permissions"
  halt
} else if ((level current Module)==0) {
  ack "Please set a specific level display\n" //-
  "all objects at this level will be made\n"
```

```

//-
    "lockable by giving them a specific
    default\n" //-
    "access control"
    halt
}
Object o
string modName = (current Module)."Name" ""
for o in current Module do {
    string err
    if (level o != level current Module)
        // just make selected level lockable
        continue
// alter the default ACL record
    err = set(o,read|modify|delete|control,null)
    if (!null err) {
        ack "problem setting default ACL: " err
        halt
    }
}
save current          // save our work
if (close current)
    share modName
// open with new lockable sections

```

---

## Reporting access control example

---

The following program illustrates some more access control features:

```

// access control example
/*
    Example Access Control DXL
*/
if (null current Module) {
    ack "Please run this program from a module"
    halt
}
// function to display an ACL record:
bool showAcl(string user, AccessRec acl, string type) {
    string thisuser = (username acl)

```

```

    if (thisuser != user) return false
    print "User: " user " has "
    bool something = false
    if (read acl) {
        something = true
        print "read "
    }
    if (modify acl) {
        something = true
        print "modify "
    }
    if (delete acl) {
        something = true
        print "delete "
    }
    if (control acl) {
        something = true
        print "control "
    }
    if (!something) print "no "
    print "powers on " type "\n"
    return true
}

string user = doorsname
AccessRec acl
bool found = false
for acl in current Module do {
    if (showAcl(user, acl, "current module")) {
        found = true
        break
    }
}
if (!found)
    print "default permission in current module\n"
found = false
for acl in current Object do {
    if (showAcl(user, acl, "current object")) {
        found = true
        break
    }
}
}

```

```
if (!found)
    print "default power on current object\n"
string fail
fail = set(current Module, change, user)
if (!null fail)
    print "Setting change failed for current
        module: " fail "\n"
```

## Chapter 22

# Dialog boxes

This chapter describes DXL facilities for creating Rational DOORS dialog boxes, which are any windows that are constructed by DXL. Throughout this manual, the term **dialog box** is used to mean Rational DOORS dialog box. This chapter covers the following facilities:

- Icons
- Message boxes
- Dialog box functions
- Dialog box elements
- Common element operations
- Simple elements for dialog boxes
- Choice dialog box elements
- View elements
- Text editor elements
- Buttons
- Canvases
- Complex canvases
- Toolbars
- Colors
- Simple placement
- Constrained placement
- Progress bar
- DBE resizing
- HTML Control
- HTML Edit Control

An extensive example of all dialog box functions can be found in `ddbintro.dxl` in the DXL example directory.

---

## Icons

This section defines constants and functions for using icons within dialog boxes. The functions use the `Icon` data type.

---

## Constants

---

### Declaration

Icon iconDatabase

Icon iconProject

Icon iconProjectCut

Icon iconProjectDeleted

Icon iconProjectOpen

Icon iconProjectOpenDeleted

Icon iconFormal

Icon iconFormalCut

Icon iconFormalDeleted

Icon iconLink

Icon iconLinkCut

Icon iconLinkDeleted

Icon iconDescriptive

Icon iconDescriptiveCut

Icon iconDescriptiveDeleted

Icon iconFolder

Icon iconFolderCut

Icon iconFolderDeleted

Icon iconFolderOpen

Icon iconFolderOpenDeleted

Icon iconDatabase

Icon iconGroup

Icon iconGroupDisabled

Icon iconUser

Icon iconUserDisabled

Icon iconReadOnly

Icon iconNone

Icon iconAuthenticatingUser



## Operation

These standard icon values can be used in functions where a value of type `Icon` is required. Icon constants starting `folder` are for tool bars; those starting `icon` are for list and tree views. Use the `set (icon)` function to specify an icon. Use the same function with `iconNone` to remove an icon. You can also load icons from disk. For further information, see the `load` function.

## Example

```
set (theTab, 0, iconDatabase)
```

## load

### Declaration

```
Icon load(string fileName)
```

### Operation

Loads an icon from disk. The *fileName* argument must be a full path.

For Windows platforms, if the file has an extension `.ico`, Rational DOORS assumes it is a Windows icon file; otherwise, Rational DOORS assumes it is a Windows bitmap.

Masks only work with icon files, not with bitmaps. An icon file should represent an image of either 16x16 or 32x32 pixels. The file should have no more than 8 bits per pixel (256 colors).

On UNIX platforms, icon files are `.xpm` (X PixMap) files; icons are Motif Pixmaps. For further information, see the XPM documentation.

### Example

```
Icon i = load("c:\\test.ico")
set (theTab, 0, i)
```

## destroy(icon)

### Declaration

```
void destroy(Icon iconName)
```

### Operation

Frees up resources used by *iconName*. Use this when you destroy a dialog box; for further information, see the `destroy(dialog box)` function.

### Example

```
Icon ic = load("c:\\test.ico")
set (theTab, 0, ic)
// .. then on program close
destroy ic
```

---

## Message boxes

This section defines functions that create message boxes. Message boxes provide a convenient way of informing users of events, such as confirmations or errors. The functions use the DB data type.

---

### acknowledge

---

#### Declaration

```
void ack[nnowledge] ([DB box,]
                    string message)
```

#### Operation

Pops up a message box containing the message and an **Acknowledge** or **OK** button, depending on platform, in a manner compatible with the rest of Rational DOORS. Execution of the DXL program is suspended until the user clicks **Acknowledge** or **OK**.

The optional DB *box* argument positions the message box over a specific dialog box.

#### Example

```
ack "Invalid weight supplied for grommet"
```

---

### errorBox

---

#### Declaration

```
void errorBox ([DB box,]
              string message)
```

#### Operation

Pops up a message box containing the error and an **Acknowledge** or **OK** button, depending on platform, in a manner compatible with the rest of Rational DOORS. Execution of the DXL program is suspended until the user clicks **Acknowledge** or **OK**.

The optional DB *box* argument positions the message box over a specific dialog box.

#### Example

```
errorBox "Path does not exist"
```

---

### infoBox

---

#### Declaration

```
void infoBox ([DB box,]
             string message)
```

## Operation

Pops up a message box containing information and an **Acknowledge** or **OK** button, depending on platform, in a manner compatible with the rest of Rational DOORS. Execution of the DXL program is suspended until the user clicks **Acknowledge** or **OK**.

The optional `DB box` argument positions the message box over a specific dialog box.

## Example

```
infoBox "Insufficient space on specified drive"
```

## warningBox

### Declaration

```
void warningBox([DB box,]
               string message)
```

### Operation

Pops up a message box containing the warning and an **Acknowledge** or **OK** button, depending on platform, in a manner compatible with the rest of Rational DOORS. Execution of the DXL program is suspended until the user clicks **Acknowledge** or **OK**.

The optional `DB box` argument positions the message box over a specific dialog box.

### Example

```
warningBox "This deletes all files - continue?"
```

## confirm

### Declaration

```
bool confirm([DB box,]
            string message,
            int severity)
```

### Operation

Pops up a confirmation box containing the message and buttons labeled **Confirm** and **Cancel**. The *severity* argument controls the icon displayed in the message box; the value can be one of `msgInfo` (blue **i**), `msgWarning` (red **X**), `msgError` (yellow **!**), or `msgQuery` (black **?**). The DXL program is suspended until the user clicks one of the buttons, when the function returns `true` for **Confirm** and `false` for **Cancel**.

**Note:** The use of `\t` within the *message* string is not supported.

The optional *box* argument positions the message box over a specific dialog box.

### Example

```
if (confirm "Delete all records?")
    deleteRecords
```

---

## query

---

### Declaration

```
int query([DB box,]
          string message,
          string[] buttons)
```

### Operation

Displays a message box with the message and buttons with the labels provided in the string array. The DXL program is halted until the user clicks one of the buttons, when the function returns with the index for that button.

The optional `DB box` argument positions the message box over a specific dialog box.

### Example

```
string analyopts[] = {"Linear", "Quadratic",
                    "Spline"}

int mode = query("Select analysis model",
                analyopts)

if (mode == 0) {
    doLinearAnalysis
} else if (mode == 1) {
    doQuadraticAnalysis
} else {
    doSplineAnalysis
}
```

---

## messageBox

---

### Declaration

```
int messageBox([DB box,]
               string message,
               string buttons[],
               int severity)
```

### Operation

Displays a message box with the message, and buttons with the labels provided in the string array. The *severity* argument controls the title of the message box; the value can be one of `msgInfo` (blue **i**), `msgWarning` (red **X**), `msgError` (yellow **!**), or `msgQuery` (black **?**). The DXL program is halted until the user clicks one of the buttons, when the function returns with the index for that button.

The optional `DB box` argument positions the message box over a specific dialog box.

### Example

```
string buttons[] = {"Yes", "No", "Cancel"}
```

```
int answer = messageBox("Do you want save?",
                        buttons, msgQuery)

print answer

confirm("Really?", msgWarning)
```

---

## Dialog box functions

This section defines functions for dialog boxes, which are built around the data type DB. Dialog boxes contain elements, such as buttons, fields or labels, which are represented by the data type DBE.

---

### addAcceleratorKey

---

#### Declaration

```
void addAcceleratorKey(DB db, void dxlCallback(), char accelerator, int
modifierKeyFlags)
```

#### Operation

Adds an accelerator key *accelerator* to the dialog *db* with the callback function `dxlCallback()` and the passed-in `modifierKeyFlags`. `modifierKeyFlags` is used in conjunction with the `accelerator` parameter to change which key should be pressed with the accelerator key. Possible values for it are `modKeyNone`, `modKeyCtrl`, `modKeyShift` and `null`.

The specified DXL callback fn `dxlCallback()` executes for the specified keystroke combination being pressed when the DXL dialog box *db* is active.

Only call this perm after the dialog box *db* has been realized, otherwise a DXL run-time error will occur.

#### Example

```
void fn()
{
    print "callback fires\n"
}

DB db = create("testDialog", styleStandard)
realize db

// The callback fn() will be executed on pressing Shift+F7 when the dialog db is
active.
addAcceleratorKey(db, fn, keyF7, modKeyShift)
```

---

## baseWin

---

### Declaration

```
void baseWin(DB box)
```

### Operation

This function is only for use in batch mode.

Displays the dialog box and suspends execution of the DXL program. Execution continues in callbacks from the buttons on the dialog box. No code should be placed after a call to `baseWin`, because it would never be executed.

---

## block

---

### Declaration

```
void block(DB modalBox)
```

### Operation

Displays a modal dialog box. When a modal dialog box is displayed, the rest of the Rational DOORS interface is insensitive, leaving only the given dialog box able to receive input. The interface remains in this state until either the dialog box is closed or the `release` function is called.

Unlike `show`, DXL program execution is resumed after the call to `block` when the modal dialog box is released.

### Example

```
block importantQuesBox  
processResult
```

---

## busy

---

### Declaration

```
void busy(DB box)
```

### Operation

Sets the window busy, displaying the waiting cursor and making it insensitive to input. Use the `ready` function to reset the dialog box to normal.

### Example

```
busy stressResultsBox
```

---

## centered

---

### Declaration

```
DB cent[e]red(string title)
```

### Operation

Creates a dialog box that is centered on the screen. Nothing appears on the screen until it is passed to either the `block` or `show(dialog box)` function, when the dialog box window title bar contains *title*.

### Example

```
DB splashBox = centered "Welcome to Example"
```

---

## create(dialog box)

---

### Declaration

```
DB create([Module|DB] parent,]
          string title
          [,int options])
```

### Operation

Creates a new, empty dialog box structure. Nothing appears on the screen until it is passed as an argument to `show`, when the dialog box window title bar contains *title*.

The optional first argument creates a child window of the module or dialog box specified by *parent*. When a child window is hidden, its parent is put in front of any other windows. The optional third argument defines the style of the dialog box; it can have bitwise OR combinations of the following values:

Constant	Meaning
<code>styleStandard</code>	Appears like other Rational DOORS windows.
<code>styleFixed</code>	Has no resizing capability.
<code>styleCentered</code>	Appears in the center of the screen.
<code>styleCentred</code>	Appears in the center of the screen.
<code>styleFloating</code>	Appears above all other Rational DOORS windows.
<code>styleNoBorder</code>	Has no title bar or resizing capability.
<code>styleThemed</code>	Inherits themed styles into tabs
<code>styleAutoParent</code>	Automatically set the parenting of controls based on layout information

---

## Example

```
DB parseBox = create("Sim File Parser", styleCentered|styleFixed)
label(parseBox, "Nothing in here yet")
show parseBox
```

---

## createButtonBar

---

See “createButtonBar,” on page 635.

---

## createItem

---

See “createItem,” on page 635.

---

## createCombo

---

See “createCombo,” on page 640.

---

## destroy(dialog box)

---

### Declaration

```
void destroy(DB box)
```

### Operation

Frees up resources used by *box*. The specified *box* should not be used after it has been destroyed without being re-initialized. After using `destroy`, you should set *box* to `null`.

If the dialog box used icons, you should also destroy them using the `load` function.

**Note:** Destroy should not be used within a callback function for a DBE.

---

## getPos

---

### Declaration

```
void getPos(DB myWindow,
            int& x,
            int& y)
```

### Operation

Returns in *x* and *y* the screen co-ordinates of the origin of the specified window.



---

## getSize

---

### Declaration

```
void getSize(DB myWindow,  
            int& w,  
            int& h)
```

### Operation

Returns in *h* and *w* the height and width of the specified window. Dimensions are returned in pixels.

---

## getTitle

---

### Declaration

```
string getTitle(DB myWindow)
```

### Operation

Returns the title of the specified window.

---

## getBorderSize

---

### Declaration

```
int getBorderSize(DB myWindow)
```

### Operation

Returns the width in pixels of the border for the specified dialog box.

### Example

```
DB DBox = create("Dialog Box", styleCentered|styleFixed)  
int i = getBorderSize(DBox)  
label(DBox, "Border size is " i "")  
  
show DBox
```

---

## getCaptionHeight

---

### Declaration

```
int getCaptionHeight(DB myWindow)
```

## Operation

Returns the height in pixels of the caption area for the specified dialog box.

## Example

```
DB DBox = create("Dialog Box", styleCentered|styleFixed)
int i = getCaptionHeight(DBox)
label(DBox, "Caption height is " i "")

show DBox
```

## help, gluedHelp

### Declaration

```
void {gluedH|h}elp(DB box,
                  int index)
```

### Operation

Adds a **Help** button to a dialog box *box*. When the user clicks the button, help is activated displaying the entry identified by the *index* number.

The optional second argument associates the **Help** button with the named *helpFile* and an entry *index* in it. The help file must be in the appropriate format for the platform and must be referenced by a full path name; a relative path does not work in this case. This can be used to add user-defined help information to Rational DOORS.

When a dialog box has a large number of buttons, the `gluedHelp` function is used to link the help button to the last button, to prevent them from overlapping.

These functions can only refer to help entries in the standard Rational DOORS help file, `DOORS.HLP`. In addition the following standard values can be used to obtain help system functions:

- |   |               |
|---|---------------|
| 1 | Contents page |
| 2 | Help on help  |
| 3 | Search help   |

### Example

```
help(simParse, 301)
help(simParse, "SIMPARSE.HLP", 1)
```

## hide(dialog box)

### Declaration

```
void hide(DB box)
```

## Operation

Removes dialog box *box* from the screen.

## Example

```
hide thisBox
```

## raise

### Declaration

```
void raise(DB box)
```

### Operation

Brings dialog box *box* to the top, over all other windows.

### Example

```
raise tempBox
```

## setFocus

### Declaration

```
void setFocus(Module m)
```

### Operation

Sets the windows focus on the module *m*.

## ready

### Declaration

```
void ready(DB box)
```

### Operation

Used after a call to `busy`, this function makes dialog box *box* sensitive to input again, and removes the waiting cursor.

### Example

```
ready graphBox
```

## realize(pending)

### Declaration

```
void realize(DB box)
```

## Operation

Creates and displays the dialog box without suspending execution of the DXL program. The dialog box only becomes active when a `show` function is called, either for this dialog box or another.

This function is used where you wish to do something that can only be done once the dialog box internal structure has been created, for example, add columns to a list view. Creating the internal structure is called *realization*.

## Example

```
realize infoBox
```

## realize(show)

### Declaration

```
void realize(DB myWindow,
            int x,
            int y)
```

### Operation

Creates the specified window and initializes its origin to the co-ordinates  $(x, y)$ .

## release

### Declaration

```
void release(DB modalBox)
```

### Operation

Hides the modal dialog box *modalBox*, and resumes execution of the DXL program after the call to `block`. The Rational DOORS interface then becomes operative.

### Example

```
release importantQuesBox
```

## show(dialog box)

### Declaration

```
void show(DB box)
```

### Operation

Displays the dialog box and suspends execution of the DXL program. Execution only continues in callbacks from the buttons on the dialog box. No code should appear after a `show` as it would never be executed.

### Example

```
show splashBox
```

---

## showing

---

### Declaration

```
bool showing(DB box)
```

### Operation

Returns `true` if *box* is displayed as a result of a call to `show` or `realize`.

### Example

```
if (showing infoBox) { ... }
```

---

## getParent

---

### Declaration

```
{DB|DBE} getParent(DBE element)
```

### Operation

Returns the parent dialog box or dialog box element of the specified dialog box element. This is useful in callback functions.

If the function that returns an object of type DBE is called, and the parent is not an object of type DBE, the function returns `null`.

### Example

```
void takeAction(DBE button) {  
    DB enclosedby = getParent button  
    // user code here  
} // takeAction
```

---

## setParent

---

### Declaration

```
void setParent(DB box|DBE child,  
              {DB|DBE|Module} parent)
```

### Operation

Sets the parent of *child* to be *parent*.

The only type of DBE which can be the parent of another DBE, is a frame.

---

## setPos

---

### Declaration

```
void setPos(DB myWindow,  
            int x,  
            int y)
```

### Operation

Sets the screen co-ordinates of the origin of the specified window to the co-ordinates (*x*, *y*).

---

## setCenteredSize

---

### Declaration

```
void setCenteredSize(DB box,  
                    int width,  
                    int height)
```

### Operation

Sets the width and height of *box* to *width* and *height* pixels, independently of any styles used, such as *styleCentered* or *styleFixed*.

This function must be placed after a call to the *realize* (pending) function, and before any further call to either the *show*(*dialog box*) or *block* functions.

### Example

```
DB dlg = create("Test Window", styleCentered |  
               styleFixed)  
  
realize dlg  
// both width and height are specified in pixels  
setCenteredSize(dlg, 300, 100)  
show dlg
```

---

## setSize

---

### Declaration

```
void setSize(DB myWindow,  
            int w,  
            int h)
```

### Operation

Sets the width and height of the specified window to the values in *w* and *h*. Dimensions are specified in pixels.

---

## setTitle

---

### Declaration

```
void setTitle(DB myWindow,  
             string newTitle)
```

### Operation

Sets the title of the specified window to *newTitle*. This function is used after the window is created.

---

## setBaseWindowContext

---

### Declaration

```
void setBaseWindowContext()
```

### Operation

Used when displaying dialog boxes in batch mode. This enables the use of *realize()* for populating DBEs.

---

## startConfiguringMenus

---

### Declaration

```
void startConfiguringMenus({DB box|DBE element})
```

### Operation

Starts menu creation and configuration in *box* or *element*. To stop menu creation and configuration for a dialog box element, use the *stopConfiguringMenus* function. For a dialog box, the menu configuration stops when the dialog box is shown.

---

## stopConfiguringMenus

---

### Declaration

```
string stopConfiguringMenus(DBE element)
```

### Operation

Disables menu creation and configuration functions for the specified dialog box element. To start menu creation and configuration, use the *startConfiguringMenus* function.

---

## topMost

---

### Declaration

```
DB topMost(string title)
```

### Operation

Creates a dialog box that always stays on top of all other windows. This can be used instead of the `create(dialog box)` function.

### Example

```
DB top = topMost "TOPMOST"  
label(top, "I am on top!")  
show top
```

---

## hasFocus

---

### Declaration

```
bool hasFocus(DBE toolbar)
```

### Operation

Returns `true` if the supplied `toolbar` DBE contains an element that currently has the keyboard focus. Otherwise, returns `false`.

---

## setDXLWindowAsParent

---

### Declaration

```
void setDXLWindowAsParent(DB dialog)
```

### Operation

Sets the DXL interaction window to be the parent of `dialog`. If there is no DXL interaction window, the parent is set to `null`.

---

## minimumSize

---

### Declaration

```
void minimumSize(DB box, int width, int height)
```

### Operation

Sets the minimum size of the dialog `box` to be `width` and `height`.



Negative values are ignored. A width value of 200 and a height value of -1 only sets the minimum width for the dialog box. Note the dialog box does not need to be realized to set the minimum size.

### Example

```
DB db = create "hello"  
realize db  
minimumSize(db, 400, 100)  
show db
```

---

## Dialog box elements

Dialog box elements define the components of a dialog box. These are called *controls* on Windows, and *Widgets* on Motif, the most common user interface tool kit on UNIX.

Dialog box elements provide a wide range of capability, although all have the DBE data type. This manual groups the functions for DXL dialog box elements into the following categories:

- Common element operations
- Simple elements for dialog boxes
- Choice dialog box elements
- View elements
- Text editor elements
- Buttons
- Canvases
- Complex canvases

---

## Common element operations

This section defines element operations. Unless otherwise specified, these functions can be used with *all* dialog box elements.

For dialog box elements, the `set` function has many different variants, all of which are defined in this section. There are pointers to the appropriate `set` function from other sections within this chapter.

---

## addMenu

---

### Declaration

```
void addMenu(DBE element,
            string title,
            char mnemonic,
            string entries[ ],
            char mnemonics[ ],
            char hots[ ],
            string help[ ],
            string inactiveHelp[ ]
            [, int noOfEntries,]
            Sensitivity sensitive(int entryIndex),
            void callback(int entryIndex))
```

### Operation

Adds a menu to a menu bar, canvas, list view, or tree view. If *element* is a menu bar, the new menu appears after any other menus. If *element* is a canvas, list view, or tree view, the new menu is activated by a right click. For further information on creating the dialog box elements that can take menus, see the `menuBar`, `canvas`, `listView`, and `treeView` functions.

The arguments passed are divided into two sets: those that define the menu, and those that define the menu entries, which are specified as arrays. To use fixed-size arrays all containing the same number of elements, omit *noOfEntries*. To use freely-defined arrays, specify the minimum number of elements in *noOfEntries*.

The arguments passed to the function are defined as follows:

<i>element</i>	The menu bar or canvas in which the menu is to appear; this is returned by a call to the <code>menuBar</code> or <code>canvas</code> function.
<i>title</i>	The title of the menu, as it appears in the menu bar.
<i>mnemonic</i>	The keyboard access character, normally shown underlined, which activates the menu when pressed with ALT; the value <code>ddbNone</code> means that there is no mnemonic.
<i>entries</i>	The strings that appear in the menu.
<i>mnemonics</i>	The keyboard access character for this option, normally shown underlined, which activates the option when pressed with ALT; the value <code>ddbNone</code> indicates that there is no mnemonic.
<i>hots</i>	A hot key that directly activates the option when pressed with CTRL; for example, if the value of <code>hots[3]</code> is S, CTRL+S activates the third option of the menu; the value <code>ddbNone</code> indicates that there is no hot key.

<i>help</i>	String that is displayed in the status bar of the window, if one exists, when the user passes the mouse over an active menu item.
<i>inactiveHelp</i>	String that is displayed in the status bar of the dialog box, if one exists, when the user passes the mouse over an inactive menu item.

You can construct one level of cascading menus by placing a right angle bracket (>) character at the start of an option name, indicating that it is a member of a sub-menu:

```
const string formatMenu[] = {"Size",
                             ">Small",
                             ">Normal",
                             ">Large",
                             "Style",
                             ">Bold",
                             ">Italic"}
```

This constructs a cascading menu. The first cascading menu, `Size`, opens out, followed by the second cascading menu, `Style`.

Finally, two callback functions are required: one to determine whether menu items are sensitive, and one that is called when a menu option is activated.

The function `sensitive(int entryIndex)` is called for each option, each time the menu is displayed. The function must return one of the following values:

<b>Availability</b>	<b>Meaning</b>
<code>ddbUnavailable</code>	The menu option is grayed out.
<code>ddbAvailable</code>	The menu option is active.
<code>ddbChecked</code>	The menu entry is active and has a check beside it.

When the user selects an option, `callback(int entryIndex)` is called with the index of the option, and your program must perform the appropriate operation. For both `sensitive` and `callback` functions, `entryIndex` starts at 0, and counts up, including cascading menu entries, so there is a direct correspondence between the array elements and the index returned by the menu.

---

## active

---

### Declaration

```
void active(DBE element)
```

### Operation

Sets an item active, restoring it from being grayed out and enabling users to interact with it. This is the opposite of the `inactive` function. The `active` function can be used with any kind of dialog box element.

## Example

```
if (gotFileName) active startLoader
```

---

## inactive

---

### Declaration

```
void inactive(DBE)
```

### Operation

Sets an item inactive, displaying it in gray and preventing users from interacting with it. This is the opposite of the `active` function. The `inactive` function can be used with any kind of dialog box element.

### Example

```
if (dataNotComplete) inactive verify
```

---

## hide

---

### Declaration

```
void hide(DBE element)
```

### Operation

Hides a single dialog box element.

### Example

```
hide showAdminButtons
```

---

## setGotFocus

---

### Declaration

```
void setGotFocus(DBE element, void callback(DBE element))
```

### Operation

Sets the callback function to call when `element` gets input focus. Currently, `element` must be a list view or tree view on a Windows platform.

---

## setLostFocus

---

### Declaration

```
void setLostFocus(DBE element, void callback(DBE element))
```

## Operation

Sets the callback function to call when *element* loses input focus. Currently, *element* must be a list view or tree view on a Windows platform.

## show(element)

### Declaration

```
void show(DBE element)
```

### Operation

Makes a single dialog box element visible again.

### Example

```
show showAdminButtons
```

## delete(option or item)

### Declaration

```
void delete(DBE element, int index)
```

### Operation

Deletes the option in *element* at the given *index*. The argument *element* can be a choice, tab strip, list, multi-list, combo box, or list view. Positions start at *zero*; when an element is deleted, all the others are moved down. The last element cannot be deleted in a tab strip. To delete all items in a list or list view, use the `empty` function.

### Example

```
delete(components, obsoleteEntry)
```

## delete(item in tree view)

### Declaration

```
void delete(DBE treeView, string path)
```

### Operation

Deletes the item pointed to by *path*, which must be an absolute path.

### Example

```
delete(treeView, "Project/Module1")
```

---

## empty

---

### Declaration

```
void empty(DBE element)
```

### Operation

Deletes all items in a list, multi-list, choice, combo box, list view or tree view.

### Example

```
empty listView1
```

---

## insert(option or item)

---

### Declaration

```
void insert(DBE element, int index, string value)
```

### Operation

Inserts a new *value* into *element* at position *index*. The argument *element* can be a choice, tab strip, list, multi-list, combo box, or list view. Positions start at zero; when a new element is inserted all the other values are moved up. This function inserts duplicate values if they are specified.

### Example

```
insert(months, 4, "May")
```

---

## insert(item in list view)

---

### Declaration

```
void insert(DBE listView, int row, string value, Icon icon)
```

### Operation

Inserts a new item with the specified string *value* into the list view, at the zero based row number. The icon is the icon that appears to the left of the string *value* on the specified row.

---

## insert(item in tree view)

---

### Declaration

```
void insert(DBE treeView, string path, Icon normal, Icon selected)
```

## Operation

Inserts the item pointed to by *path* into *treeView*. The third and fourth arguments define icons for the item when it is not selected and selected, respectively. To make the selected icon the same as the normal icon, use `iconNone` as the value for *selected*. For valid icon values, see “Icons,” on page 481.

Note that the slash character has a special meaning when included in a string to be inserted: it represents a parent-child relationship. So adding “Heading1” then “Heading1/sub1” will add “Heading1” as a top-level entry, and “sub1” as a child entry under it.

## Example

```
insert(treeView, newFolder, iconFolder, iconFolderOpen)
```

## noElems

### Declaration

```
int noElems(DBE element)
```

### Operation

Returns the number of options or items in *element*. The argument *element* can be a choice, tab strip, list, multi-list, combo box, or list view.

### Example

```
int noOfResources = noElems resourceList
string listContents[noOfResources]
int i
for (i = 0; i < noOfResources; i++)
    listContents = get(resourceList, i)
```

## select(element)

### Declaration

```
void select(DBE textElement, int start, int end)
```

### Operation

Selects text only in a rich text or rich field dialog box element.

## selected(element)

### Declaration

```
bool selected(DBE element, int index)
```

## Operation

Returns `true` if the option or item identified by `index` is selected; otherwise returns `false`. The argument `element` can be a list, multi-list, or list view.

## Example

```
if (selected(products, ownBrand))
    print "Using own brand\n"
```

## selected(item)

### Declaration

```
bool selected(DBE treeView, string path)
```

### Operation

Returns `true` if the item pointed to by `path` is selected; otherwise returns `false`. The argument `path` must be an absolute path.

## get(element or option)

### Declaration

```
{string|int|bool} get(DBE element [,int index])
```

### Operation

For a multi-list element, returns a value for the most recently selected/de-selected item. For all other elements, with one argument, returns a value for the first or only selected element of the appropriate type. The optional second argument is available only for a string return type and list views or choice dialog box elements. Use it to specify a given item in a list view or a given position in a choice element. The return types and values for all dialog box elements are as follows:

Element	Return type	Contents of most recently selected/deselected option	Return value if no selection
canvas	not supported		
check box	int	integer defining which element or elements are checked; when converted to binary, the value is a bitmap for the selection of check boxes, for example, 5 (101) means first and third boxes checked	0
choice	string	contents of selection (chosen or typed) or contents of specified choice	null string



Element	Return type	Contents of most recently selected/deselected option	Return value if no selection
	int	index (position) of selected option except for typed entries, which return -1 even if the typed entry matches a selection. This is the preferred method when the value being retrieved is to be used elsewhere. The number should be used as the index to retrieve the value from the original string array.	-1
field	string	contents of field	null string
	bool	if the DBE is read only, returns true; otherwise, returns false	
file name	string	path in file selector	null string
frame	not supported		
list	string	contents of selected option or specified option	null string
	int	index (position) of selected option	-1
list view	string	value of selected item or specified item	null string
	int	index of selected item	
multi-list	string	contents of first selected option or specified option	null string
	int	index (position) of first selected option	
radio box	int	index of the selected option in the array	not applicable
rich field	string	contents of rich field	null string
	bool	if the DBE is read only, returns true; otherwise, returns false	
rich text	string	contents of rich text box	null string
	bool	if the DBE is read only, returns true; otherwise, returns false	
slider	int	integer in range specified	-1
tab strip	string	name	not applicable
	int	index (position) of currently selected tab	not applicable

Element	Return type	Contents of most recently selected/deselected option	Return value if no selection
text	string	contents of text box	null string
	bool	if the DBE is read only, returns true; otherwise, returns false	
toggle	bool	true	false
tree view	string	full path of selected item	null string

You can find out the read-only status of a text or string DBE using `get` in a boolean expression.

### Example

```
DB exBox = create "Use of Get"
DBE intIn = slider(exBox, "Integer:", 50, 0, 100)
DBE stringIn = field(exBox, "String:", "Example",
                    20)
void doGet(DB exBox) {
    int i = get intIn
    string s = get stringIn
    print i ", " s "\n"
} // doGet
apply(exBox, "Get", doGet)
show exBox
```

---

## setTextChangeCB

---

### Declaration

```
void setTextChangeCB(DBE, void callbackFn (DBE))
```

Sets the text change callback for field, richField, text, richText DBEs where the callback is of the form `void callbackFn (DBE)`.

When the callback function is invoked on a text change, DBE will be the handle of the edit control DBE, which can be field, richField, text or richText.

Calling this perm using any type of DBE other than these four, leads to a run-time DXL error.

### Example

```
DB db
```

```

db = create("hello world", styleCentered | styleStandard)
DBE dbe = field(db, "label", "", 34, false)
int count = 0
void cb(DBE dbe)
{
    count++
    string str = plainText(get(dbe))
    print count "). The edit text now is \"\" str \"\".

}
setTextChangeCB(dbe, cb)
void checkText(DB db)
{
    hide db
}
ok(db, "Cancel", checkText)
close(db, false, checkText)
show db

```

---

## toolBarEditGetString

---

### Declaration

```
string toolBarEditGetString(DBE tb, int index)
```

Gets the contents of the edit control hosted on the toolbar with DBE handle *tb*, where *index* identifies the edit control on this toolbar by the index of the edit control.

### Example

```

#include "utils/icons.inc"
DB db = create("hello", styleStandard)
ToolType types[] = {toolEditField, toolToggle, toolToggle, toolToggle,
toolToggle, toolToggle}
Sensitivity mappingCallback()
{
    return ddbAvailable
}

```

```

bool toggleStates[6] = {false, true, true, true, true, true}
int param[] = {100, ICD_SAVE, ICD_PRINT, ICD_TEXTBOLD, ICD_TEXTBULLET,
ICD_TEXTITALIC}
string toolTip[] = {"first", "second", "third", "fourth", "fifth", "six"}
string help[] = {"firsthelp", "secondhelp", "thirdhelp", "comboonehelp",
"fourthhelp", "combotwohelp"}
string inactiveHelp[] = {"firstinchhelp", "secondinchhelp", "thirdinchhelp",
"combooneinchhelp", "fourthinchhelp", "combotwoinchhelp"}
DBE tb = null
Sensitivity sensitive(int entryIndex)
{
    if (types[entryIndex] == toolEditField)
    {
        return ddbAvailable
    }
    if (null toolBarEditGetString(tb, 0))
    {
        return ddbUnavailable
    }
    if (toggleStates[entryIndex])
    {
        return ddbChecked
    }
    return ddbAvailable
}
int iCount = 0
void callback(int entryIndex)
{
    if (types[entryIndex] == toolEditField)
    {
        iCount++
        print iCount "). String in edit box with index " entryIndex " is \"
toolBarEditGetString(tb, entryIndex) \"\").

        if (null toolBarEditGetString(tb, 0))

```

```
        {
            toggleStates[1] = true
            toggleStates[2] = true
            toggleStates[3] = true
            toggleStates[4] = true
            toggleStates[5] = true
        }
        updateToolBars(db)
    }
    else if (types[entryIndex] == toolToggle)
    {
        toggleStates[entryIndex] = (!toggleStates[entryIndex])
    }
}
tb = toolBar(db,
"tbname",
mappingCallback,
types,
param,
toolTip,
help,
inactiveHelp,
6,
sensitive,
callback,
true,
true)
realize db
setSize(db, 500, 500)
updateToolBars(db)
show db
```

---

## get(selected text)

---

### Declaration

```
bool get(DBE textElement, int &first, int &last)
```

Applies only to text dialog box elements. It returns *true* if there is a selected area of text; otherwise, returns *false*. If it returns *true*, the integers return the start and finish indices of the selected text, starting from 0. For example, if the first ten characters are selected, *first* and *last* contain 0 and 9.

---

## set(value or selection)

---

### Declaration

```
void set(DBE element, {string|int|bool} value)
```

```
void set(DBE currDBE, Buffer b)
```

### Operation

The first form sets either the value of an element or the status of the selected element as follows

The second form sets the content of the specified DBE to be the content of the Buffer.:

Element	Type	Action
canvas	not supported	
choice	int	Sets the selected option.
check box	int	Sets the selected option.
field	string	Sets the contents.
	bool	When <i>true</i> , sets field read only; otherwise, sets field read/write.
file name	string	Sets the contents.
frame	string	Sets the contents.
label	string	Sets the contents.
list	int	Sets the selected option.
list view	int	Sets the selected item.
multi-list	int	Sets the selected option.
text	string	Sets the contents.
	bool	When <i>true</i> , sets text read only; otherwise, sets text read/write.
radio box	int	Sets the selected item.

---

Element	Type	Action
rich field	string	Sets the contents.
	bool	When true, sets field read only; otherwise, sets field read/write.
rich text	string	Sets the contents.
	bool	When true, sets text read only; otherwise, sets text read/write.
slider	int	Sets the selected item.
status bar	string	Sets the contents.
tab strip	string	Sets the selected tab.
	int	Sets the selected tab.
toggle	bool	When true, sets toggle on; otherwise, sets toggle off.
tree view	string	Sets the selected item.

Using set with -1 deselects any selection in a list, choice or radio button dialog box element.

If these functions are used with an incorrect type DBE, a DXL run-time error occurs.

### Example

```
DB exBox = create "Use of Put"
DBE intOut = slider(exBox, "Integer:", 50, 0,
                  100)
DBE stringOut = field(exBox, "String:",
                    "Example", 20)
void doHigh(DB exBox) {
    set(intOut, 100)
    set(stringOut, "Max out")
} // doHigh
void doLow(DB exBox) {
    set(intOut, 0)
    set(stringOut, "")
} // doLow
apply(exBox, "Low", doLow)
apply(exBox, "High", doHigh)
show exBox
```

---

## set(selected status)

---

### Declaration

```
void set(DBE list, int index, bool selected)
```

### Operation

Sets the status of a selected item within a list or list view. identified by *index* in a list or list view. Valid items are ranged between position 0 and a number that can be obtained from:

```
noElems (DBE) -1
```

If this function is used with an incorrect type DBE, a DXL run-time error occurs.

---

## set(choice element values)

---

### Declaration

```
void set(DBE choice, string choices[ ] [,int noOfChoices])
```

### Operation

Sets a new range of values into a choice element. You can supply a complete array of strings or a partially filled array with the number of items supplied in the *noOfChoices* argument.

This works only with choice dialog box elements created with the *choice* function. If this function is used with an incorrect type DBE, a DXL run-time error occurs.

### Example

```
string attrNames[100]
int noOfAttrs = 0
string an
for an in current Module do
    attrNames[noOfAttrs++] = an
set(attrChoice, attrNames, noOfAttrs)
```

---

## set(item value)

---

### Declaration

```
void set(DBE listView, int item, int column, string value)
```

### Operation

Sets the value of a specific column item within a list view.

If this function is used with an incorrect type DBE, a DXL run-time error occurs.



---

## set(status bar message)

---

### Declaration

```
void set(DBE statusBar, int section, string message)
```

### Operation

Sets the value of a particular section within a status bar.

If you use `ddbFullStatus` as *section*, the string is displayed in the full width of the status bar, as with menu help. To return to normal display, specify `ddbFullStatus` with a null string for *message*.

If this function is used with an incorrect type DBE, a DXL run-time error occurs.

---

## set(file selector)

---

### Declaration

```
void set(DBE fileSelector, string desc, string exts)
```

### Operation

Sets the file selector description(s) and extension(s) for a dialog box file selector.

If this function is used with an incorrect type DBE, a DXL run-time error occurs.

### Example

```
DB b = create "File Selector DB"
DBE fs = fileName b
set(fs, "Comma separated files", "*.CSV")
show b
```

---

## set(icon)

---

### Declaration

```
void set(DBE element, int index, [int column,] Icon icon)
```

### Operation

Sets the displayed icon for either a tab in a tab strip or item in a list view that is identified by *index* to have the specified *icon*. The *column* argument must be passed for list views, but not for tab strips. For possible values of *icon*, see “Icons,” on page 481. Use this function with `iconNone` as the value for *icon* to remove an icon.

If this function is used with an incorrect type DBE, a DXL run-time error occurs.

### Example

```
set(linkList, 2, iconLink)
```

---

## set(select)

---

### Declaration

```
void set(DBE element, void select(DBE))
```

### Operation

Attaches a callback to any dialog box element other than a list view. The callback must be of the form:

```
void select(DBE option){
}
```

which fires when *option* changes.

The exact semantics vary depending on the type of element, but in principle it means a single click. For field elements, the callback only fires when the user clicks **Return** or **Enter** with the cursor in the field.

If this function is used with a list view, a DXL run-time error occurs.

### Example

This example adds a callback to a radio box.

```
DB boatBox = create "Craft"
string boats[] = {"Dinghy", "Destroyer",
                 "Carrier", "Mine sweeper"}
DBE boatCheck = radioButton(boatBox, "Select
                             class:", boats, 3)
void toBuild(DBE option) {
    int favorite = get option
    ack(boatBox, "You are planning a new "
        boats[favorite] "?")
} // toBuild
set(boatCheck, toBuild)
show boatBox
```

---

## set(key or mouse callback)

---

### Declaration

```
void set(DBE canvas, void callback(DBE canv,
                                   {char key|int button}
                                   bool controlDown,
                                   int x,
                                   int y))
```

## Operation

Attaches a callback to the specified canvas. The callback can be fired from character input or a mouse click, depending on the second argument passed to the callback function.

For a character input callback you must supply the code for the key, whether the control key was down, and the mouse position when the key was pressed. The key code is normally the ASCII character value, but might be one of a set of predefined constants (see “Keyboard event constants,” on page 558).

For a mouse click callback you must supply the canvas identifier, the mouse button number, starting from 1 for the left button, whether the control key was down, and the co-ordinates of the mouse at the time.

If this function is used with an incorrect type DBE, a DXL run-time error occurs.

## Example

This example adds a callback to a canvas.

```
// character input callback
DB typeBox = create "Type Something"
int col = 0
void redraw(DBE x) {
    draw(x, 20, 20, "Type something!")
} // redraw
DBE can = canvas(typeBox, 300, 300, redraw)
void key(DBE can, char k, bool ctrl, int x,
        int y) {
    color(can, col)
    if (k == keyF2) {
        col++
    } else if (k == keyF3) {
        background(can, col++)
    } else {
        draw(can, x, y, k "")
    }
    if (col > 29) col = 0
} // key
set(can, key)
show typeBox
// mouse button callback
DB drawBox = create "Test"
void redraw(DBE x) {
    draw(x, 20, 20, "Hello!")
} // redraw
DBE can = canvas(drawBox, 300, 300, redraw)
int lastX = -1
```

```

int lastY = -1
int firstX
int firstY
int col = 0
void btn(DBE can, int bt, bool ctrl, int x,
        int y) {
    if (bt == 1) {
        if (lastX > 0) {
            line(can, lastX, lastY, x, y)
        } else {
            rectangle(can, x, y, 1, 1)
            firstX = x
            firstY = y
        }
        lastX = x
        lastY = y
    } else if (bt == 2) {
        lastX = -1
    } else if (bt == 3) {
        col++
        if (col > 29) col = 0
        color(can, col)
    }
} // btn
set(can, btn)
show drawBox

```

---

## set(select and activate)

---

### Declaration

```
void set(DBE element, void select(DBE), void activate(DBE))
```

### Operation

Attaches two callback functions to a list or tree view.

The first callback fires when an item is selected (a single click); the second fires when an item is activated (a double click).

Both callbacks must be of the form:

```
void callback(DBE item) {
}

```

If this function is used with an incorrect type DBE, a DXL run-time error occurs.

## Example

```

DB listBox = create "The Good Numbers"
string states[]={"New Jersey", "Virginia", "Texas", "California", "Europe"}
string phones[]={"201 442-4600", "703 904-4360", "817 588-3008", "408 879-2344",
"+44 1865 784285"}
DBE abcList = list(listBox, "ABC Offices:", 200, 4, states)
full listBox
DBE telNo = field(listBox, "Telephone:", "", 30, true)
void onSelection(DBE l) {
    int sel = get abcList
    if (sel >= 0) {
        set(telNo, phones[sel])
    } else {
        set(telNo, "")
    }
} // onSelection
void onActivate(DBE l) {
    int sel = get abcList
    if (sel >= 0) {
        ack(listBox,
            "Calling ABC in " states[sel] " on "
            phones[sel])
    }
} // onActivate
set(abcList, onSelection, onActivate)
show listBox

```

---

## set(list view callback)

---

### Declaration

```
void set(DBE listView, void callback(DBE, int))
```

### Operation

Attaches a callback to a check box within a list view, provided the list view was created with check boxes (using the `listViewOptionCheckboxes` style). The callback must be of the form:

```
void select(DBE listView, int selected) {
}
```

which fires when the state of any check box changes. The *selected* argument identifies the item that changed.

If this function is used with an incorrect type DBE, a DXL run-time error occurs.

---

## set(select, deselect, and activate)

---

### Declaration

```
void set(DBE listView,
        void select(DBE, int),
        void deselect(DBE, int),
        void activate(DBE, int))
```

### Operation

Attaches three callback functions to a list view.

The first callback fires when an option is selected (a single click); the second fires when an option is deselected (a side effect of a single click on another item); the third fires when an item is activated (a double click).

All callbacks must be of the form:

```
void select(DBE listView, int selected){
}
```

If this function is used with an incorrect type DBE, a DXL run-time error occurs.

---

## set(sort function)

---

### Declaration

```
void set(DBE listView,
        int columnIndex,
        int dxlSortFn(string, string))
```

### Operation

Attaches a sort function to a specific column within a list view. The callback must be of the form:

```
void dxlSortFn(string s1, string s2){
}
```

The sort function must return the following values:

Expression	Returns
<code>s1==s2</code>	0
<code>s1&gt;s2</code>	1
<code>s1&lt;s2</code>	-1

---

If this function is used with an incorrect type DBE, a DXL run-time error occurs.

---

## set(tree view expand)

---

### Declaration

```
void set(DBE treeView, bool expand(DBE, string))
```

### Operation

Attaches a callback to a tree view. The callback fires when an attempt is made to expand a specific branch. The callback must be of the form:

```
void expand(DBE treeView, string branch) {
}
```

The callback function must return the following values:

Meaning	Returns
Allow expansion	true
Refuse expansion	false

If this function is used with an incorrect type DBE, a DXL run-time error occurs.

---

## setFocus

---

### Declaration

```
void setFocus(DBE element)
```

### Operation

Sets keyboard focus to the specified element.

---

## getBuffer(DBE)

---

### Declaration

```
Buffer getBuffer(DBE element)
```

### Operation

Creates a new buffer object and returns it. The returned buffer contains the value of the specified DBE element.

### Example

```
DB exBox = create "DBE example"
DBE stringIn = field(exBox, "String:", "Example", 20)
void doGet(DB exBox) {
    Buffer b = create
```

```

        b = getBuffer(stringIn)
        print b "\n"
    } // doGet
    apply(exBox, "Get", doGet)
    show exBox

```

---

## setFromBuffer(DBE, Buffer)

---

### Declaration

```
void setFromBuffer(DBE element, Buffer b)
```

### Operation

Sets the contents of the specified DBE element from the contents of the specified buffer b.

### Example

```

DB exBox = create "DBE example"
DBE stringIn = field(exBox, "String:", "Example", 20)
Buffer b = create
b = "test setting DBE from buffer"
setFromBuffer(stringIn, b)
show exBox

```

---

## useRTFColour

---

### Declaration

```
void useRTFColour(DBE dbe, bool useRTF)
```

### Operation

If dbe *dbe* is a rich text box or a rich text field, then:

- If *useRTF* is true, the underlying editbox will use the rtf color markup instead of the default color for text in dialog boxes
- If *useRTF* is false, the underlying editbox will use the default system color for text in dialog boxes
- If the dbe *dbe* is not rich text or a rich text field, nothing happens
- If the dbe *dbe* has not been realized, nothing happens

### Example

```

DB test = create("Test text db")
DBE textdbe = richText(test, "test", "initial", 200, 200, false)

```



```

string colourstring =
"{\\rtf1\\ansi\\ansicpg1252\\deff0\\deflang1033{\\fonttbl{\\f0\\fswiss\\fcharse
t0 Arial;}}
{\\colortbl
;\\red255\\green0\\blue0;\\red255\\green0\\blue255;\\red0\\green0\\blue128;}
\\viewkind4\\uc1\\pard\\f0\\fs20 Some\\cf1 text \\cf0 with \\cf2 different\\cf0
\\cf3 colors\\cf0 in it.\\par
}\\par
}"

realize test
useRTFColour(textdbe, true)
set(textdbe, colourstring)
show test

```

---

## Simple elements for dialog boxes

This section defines functions for simple elements such as two-state options, with the exception of buttons, which are defined in “Buttons,” on page 554. More complex elements that allow the user to choose from various options are defined in “Choice dialog box elements,” on page 538.

---

### label

---

#### Declaration

```
DBE label(DB box,
          string label)
```

#### Operation

Creates a label element in dialog box *box*.

#### Example

```
DB infoBox = create "About SimParse"
label(infoBox, "SimParse V2.1")
show infoBox
```

---

## separator(dialog box)

---

### Declaration

```
DBE separator(DB box)
```

### Operation

Places a full width separating line across dialog box *box*.

### Example

This example creates a separator between the input slider and the output field. Dialog boxes normally include a separator, which is automatically created, between the user-defined elements and the standard buttons.

```
DB exBox = create "Use of Separator"
DBE input = slider(exBox, "Input:", 50, 0, 100)
separator exBox
DBE output = field(exBox, "Output:", "", 30)
void calc(DB exBox) {
    int i = get input
    set(output, "Input was " i "")
} // calc
apply(exBox, calc)
show exBox
```

---

## splitter

---

### Declaration

```
DBE splitter(DB box,
             DBE left,
             DBE right,
             int width)
```

### Operation

Places a movable vertical separating line across dialog box *box*. The arguments define the left part of the dialog box, the right part of the dialog box, and the width of the splitter in pixels. This is only supported for DBEs of type `listView` or `treeView`.

### Example

```
// constants
const string SARR_DUMMY[] = {}
// constants
const int TREE_WIDTH = 150
```

```

const int TREE_HEIGHT = 10
const int LIST_WIDTH = 300
const int LIST_HEIGHT = 10
// dxl dialogs
DB dlg = null
// dxl elements
DBE dbeTree, dbeList, dbeSplitter
// create dialog
dlg = create("Test", styleCentered)
// tree
dbeTree = treeView(dlg, 0, TREE_WIDTH,
                  TREE_HEIGHT)
dbeTree->"top"->"form"
dbeTree->"left"->"form"
dbeTree->"bottom"->"form"
dbeTree->"right"->"unattached"
// list
dbeList = listView(dlg, 0, LIST_WIDTH,
                  LIST_HEIGHT, SARR_DUMMY)
dbeList->"top"->"aligned"->dbeTree
dbeList->"left"->"unattached"
dbeList->"bottom"->"form"
dbeList->"right"->"form"
// splitter
dbeSplitter = splitter(dlg, dbeTree, dbeList, 4)
dbeSplitter->"top"->"form"
dbeSplitter->"left"->"unattached"
dbeSplitter->"bottom"->"form"
dbeSplitter->"right"->"unattached"
realize dlg
{
    // information is displayed over a single
    // column
    insertColumn(dbeList, 0, "Name", LIST_WIDTH -
                20, null)
}

```

```
show dlg
```

---

## frame

---

### Declaration

```
DBE frame(DB box,
          string label
          [,int width,
           int height])
```

### Operation

Creates a frame element in *box*, which can contain other elements. The *label* is the title of the frame; width and height specify the size of the frame in pixels. If *width* and *height* are omitted, the frame expands to fit the elements within it.

### Example

This example creates a tab strip and frame, and places the frame inside a tab.

```
const string tabStrings[] = {"A", "B", "C"}
DB box = centered "Example"
DBE theTab
DBE theFrame
void tabCb(DBE xx) {
    int i = get xx
    if (i == 0) {
        show theFrame
    } else {
        hide theFrame
    }
}
theTab = tab(box, tabStrings, 300, 300, tabCb)
// attach all the edges of the tabstrip to the
// form
theTab->"left"->"form"
theTab->"right"->"form"
theTab->"top"->"form"
theTab->"bottom"->"form"
theFrame = frame(box, "A frame", 100, 100)
// place the frame inside the tabstrip
theFrame->"left"->"inside"->theTab
theFrame->"right"->"inside"->theTab
```

```

theFrame->"top"->"inside"->theTab
theFrame->"bottom"->"inside"->theTab
realize box
// ensure widgets are showing for correct tab
tabCb theTab
show box

```

---

## fileName

---

### Declaration

```

DBE fileName(DB box,
             [string label,]
             [,string initFileName
             [,string extension,
              string description
              [,bool readOnly]]])

```

### Operation

Creates a window-wide element inside the specified dialog box for capturing a file name. As in other Rational DOORS windows, there is a field for the file name and a button, **Browse**, to invoke a file selector window. Optionally, the element is called *label*.

When present, the *initFileName* argument provides an initial value, which can be an absolute or relative path.

The fourth and fifth optional arguments allow you to specify a file extension and description, which fill the **File of type** box. Note that not all platforms make use of this additional information.

When the *readOnly* argument is true, it checks the **Open as read-only** box. Note that not all platforms make use of this additional information.

### Example

```

// basic file name
DBE fn = fileName(loader, "input.dat")
// file spec and description added
DBE fn = fileName(load, "input.dat", "*.dat",
                 "Data files")

```

---

## field

---

### Declaration

```
DBE field(DB box,
          string label,
          string initial,
          int width
          [,bool readOnly])
```

### Operation

Creates a single-line text-field element. The parameters define a label, an initial value, the number of characters that are visible in the field, and whether the field is read only (`true` means read only). If the last argument is omitted, the function creates a read-write field.

The width of the resulting element is independent of the default user interface font on the current platform.

### Example

```
DB fieldBox = create "Get Zip"
DBE zip = field(fieldBox, " Zipcode: ", "", 12)
void unzip(DB fieldBox) {
    string zipcode = get zip
    print zipcode
} // unzip
apply(fieldBox, "Lookup", unzip)
show fieldBox
```

---

## richField

---

### Declaration

```
DBE richField(DB box,
              string label,
              string initial,
              int width
              [,bool readOnly])

DBE richField(DB box,
              string label,
              richText(string initial),
              int width)

DBE richField(DB box,
              string label,
              richText(string initial),
              int width,
              bool readOnly)
```

## Operation

Creates a single-line rich text field element.

In the first form, arguments define a label, an initial value, the number of characters in the field, and whether the field is read only (`true` means read only). If the last argument is omitted, the function creates a read-write field.

The second form takes a rich text string for the initial value; it cannot create a read only field.

The third form takes a rich text string for the initial value. If `readOnly` is `true`, the function creates a read only field. If `readOnly` is `false`, the function creates a read-write field.

The width of the resulting element is independent of the default user interface font on the current platform.

## slider

### Declaration

```
DBE slider(DB box,
           string label,
           int initial,
           int min,
           int max)
```

### Operation

Creates a slider element for capturing integers. The arguments passed specify a label, the initial value and the minimum and maximum values on the slider.

Sliders are best used for small ranges such as percentages. For larger numbers, or those without limits, it is better to use a text field and the `intOf` function to convert the string value to an integer.

### Example

```
DB percentBox = create "Your Feedback"
label(percentBox, "How strongly do you agree?")
DBE feelings = slider(percentBox, "Adjust
                    slider:", 50, 0, 100)
DBE output = field(percentBox, "Output:", "", 30,
                  true)
void calc(DB percentBox) {
    int results = get feelings
    print results
    set(output, results "")
} // calc
apply(percentBox, "Commit", calc)
show percentBox
```

---

## checkBox

---

### Declaration

```
DBE {verticalC|c}heckBox(DB box,
                        string label,
                        string choices[ ],
                        int initial)
```

### Operation

Creates a set of check boxes.

Check boxes offers users choices, each of which can independently be either on or off.

The `checkBox` function arranges the check boxes horizontally; the `verticalCheckBox` function arranges them vertically. The options are passed in string array `choices`. The `initial` and returned values are bit maps indicating whether each option is checked. If the first option is checked, bit 0 is 1, if the second is checked bit 1 is 1, and so on.

### Example

```
DB pizzaBox = create "Pizzas"

string toppings[] = {"salami", "funghi",
                    "olives", "anchovies",
                    "frutti di mare",
                    "artichoke"}

int maxToppings = 5

DBE pizzaCheck = checkBox(pizzaBox, "Toppings:",
                          toppings, 5)

bool pizzasOrdered[] = {false, false, false,
                        false, false, false}

void processOrders(DB pizzaBox) {
    int bitmap = get pizzaCheck
    // bit-map of values

    int remain
    int i

    for i in 0:maxToppings do {
        remain = bitmap % 2      // remainder

        if (remain != 0) {
            pizzasOrdered[i] = true
            print toppings[i] ":"
                pizzasOrdered[i] "\n"
        } else {
            pizzasOrdered[i] = false
        }

        bitmap = bitmap / 2     // integer division
    }
}
```



```

    }
} // processOrders
apply(pizzaBox, "Order Pizzas", processOrders)
show pizzaBox

```

## radioBox

### Declaration

```

DBE {verticalR|r}adioBox(DB box,
                        string label,
                        string choices[ ],
                        int initial)

```

### Operation

Creates a set of radio boxes.

Radio boxes offers users choices that are mutually exclusive.

The `radioBox` function arranges the check boxes horizontally; the `verticalRadioBox` function arranges them vertically. The options are passed in string array *choices*. The *initial* and returned values are indexes into that array.

### Example

```

DB dinnerBox = create("Dinner")
string meals[] = {"Pizza", "Pasta", "Quiche",
                 "Burger", "Tachos"}

DBE dinnerRadio = radioBox(dinnerBox, "Main
                           Course: ", meals, 2)

void placeOrder(DB dinnerBox) {
    int i = get dinnerRadio
    string mealStr = meals[i]
    ack "Ordering " mealStr " now!"
} // placeOrder

apply(dinnerBox, "Order", placeOrder)

show dinnerBox

```

## toggle

### Declaration

```

DBE toggle(DB box,
           string label,
           bool initial)

```

## Operation

Creates a toggle button in *box* with the given label and initial value.

## Example

```
DB parseBox = create "Simulator File Parser"
DBE binOpt = toggle(parseBox, "Use binary data",
                    false)

show parseBox
```

## date

### Declaration

```
DBE date(DB date_db, int width, Date init, bool calendar)
```

### Operation

Creates a date/time picker control. *Width* specifies the width in characters of the displayed field. The variable *init* specifies the initial date value displayed by the control. If a null date value is supplied, the current date and time is displayed. If *calendar* is true, a drop-down calendar is made available in the control for selecting dates. Otherwise, up and down buttons in the control allow the user to increment and decrement values in the selected field of the control.

You can type values into the various fields of the control, and use the cursor arrow keys to select fields and increment or decrement values.

The date values are displayed according to Rational DOORS conventions: date/time values are displayed using the user's default short date format for the current user locale, and a 24-hour clock format. Date-only values are displayed using the user's default long date format for the current user locale.

## setLimits

### Declaration

```
void setLimits(DBE date_dbe, Date min, Date max)
void setLimits(DBE date_dbe, AttrType type)
```

### Operation

Sets the minimum and maximum limit values for a date/time picker control. If the current value displayed in the picker lies outside either of the new limits, it is updated to equal that limit. If either one of the supplied values is null, then the relevant *min/max* limit is not changed.

The second form sets the minimum and maximum limit values for a date/time picker control to match the limits defined for the specified attribute type. The current displayed value is updated if necessary to lie within the limit or limits.

---

## getDate

---

### Declaration

```
Date getDate(DBE date_dbe)
```

### Operation

Returns the date value displayed in the specified DBE.

---

## set

---

### Declaration

```
void set(DBE date_dbe, Date value)
void set(DBE date_dbe, string value)
```

### Operation

Updates the DBE to display the specified date value.

The second form of the perm is updated to put the string (interpreted according to the current user locale) into the date DBE. No update occurs if the supplied string is not a valid date string.

---

## get

---

### Declaration

```
string get(DBE date_dbe)
```

### Operation

Returns the displayed string in a date DBE.

---

## getBuffer

---

### Declaration

```
Buffer getBuffer(DBE date_dbe)
```

### Operation

Returns the displayed string from a date DBE as a buffer.

---

## setFromBuffer

---

### Declaration

```
void setFromBuffer(DBE date_dbe, Buffer b) / set(DBE, Buffer)
```

---

## Operation

Updates the DBE to display the date represented by the string in the supplied buffer, interpreted according to the current user locale. The DBE is not updated if the supplied string is not a valid date string.

## Example

The following example uses the perms for the new data DBE element:

```
// DateTime Picker Test: gets and sets date values.
DB db = create "date/time picker test" // The Dialog
Date init = dateAndTime(today) // Initial value in control
label(db, "picker:")
beside db
DBE picker = date(db, 20, init, true) // Define the control

// Callback for toggle...
void showTimeCB(DBE x)
{
    if (get(x))
    {
        set(picker, dateAndTime(getDate picker))
    }
    else
    {
        set(picker, dateOnly(getDate picker))
    }
}

// Toggle the showing of date+time or date-only
DBE showTime = toggle(db, "show time", includesTime(init))
set(showTime, showTimeCB)

// Text field to display values got from the control, and for
// sending to the control.
left db
DBE stringVal = field(db, "string field:", "", 20)
```

```

// Get the current value from the control, as a Date value.
void getDate(DBE x)
{
    Date d = getDate(picker)
    set(stringVal, stringOf(d))
}
button(db, "Get Date", getDate)
beside db

// Get the current value from the control, as a string.
void getString(DBE x)
{
    string s = get(picker)
    set(stringVal, s)
}
button(db, "Get string", getString)

// Get the current value from the control, as a Buffer.
void getDateBuffer(DBE x)
{
    Buffer b = getBuffer(picker)
    set(stringVal, b)
    delete b
}
button(db, "Get Buffer", getDateBuffer)
left db

// Update the control using a Date value
void setDate(DBE x)
{
    string s = get(stringVal)
    Date d = date(s)
    if (null d) warningBox "Not a valid date string!"
    else set(picker, d)
}

```

```

        set(showTime, includesTime(getDate picker))
    }
button(db, "Set Date", setDate)
beside db

// Update the control using a string value
void setString(DBE x)
{
    string s = get(stringVal)
    set(picker,s)
    set(showTime, includesTime(getDate picker))
}
button(db, "Set string", setString)

// Update the control using a Buffer value
void setDateBuffer(DBE x)
{
    Buffer b = getBuffer(stringVal)
    setFromBuffer(picker,b)
    set(showTime, includesTime(getDate picker))
    delete b
}
button(db, "Set Buffer", setDateBuffer)
left db
Date minDate = null
Date maxDate = null

// Set the minimum value accepted by the date/time picker
void setMinVal(DBE x)
{
    string s = get(stringVal)
    minDate = date(s)
    if (null minDate)
    {

```

```

        warningBox "Not a valid date string!"
    }
    else if (!null maxDate && minDate > maxDate)
    {
        warningBox "Minimum date cannot be greater than maximum date."
    }
    else
    {
        setLimits(picker,minDate,maxDate)
    }
}
button(db, "Set Min from field", setMinVal)
beside db

// Set the maximum value accepted by the date/time picker
void setMaxVal(DBE x)
{
    string s = get(stringVal)
    maxDate = date(s)
    if (null maxDate)
    {
        warningBox "Not a valid date string!"
    }
    else if (!null minDate && minDate > maxDate)
    {
        warningBox "Maximum date cannot be less than minimum date."
    }
    else
    {
        setLimits(picker,minDate,maxDate)
    }
}
button(db, "Set Max from field", setMaxVal)
show db

```

---

## Choice dialog box elements

This section defines functions and `for` loops that allow you to create elements that give the user a choice:

- A drop-down selector provides a simple choice.
- A combo box is an editable drop-down selector.
- A tab strip provides a simple choice where other options must be selected after the initial selection.
- Scrollable lists are a powerful mechanism for providing users with a large number of options.

These dialog box elements are all of type DBE.

---

### choice

---

#### Declaration

```
DBE choice(DB box,
           string label,
           string choices[ ],
           [int noOfChoices,]
           int initial
           [,int width,
           bool canEdit])
```

#### Operation

Creates a drop-down selector. This shows only the current value until the user clicks in it, when the whole range is displayed. The *initial* argument specifies which value is selected by default, counting from 0.

The string array *choices* must have been declared at a fixed size, with each element containing a string. The optional *noOfChoices* argument specifies the number of elements of the *choices* array that contain real choices.

The optional *width* argument specifies the number of characters in the choice box. When used, this argument must be followed by a boolean value to indicate whether the choice can be edited by the user. If *canEdit* is `true`, the choice box is editable (a combo box). If *width* is 0, -1, or omitted, the standard width is used.

The width of the resulting element is independent of the default user interface font on the current platform. The width will be consistent with the legacy behavior on Western platforms with regard to the resultant width calculated from the specified number of characters.

#### Example

```
DB reqBox = create "Edit Requirement"
string importance[] = {"Vital", "Useful",
                     "Convenient", "Useless"}
DBE reqImport = choice(reqBox, "Importance: ",
                      importance, 2)
```



```

void accept(DB reqBox) {
    int i = get reqImport
    print importance[i]
} // accept
ok(reqBox, "Accept", accept)
show reqBox

```

---

## tab

---

### Declaration

```

DBE tab(DB box,
        string choices[ ]
        [,int noOfChoices]
        [,int width,
         int height],
        void (DBE theTab))

```

### Operation

Creates a tab strip. This function behaves much like the list function.

The string array *choices* must have been declared at a fixed size, with each element containing a string. The optional *noOfChoices* argument specifies the number of elements of the *choices* array that contain real choices.

The optional *width* and *height* arguments specify the initial size of the tab strip in pixels. If *width* and *height* are not specified, the size is controlled by the elements the tab strip contains, or from the form if the tab strip is connected to it. If the right edge of a tab strip is to remain unattached, you must specify a size. A tab strip with an initial size can stretch if placement constraints are incompatible with the size specified.

You can place other dialog box elements inside a tab strip using the placement keyword *inside*, but you should not put an element with no innate size (like a list box) inside a tab with no innate size. For further information on tab strip placement, see “Attachment placement,” on page 599.

The callback function must identify which tab has been selected.

### Example

```

DB box = create "Test"
void tabSelected(DBE theTab){
    int i = get theTab
}
string items[] = {"A", "B", "C"}
DBE theTab = tab(box, items, 300, 400,
                tabSelected)
theTab->"top"->"form"
theTab->"left"->"form"
theTab->"bottom"->"form"

```

```
theTab->"right"->"unattached"
```

---

## list

---

### Declaration

```
DBE list(DB box,
         string label,
         [int width,]
         int visible,
         string values[ ]
         [,int noOfValues])
```

### Operation

Creates a list element containing the given values, from which the user can choose at most one item. If there are many or a variable number of options, a list is better than a choice as it does not attempt to display more than the number of items passed in the *visible* argument. If the *width* argument is present, the element is created at the specified size in pixels. Otherwise, the list is created to use the full width of the dialog box.

You can supply either a complete array of strings, such as a constant array, or a partially filled array, with the number of items supplied in the *noOfValues* argument. You can create a list with initially no entries by setting *noOfValues* to 0, although you must still supply a valid string array.

Note that there is no initial selection; to do this, use the `set (value or selection)` function. You can also define callbacks for lists.

### Example

```
DB coffeeBox = create "Coffees"
string coffees[] = {"Mocha", "Sumatra Blue",
                  "Jamaica Mountain",
                  "Mysore", "Kenya", "Java"}
DBE coffeeList = list(coffeeBox, "Choose one
of:", 5, coffees)
void getCoffees(DBE coffeeList) {
    int i = get coffeeList
    if (i == 0) ack "Mmm, Mocha..."
    if (i == 5) ack "Watch out for trademark
violations"
} // getCoffees
// run callback directly upon list selection
set(coffeeList, getCoffees)
show coffeeBox
```

---

## multiList

---

### Declaration

```
DBE multiList(DB box,
              string label,
              [int width,]
              int visible,
              string values[ ]
              [,int noOfValues])
```

### Operation

Creates a list element containing the given values, from which the user can choose one or more items. In all other respects this function is exactly the same as the `list` function.

### Example

```
DB attrShow = create "Attributes"
string attrNames[100]
int noOfAttrs = 0
string an
if (null current Module) {
    ack "Please run this function from a module"
    halt
}
for an in current Module do
    attrNames[noOfAttrs++] = an
DBE attrList = multiList(attrShow, "Attributes:",
                        5, attrNames, noOfAttrs)
void printAttrs(DB box) {
    string attrName
    for attrName in attrList do {
        print attrName " = " ((current
                               Object).attrName) "\n"
    }
} // printAttrs
apply(attrShow, "Print", printAttrs)
void clearSelection(DB box) {
    int i
    for i in 0:noOfAttrs do
        set(attrList, i, false)
} // clearSelection
apply(attrShow, "Clear", clearSelection)
```

```
show attrShow
```

---

## selectedElems

---

### Declaration

```
int selectedElems (DBE listView)
```

### Operation

Returns the number of elements currently selected in the specified list view.

Typically this is either 0, 1 or a positive integer (if the list view was created using the `listViewOptionMultiselect` style).

If the DBE is not a list view, a run-time error occurs.

---

## for value in list (selected items)

---

### Syntax

```
for s in list do {
  ...
}
```

where:

*s* is a string variable

*list* is a multilist of type DBE

### Operation

Assigns the string *s* to be each successive selected item in a multilist, *list*.

### Example

```
string at
for at in attrList do print at " is selected\n"
```

---

## for position in list (selected items)

---

### Syntax

```
for i in list do {
  ...
}
```

where:

*i* is an integer variable  
*list* is a multilist of type DBE

## Operation

Assigns the integer *i* to be the index of each successive selected item in a multilist, *list*.

## Example

```
int totalWeight = 0
int index
for index in components do
    totalWeight += compWeights[index]
```

---

# View elements

This section defines functions and `for` loops that allow you to create list views and tree views in your dialog boxes.

---

## Drag-and-drop

Drag-and-drop operations are possible in list views and tree views, provided a callback function is specified when the list view or tree view is created. The callback takes the form:

```
void callback(DropEvent dropEvent)
```

The `DropEvent` structure is unique to the source of the drag; it exists for only as long as the dialog box element being dragged.

Properties are defined for use with the `.` (dot) operator and `DropEvent` structure to extract information about drop events, as shown in the following syntax:

```
dropEvent.property
```

where:

*dropEvent* is a variable of type `DropEvent`  
*property* is one of the drag-and-drop properties

The following tables list the properties and the information they extract:

String property	Extracts
<code>sourcePath</code>	The path of the source item of a drag operation; this is only valid if <code>sourceIsListView</code> is <code>true</code> , otherwise, it is <code>null</code> .

String property	Extracts
<code>targetPath</code>	The path of the target item of a drag operation; this is only valid if <code>targetIsListView</code> is <code>true</code> , otherwise, it is <code>null</code> .

Boolean property	Extracts
<code>sourceIsTreeView</code>	Whether the source of the drag is a tree view.
<code>sourceIsListView</code>	Whether the source of the drag is a list view.
<code>targetIsTreeView</code>	Whether the target of the drag is a tree view.
<code>targetIsListView</code>	Whether the target of the drag is a list view.

Integer property	Extracts
<code>sourceIndex</code>	The index of the source item of a drag operation; this is only valid if <code>sourceIsListView</code> is <code>true</code> , otherwise, it is <code>-1</code> .
<code>targetIndex</code>	The index of the target item of a drag operation; this is only valid if <code>targetIsListView</code> is <code>true</code> , otherwise, it is <code>-1</code> .

DBE property	Extracts
<code>source</code>	The source dialog box element of the drag operation; this is always the element for which the callback was defined.
<code>target</code>	The target dialog box element of the drag operation.

## Example

```
DropEvent de
bool b = de.targetIsTreeView
DBE testList = de.source
```

---

## listView

---

### Declaration

```
DBE listView(DB box
             [,void callback(DropEvent event),
              int options,
              int width,
              int lines,
              string items[ ]
              [,int noOfItems])
```

### Operation

Creates a list view having the specified width in pixels and with the specified number of lines.

The optional callback function enables the list view to participate in drag-and-drop events. When this list view is the source of a drop operation, the callback fires and the `DropEvent` structure can be queried. For further information, see “Drag-and-drop,” on page 543. If the callback function is not supplied, the user cannot use drag-and-drop in the list view.

The string array *items* must have been declared at a fixed size, with each element containing a string. The optional *noOfItems* argument specifies the number of elements of the *items* array that contain real choices.

The argument *options* controls whether the list view has check boxes. The value can be one of the following:

<code>listViewOptionCheckboxes</code>	provides check boxes
<code>listViewOptionMultiselect</code>	makes it possible to select more than one item*
<code>0</code>	no check boxes or multi-select capability
<code>listViewOptionCheckboxes   listViewOptionMultiselect</code>	provides check boxes and multi-select capability
<code>listViewOptionSortText</code>	for use with the <code>setSortColumn</code> perm

\*Beginning in Rational DOORS version 9.6.1.7, you can use Ctrl+A keys to select all items in a multiselect listView.

---

## deleteColumn

---

### Declaration

```
string deleteColumn(DBE listView,
                   int columnIndex)
```

### Operation

Deletes from *listView* the column identified by *columnIndex* counting from 0. This works only for list views.

---

## insertColumn(list view)

---

### Declaration

```
void insertColumn(DBE listView,
                 int columnIndex,
                 string title,
                 int width,
                 Icon icon)
```

### Operation

Inserts a column in *listView* after the column identified by *columnIndex* counting from 0. The new column has title *title*, width in pixels of *width*, and icon *icon*. To insert a column without an icon use the value `iconNone`. For other valid icon values, see “Icons,” on page 481.

This works only for list views.

---

## getColumnValue

---

### Declaration

```
string getColumnValue(DBE listView,
                    int row,
                    int column)
```

### Operation

Returns the value of the item or subitem identified by *row* in *column*. Both *row* and *column* count from 0. This works only for list views.

### Example

This example returns the 34th row of the first column in list view `main`.

```
string s = getColumnValue(main, 33, 0)
```

---

## getCheck

---

### Declaration

```
bool getCheck(DBE listView,
             int index)
```

### Operation

Returns `true` if the check box identified by *index* is selected; otherwise, returns `false`. This works only for list views.



---

## setCheck

---

### Declaration

```
void setCheck(DBE listView,  
             int index,  
             bool checked)
```

### Operation

Selects or clears the check box identified by *index* according to the value of *checked*. This works only for list views.

---

## getSortColumn

---

### Declaration

```
int getSortColumn(DBE listView)
```

### Operation

Returns the column in *listView* that is being sorted. This works only for list views.

---

## setSortColumn

---

### Declaration

```
void setSortColumn(DBE listView,  
                  int columnIndex)
```

### Operation

Sets the column to be sorted to the column specified by *columnIndex*. This works only for list views.

---

## treeView

---

### Declaration

```
DBE treeView(DB box  
            [,void callback(DropEvent event)],  
            int options,  
            int width,  
            int visible)
```

### Operation

Creates a tree view having the specified width in pixels and with the specified number of visible items (which controls the height of the tree view).

The optional callback function enables the list view to participate in drag-and-drop events. When this list view is the source of a drop operation, the callback fires and the `DropEvent` structure can be queried. For further information, see “Drag-and-drop,” on page 543. If the callback function is not supplied, the user cannot use drag-and-drop in the list view.

The `options` argument can be `0` or `treeViewOptionSorted`, which sorts the tree view.

---

## exists(tree view)

---

### Declaration

```
bool exists(DBE treeView,
            string fullPath)
```

### Operation

Returns `true` if a `fullPath` is the full path name of a tree view; otherwise, returns `false`.

---

## layoutDXL

---

### Declaration

```
void layoutDXL(DBE treeView)
```

### Operation

Loads the specified tree view with a hierarchy of DXL files, which can be used for column layout DXL.

If the DBE is not a tree view, a run-time error occurs.

---

## attributeDXL

---

### Declaration

```
void attributeDXL(DBE treeView)
```

### Operation

Loads the specified tree view with a hierarchy of DXL files, which can be used for DXL attribute.

If the DBE is not a tree view, a run-time error occurs.

---

## getDXLFileHelp, getDXLFileName

---

### Declaration

```
string getDXLFileHelp(DBE treeView)
string getDXLFileName(DBE treeView)
```

## Operation

These functions assume that the specified tree view contains a hierarchy of DXL files loaded using the `layoutDXL` function (similar to the contents of the DXL Browser dialog box). If one of the files is selected, and you call either of these functions, typically from a button callback, they behave as described here.

The first function returns the help text associated with the selected DXL file.

The second function returns the name of the selected file.

If the dialog box element is not a tree view, a run-time error occurs.

## templates

### Declaration

```
void templates(DBE treeView)
```

### Operation

Populates the specified tree view with a hierarchy of available templates (DXL files) that are in the `lib\dxl\standard\ template` directory.

## getTemplateFileName

### Declaration

```
string getTemplateFileName(DBE treeView)
```

### Operation

Assumes that the specified tree view contains a hierarchy of available templates previously loaded using the `templates` function.

When a template is selected on a user's PC or workstation, returns the full path of the selected file. Otherwise, returns a null string.

### Example

```
// prevent dxl timeout dialog
#pragma runLim, 0
// constants
const int INITIAL_TREE_WIDTH = 500
const int INITIAL_TREE_HEIGHT = 20
// dxl dialog
DB dlg = null
// dxl elements
DBE dbeTree, dbeLabel
// function
```

```

void fnTreeSelect(DBE xx)
{
    string sTemplate = getTemplateFileName(xx)

    // only relevant if actual template was
    // selected

    if (sTemplate != null)
    {
        // inform user
        infoBox(dlg, sTemplate)
    }
}

dlg = create(dbExplorer, "Templates", styleCentered | styleFixed)
// label
dbeLabel = label(dlg, "Please select an item from
                  the tree...")

dbeLabel->"top"->"form"
dbeLabel->"left"->"form"
dbeLabel->"right"->"unattached"
dbeLabel->"bottom"->"unattached"

// tree view
dbeTree = treeView(dlg, 0, INITIAL_TREE_WIDTH, INITIAL_TREE_HEIGHT)
dbeTree->"top"->"spaced"->dbeLabel
dbeTree->"left"->"form"
dbeTree->"right"->"form"
dbeTree->"bottom"->"form"

realize dlg
{
    // callbacks
    set(dbeTree, fnTreeSelect)

    // load templates into tree view
    templates(dbeTree)
}

block dlg

```

---

## for value in list view (selected items)

---

### Syntax

```
for s in listView do {  
  ...  
}
```

where:

*s* is a string variable  
*listView* is a list view of type DBE

### Operation

Assigns the string *s* to be each successive selected item in a list view.

---

## for position in list view (selected items)

---

### Syntax

```
for i in listView do {  
  ...  
}
```

where:

*i* is an integer variable  
*listView* is a list view of type DBE

### Operation

Assigns the integer *i* to be the index of each successive selected item in a list view, *listView*.

---

## Text editor elements

This section defines text editor functions, which allow you to create a full function text editing panel in your dialog box. These have the same functions as all Rational DOORS text panels, including pop-up menu support for loading and saving files.

---

## text(box)

---

### Declaration

```
DBE text(DB box,
         string label,
         string initial,
         [int width,]
         int height,
         bool readOnly)
```

### Operation

Creates a multi-line text element in the dialog box *box*. The arguments define a label, an initial value, the width of the text box in pixels, the height of the text box in pixels, and whether the text box is read only (`true` means the user cannot modify the contents of the text box). If *width* is omitted, the box takes the full width of the window.

### Example

```
void sendRID(DB RIDbox) {
    // process RID in some way
} // sendRID

DB RIDbox = create "Review Item Discrepancy"
DBE response = text(RIDbox, "Your response:", "",
                   200, false)

apply(RIDbox, sendRID)
show RIDbox
```

---

## richText(box)

---

### Declaration

```
DBE richText(DB box,
             string label,
             {string
              initial|richText(string initial)},
             int width,
             [int height,]
             bool readOnly)
```

### Operation

Creates a multi-line rich text element in the dialog box *box*. The arguments define a label, an initial value (which can be rich text), the width of the text box in pixels, the height of the text box in pixels, and whether the text box is read only (`true` means the user cannot modify the contents of the text box). If *height* is omitted, the box takes the full height of the window.

If the blinking cursor appears at the end of the text in the box when it is displayed, append "" to the end of the rich text string before passing it to the perm.

---

## home

---

### Declaration

```
void home(DBE textElem)
```

### Operation

Causes the cursor to go to the first character in *textElem*.

### Example

```
home messageArea
```

---

## modified

---

### Declaration

```
bool modified(DBE textElem)
```

### Operation

Returns `true` if the text in *textElem* has been modified since it was last set.

### Example

```
if (modified errorLog && confirm
    "Save error log changes?")
    saveErrorLog
```

---

## get(selected text)

---

### Declaration

```
bool get(DBE textElem,
         int &first,
         int &last)
```

### Operation

Returns the selection indices for a text element. If there is a selection, the function returns `true`, and sets the *first* and *last* arguments to the zero-based indices of the first character and the character immediately after the last one selected.

If there is no selection, the function returns `false`.

### Example

```
DB splitBox = create "Text splitter"
DBE objTextElem = text(splitBox, "Object text:",
                      "1234567890", 200, false)
```

```

void getSelection(DB splitBox) {
    int first, last

    if (get(objTextElem, first, last)) {
        string ot = get objTextElem
        string selection = ot[first:last-1]
        print "You selected:\n" selection "\n"
    } else {
        print "No selection\n"
    }
} // getSelection
apply(splitBox, "Get selection", getSelection)
show splitBox

```

---

## Buttons

This section defines functions that allow you to create buttons on dialog boxes. Rational DOORS dialog boxes provide two kinds of buttons: those across the bottom of the dialog box, and those that appear in the dialog box area itself.

---

### ok

---

#### Declaration

```

DBE ok(DB box,
       [string label,]
       void callback(DB))

```

#### Operation

Adds a button to the row of standard buttons on the dialog box, and associates it with the given callback function. If the *label* argument is passed, the button has that label; otherwise it has the standard label **OK**.

When the user clicks the button, the function is called with the parent dialog box as the argument, and the dialog box is removed from the screen.

#### Example

```

void writeout(DB box) {
    // user code here
} // writeout

ok(fileOpBox, "Write", writeout)

```



---

## apply

---

### Declaration

```
DBE apply(DB box,
          [string label,]
          void callback(DB))
```

### Operation

Adds a button to the row of standard buttons on the dialog box, and associates it with the given callback function. If the *label* argument is passed, the button has that label; otherwise it has the standard label `Apply`.

When the user clicks the button, the function is called with the parent dialog box as the argument. The dialog box remains on the screen, enabling this or other buttons to be clicked.

### Example

```
void sumAttrs(DB box) {
    // user code here
}

apply(analysisBox, "Calculate", sumAttrs)
```

---

## close

---

### Declaration

```
void close(DB box,
           bool includeButton,
           void closeAction(DB))
```

### Operation

Normally a **Close** button is added to the row of standard buttons on a dialog box. The normal action of the **Close** button is to close the dialog box.

If the *includeButton* argument is `false`, the **Close** button is omitted from the dialog box, although the user can still close the window via the window manager or system menu. This enables you to supply a close-action button that has an alternative label.

Because closing the dialog box might not always be desirable behavior, this function enables you to replace the standard close action with a callback function. When a callback function is supplied, windows are **not** automatically closed; the callback must explicitly hide the dialog box (see the `hide(dialog box)` function).

### Example

```
DB exBox = create "Example"

DBE tp = text(exBox, "Text", "Type in here", 100,
             false)

DBE check = toggle(exBox, "Check before closing",
                  true)
```

```

void checkText(DB exBox) {
    if (modified(tp) && !confirm("Text modified,
        really close?"))
        return
    hide exBox
} // checkText
ok(exBox, "Cancel", checkText)
close(exBox, false, checkText)
show exBox

```

---

## button

---

### Declaration

```

DBE button(DB box, string label, void callback(DBE)           [,bool
variableSize|int style])

DBE button(DB box, string label, void callback [, bool variableSize | int style
[, int width]] )

```

### Operation

Creates a button in the specified dialog box. The *callback* function fires whenever the user clicks on the button.

The button can have either a label or an arrow symbol defined by one of the following constants in “ok, apply, button(arrows),” on page 557.

The optional fourth argument enables you to specify the size or style of the button.

If *variableSize* is *false*, the button is 50 pixels wide by 13 pixels high. If *variableSize* is missing or *true*, the button size depends on the label.

The possible values for *style* are: *styleIsDefault*, *styleIsCloseBtn*, *styleStandardSize*, or any OR combination of these values.

The second variant has an optional *width* argument that enables the user to specify the width of the button, in pixels. (As a guide, *standardSize* buttons are 50 pixels wide.) This argument has no effect if the *variableSize* argument is specified as *false*, or if the *style* argument is specified and includes the *standardSize* option.

### Example

```

DB resultsBox = create "Summary Results Display"
DBE caption
void repaint(DBE canv) {
    background(canv, colorLightBlue)
    color(canv, colorMaroon)
    string cap = get caption
    draw(canv, 100, 50, cap)
} // repaint

```

```

DBE canv = canvas(resultsBox, 400, 100, repaint)
caption = field(resultsBox, "Caption:",
                "Callbacks will plot data", 20)

beside resultsBox
void trendPlot(DBE calledfrom) {
    // user code here
    repaint canv
} // trendPlot

DBE trends = button(resultsBox, "Show trends", trendPlot)

show resultsBox

```

---

## ok, apply, button(arrows)

---

Both standard and dialog-area buttons can be created with an arrow instead of a text label. To do this, replace the string label with one of the following constants:

```

topLeftArrow
upArrow
topRightArrow
leftArrow
allWaysArrow
rightArrow
bottomLeftArrow
downArrow
bottomRightArrow
leftRightArrow
upDownArrow

```

### Example

```

DB arrowBox = create "Arrow Demo"
void doNothing(DBE x) {}
void doNothing(DB x) {}
DBE tl = button(arrowBox, topLeftArrow,
               doNothing)

beside arrowBox
DBE up = button(arrowBox, upArrow, doNothing)
DBE tr = button(arrowBox, topRightArrow,
               doNothing)

```

```

leftAligned arrowBox
DBE l = button(arrowBox, leftArrow, doNothing)
beside arrowBox
DBE all = button(arrowBox, allWaysArrow,
                doNothing)
DBE r = button(arrowBox, rightArrow, doNothing)
leftAligned arrowBox
DBE bl = button(arrowBox, bottomLeftArrow,
               doNothing)
beside arrowBox
DBE down = button(arrowBox, downArrow, doNothing)
DBE br = button(arrowBox, bottomRightArrow,
               doNothing)
leftAligned arrowBox
apply(arrowBox, leftRightArrow, doNothing)
apply(arrowBox, upDownArrow, doNothing)
show arrowBox

```

---

## Canvases

This section defines functions for canvases, which allow DXL programs to draw graphics, such as charts and diagrams, in dialog boxes.

Any graphics layout DXL should always specify all co-ordinates in drawing units (du), for example:

```
rectangle(myCanv, 10 du, 10 du, 20 du, 20 du)
```

Otherwise the graphics do not print properly.

---

## Keyboard event constants

### Declaration

```

const char keyInsert
const char keyDelete
const char keyHome
const char keyEnd
const char keyPageUp
const char keyPageDown

```

```

const char keyUp
const char keyDown
const char keyLeft
const char keyRight
const char keyHelp
const char keyF1
const char keyF2
const char keyF3
const char keyF4
const char keyF5
const char keyF6
const char keyF7
const char keyF8
const char keyF9
const char keyF10
const char keyF11
const char keyF12

```

## Operation

These are character constants that represent keyboard presses for invisible characters. They are returned by callbacks defined using `set`.

## canvas

### Declaration

```

DBE canvas(DB box,
           int width,
           int height,
           void repaint(DBE art))

```

### Operation

Creates a drawing surface, which can be used for graphical output with the DXL Graphics Library functions.

Graphics must only be directed to the canvas from the callback function, `repaint`, which you must define, otherwise they are lost at the next repainting. The function is called back when the window appears on the screen, when it is de-iconified, or when an overlapping window is moved.

To add a mouse or key callback to a canvas, use the `set (select)` function.

### Example

```

DB artBox = create "Try resizing this window"

```

```

void doDrawing(DBE art){
    // repaint callback function
    int i, x, y, w, h
    int cw = width art
    int ch = height art

    for i in 0 : 15 do {
        color(art, i)
        x = random cw // size graphics to canvas
        y = random ch
        w = (cw - x) / 2
        h = (ch - y) / 2
        rectangle(art, x, y, w, h)
    }
}
DBE art = canvas(artBox, 400, 300, doDrawing)
show artBox

```

---

## background

---

### Declaration

```

void background(DBE canvas,
                int colorNo)

```

### Operation

Colors the whole of the canvas with the given color. For information on valid color numbers, see “Logical colors,” on page 589. This function destroys any existing drawing, and is equivalent to drawing a rectangle the size of the canvas. This function is recommended if you wish to color the whole canvas or erase the current image.

### Example

```

DB graphBox = create "Graphics"
void repaint(DBE graph) {
    background(graph,
                logicalMediumIndicatorColor)
    // draw picture here
} // repaint
DBE graph = canvas(graphBox, 250, 75, repaint)
show graphBox

```

---

## realBackground

---

### Declaration

```

void realBackground(DBE canvas,
                    int colorNo)

```

## Operation

Colors the whole of the canvas with the given color. For information on valid color numbers, see “Real colors,” on page 591. This function destroys any existing drawing, and is equivalent to drawing a rectangle the size of the canvas. This function is recommended if you wish to color the whole canvas or erase the current image.

## Example

```
DB colorBox = create "To demonstrate the colors"
void doDrawing(DBE colorCanvas) {
    // repaint callback function
    // background(art, logicalPageBackgroundColor)
    realBackground(colorCanvas, realColor_Black)
    color(colorCanvas, logicalPageBackgroundColor)
    draw(colorCanvas, 15, 15,
        "logicalPageBackgroundColor")
    realColor(colorCanvas, realColor_Green)
    draw(colorCanvas, 15, 45, "Red")
    realColor(colorCanvas, realColor_Magenta)
    draw(colorCanvas, 15, 60, "Magenta")
}
DBE colorCanvas = canvas(colorBox, 400, 300, doDrawing)
show colorBox    // draw picture here
```

---

## color

---

### Declaration

```
void colo[u]r(DBE canvas,
              int colorNo)
```

### Operation

Sets the drawing color for the *canvas* to be the given *colorNo*. For information on valid color numbers, see “Logical colors,” on page 589.

### Example

```
color(board, logicalDataTextColor)
```

---

## realColor

---

### Declaration

```
void realColo[u]r(DBE canvas,
                  int realColor)
```

## Operation

Sets the drawing color for the canvas to be the given *realColor*. For information on valid color numbers, see “Real colors,” on page 591.

## Example

See the example for the `realBackground` function.

## font

### Declaration

```
void font(DBE canvas,
          int level,
          int mode)
```

### Operation

Sets the font for drawing strings on the canvas. The font is specified by two logical values corresponding to those in the Font Options window. The *level* argument is in the range 1 to 9 to represent the level in the tree at which a node appears. Essentially, this argument controls the size; level 1 is the top level of heading and typically appears in a large typeface. The *mode* argument controls which font is used: 0 sets body font, 1 sets heading font, and 2 sets graphics font. You can also use the constants `HeadingsFont`, `TextFont`, and `GraphicsFont`.

**Note:** The actual font size and typeface depend on the user’s settings.

### Example

```
DB graphBox = create "Graphics"
void repaint(DBE graph) {
    background(graph, logicalPageBackgroundColor)
    color(graph, logicalDataTextColor)
    int x = 10
    int fsize

    for fsize in 1:9 do {
        font(graph, fsize, 0)
        draw(graph, x, 20, fsize "")
        font(graph, fsize, 1)
        draw(graph, x, 60, fsize "")
        font(graph, fsize, 2)
        draw(graph, x, 90, fsize "")
        x += 20
    }
} // repaint
DBE graph = canvas(graphBox, 300, 100, repaint)
show graphBox
```



---

## height

---

### Declaration

```
int height(DBE canvas
           [,string s])
```

### Operation

With a single argument, this returns the height of *canvas*. This function must be used in repaint functions to obtain the size of the area into which to draw, as this might change.

When the second argument is passed, the function returns the height of the space required to render the string *s* in the current font.

### Example

This example obtains the height of the canvas:

```
int h = height board
```

---

## width

---

### Declaration

```
int width(DBE canvas
          [,string s])
```

### Operation

With a single argument, this returns the width of a *canvas* element. This function must be used in repaint functions to obtain the size of the area into which to draw, as this might change.

When the second argument is passed, the function returns the width of the space required to render the string *s* in the current font.

### Example

This example obtains the width of the canvas:

```
int w = width board
```

This example obtains the height and width of the string variable *message*:

```
DB graphBox = create "Graphics"
void repaint(DBE graph) {
    background(graph,
               logicalMediumIndicatorColor)
    color(graph, logicalHighIndicatorColor)

    int w = width graph
    int h = height graph
    string message = w " by " h ""
    int tw = width(graph, message)
```

```

    int th = height(graph, message)
    int x = (w - tw)/2
    int y = (h - th)/2
    draw(graph, x, y, message)
} // repaint

DBE graph = canvas(graphBox, 250, 150, repaint)
show graphBox

```

## rectangle

### Declaration

```

void rectangle(DBE canvas,
              int x,
              int y,
              int w,
              int h)

```

### Operation

Draws a rectangle filled with the current color at position  $(x,y)$ , width  $w$ , height  $h$  on canvas. The co-ordinate system has its origin at the top left.

### Example

```

DB graphBox = create "Graphics"
void repaint(DBE graph) {
    background(graph,
               logicalMediumIndicatorColor)
    color(graph, logicalHighIndicatorColor)
    rectangle(graph, 50, 50, 150, 50)
} // repaint

DBE graph = canvas(graphBox, 250, 150, repaint)
show graphBox

```

## box

### Declaration

```

void box(DBE canvas,
         int x,
         int y,
         int w,
         int h)

```

## Operation

Draws an outline rectangle with the current color at position  $(x, y)$ , width  $w$ , height  $h$  on canvas. The co-ordinate system has its origin at the top left.

## Example

```
DB graphBox = create "Graphics"
void repaint(DBE graph) {
    background(graph,
        logicalMediumIndicatorColor)
    color(graph, logicalHighIndicatorColor)
    box(graph, 50, 50, 150, 50)
} // repaint
DBE graph = canvas(graphBox, 250, 150, repaint)
show graphBox
```

## line

### Declaration

```
void line(DBE canvas,
    int x1,
    int y1,
    int x2,
    int y2)
```

### Operation

Draws a line from  $(x1,y1)$  to  $(x2,y2)$  in the current color. The co-ordinate system has its origin is at top left.

### Example

```
DB graphBox = create "Graphics"
void repaint(DBE graph) {
    background(graph,
        logicalMediumIndicatorColor)
    color(graph, logicalHighIndicatorColor)
    line(graph, 0, 0, width graph, height graph)
} // repaint
DBE graph = canvas(graphBox, 250, 150, repaint)
show graphBox
```

---

## ellipse

---

### Declaration

```
void ellipse(DBE canvas,
            int x,
            int y,
            int w,
            int h)
```

### Operation

Draws an ellipse filled with the current color within the bounding box specified by position  $(x, y)$ , width  $w$ , height  $h$  on *canvas*. The co-ordinate system has its origin at the top left. If  $w$  and  $h$  are the same, this draws a circle.

### Example

```
DB graphBox = create "Graphics"
void repaint(DBE graph) {
    background(graph,
               logicalMediumIndicatorColor)
    color(graph, logicalHighIndicatorColor)
    ellipse(graph, 0, 0, width graph, height
            graph)
} // repaint
DBE graph = canvas(graphBox, 250, 150, repaint)
show graphBox
```

---

## draw

---

### Declaration

```
void draw(DBE canvas,
          int x,
          int y,
          string s)
```

### Operation

Draws the string  $s$  at position  $(x,y)$ , in the current color with the current font. The co-ordinate system has its origin at top left. The vertical position of the text is at the baseline of the font, so the co-ordinates must be the position for the bottom of most characters. Characters with a descender, such as  $g$ , use height above and below the baseline.

### Example

```
DB graphBox = create "Graphics"
void repaint(DBE graph) {
```

```

background(graph,
    logicalMediumIndicatorColor)

color(graph, logicalHighIndicatorColor)

string message = (width graph) " by " (height
    graph) ""

draw(graph, 10, 20, message)
} // repaint
DBE graph = canvas(graphBox, 250, 150, repaint)
show graphBox

```

---

## drawAngle

---

### Declaration

```

void drawAngle(DBE canvas,
    int x,
    int y,
    string s
    real angle)

```

### Operation

Draws the string *s* rotated counter-clockwise by the given angle (in degrees). The rotation is centered around the baseline of the font, at the start of the string.

### Example

```

string message = "Hello world"
real angle
DB graphBox = create "drawAngle test"
void repaint (DBE graph) {
    background(graph,
        logicalMediumIndicatorColor)

    color(graph, logicalHighIndicatorColor)

    font(graph, 1, 1)

    draw(graph, 0, 25, message)

    for (angle = 0.0; angle < 360.0; angle +=
        360.0 / 8.0)

        drawAngle(graph, 130, 125, message,
            angle)
}
DBE graph = canvas(graphBox, 300, 250, repaint)
show graphBox

```

---

## polarLine

---

### Declaration

```
void polarLine(DBE myCanvas,
               int x,
               int y,
               int lineLength,
               int lineAngle)
```

### Operation

Draws a line on the specified canvas from the co-ordinates ( $x$ ,  $y$ ), with a length of *lineLength* at an angle of *lineAngle* degrees to the horizontal. The horizontal starts at the 3 o'clock position, and the angle increases in a clockwise direction.

### Example

```
int offset = 0
void doDrawing(DBE myCanvas) {
    int i = 0
    ellipse(myCanvas, 50, 50, 200, 200)
    for (i = 0; i < 360; i += 20) {
        polarLine(myCanvas, 150, 150, 100, i +
                  offset)
    }
    offset++
    if (offset >= 20) offset = 0
}
DB myWindow = create "Example"
DBE myCanvas = canvas(myWindow, 300, 300, doDrawing)
show myWindow
```

---

## polygon

---

### Declaration

```
void polygon(DBE myCanvas,
             int coordArray[ ])
```

### Operation

Draws a polygon on the specified canvas using successive co-ordinates held in the specified array.

## Example

```
void doDrawing(DBE myCanvas) {
    int count = 6
    int coords[8]

    background(myCanvas,
               logicalPageBackgroundColor)

    color(myCanvas, logicalDataTextColor)
    coords[0] = 20
    coords[1] = 20
    coords[2] = 100
    coords[3] = 30
    coords[4] = 200
    coords[5] = 100
    coords[6] = 80
    coords[7] = 150
    polygon(myCanvas, coords)
}

DB myWindow = create "Example"
DBE myCanvas = canvas(myWindow, 300, 300,
                     doDrawing)

show myWindow
```

---

## bitmap

---

### Declaration

```
void bitmap(DBE myCanvas,
            string fileName,
            int x,
            int y)
```

### Operation

Draws the bitmap stored in the specified file, at co-ordinates (x,y) on the specified canvas. This is functionally equivalent to calling `loadBitmap`, `drawBitmap` and `destroyBitmap`.

---

## loadBitmap

---

### Declaration

```
Bitmap loadBitmap(DBE myCanvas,
                 string fileName,
                 bool colorMap,
                 int& w,
                 int& h)
```

## Operation

Loads and caches, for the canvas *myCanvas*, the bitmap stored in file *fileName*.

If *colorMap* is true a private color map is used; otherwise, the system color map is used.

Returns in *w* and *h* the width and height of the bitmap.

Returns the handle of the bitmap.

## drawBitmap

### Declaration

```
void drawBitmap(DBE myCanvas,
               Bitmap myBitMap,
               int x,
               int y)
```

### Operation

Draws the specified bitmap on the specified canvas at co-ordinates (*x,y*).

## destroyBitmap

### Declaration

```
void destroyBitmap(DBE myCanvas,
                  Bitmap bitMapHandle)
```

### Operation

Destroys the specified bitmap cached for the canvas *myCanvas*.

## export

### Declaration

```
void export(DBE myCanvas,
            string fileName,
            string formatName)
```

### Operation

Exports the specified canvas to the specified file in the specified format, which can be one of these values:

<b>formatName</b>	<b>Format</b>	<b>Platforms</b>
"EPS"	Encapsulated PostScript <sup>®</sup>	All
"EMF"	Enhanced Metafile	Windows



<b>formatName</b>	<b>Format</b>	<b>Platforms</b>
"WMF"	Windows Metafile	Windows
"PICT2"	Macintosh native picture format	All
"HTML"	HTML to drive Java <sup>®</sup> applet	All

---

## print

---

### Declaration

```
void print(DBE myCanvas,
          real hScale,
          real vScale)
```

### Operation

Prints the specified canvas, horizontally scaled by *hScale* and vertically scaled by *vScale*. The width of the printed image is *hScale* times the width of the on-screen image. The height of the printed image is *vScale* times the height of the on-screen image.

---

## startPrintJob, endPrintJob

---

### Declaration

```
void startPrintJob(string title)
void endPrintJob()
```

### Operation

This enables you to package up several prints into one job, to avoid having the Print dialog box shown repeatedly.

### Example

```
// Canvas printing demo
int counter = 1
DB theBox = centered "Canvas print demo"
DBE tog, canv
void repaint(DBE canv) {
    realBackground(canv, realColor_White)
    font(canv, 1,1)
    draw(canv, 150, 150, "This is page " counter
        "")
}
```

```

void getSettings() {
    bool b = get tog
    showPrintDialogs b
}

void printOne(DB xx) {
    getSettings
    counter = 1
    print(canv, 1.0, 1.0)
}

void printThree(DB xx) {
    getSettings
    startPrintJob "Batch print job"
    counter = 1
    print(canv, 1.0, 1.0)
    counter = 2
    print(canv, 1.0, 1.0)
    counter = 3
    print(canv, 1.0, 1.0)
    endPrintJob
    counter = 1
}

canv = canvas(theBox, 400, 400, repaint)
tog = toggle(theBox, "Show dialogues",
             showPrintDialogs())
apply(theBox, "Print one", printOne)
apply(theBox, "Print three", printThree)
show theBox

```

---

## Complex canvases

This section defines functions for dialog box canvases, which support all the functions of the standard Rational DOORS windows, such as in-place editing, tool tips, header bars, scroll bars, menu bars, status bars, tool bars, and tool bar combo boxes. Normally, canvases do not have these dialog box elements, but functions are available to implement them.

---

### In-place editing

---

There are three types of in-place editors available in each canvas. They are selected through the following constants:

<code>inPlaceString</code>	specifies a line editor
<code>inPlaceText</code>	specifies a text editor

`inPlaceChoice` provides a drop-down list of choices

In-place editing is normally disabled on canvases. The `hasInPlace` function defines an in-place edit callback function, and enables the editors.

---

## hasInPlace

---

### Declaration

```
void hasInPlace(DBE da, void cb(DBE el, event))
```

### Operation

The callback function is called on one of two event types. The event type is the second argument passed to callback function with one of the following values:

<code>inPlaceTextFilled</code>	the text box is full and needs to be expanded
<code>inPlaceTextChange</code>	the text box contents has been modified

---

## inPlaceMove

---

### Declaration

```
void inPlaceMove(DBE da, editor, int x, int y, int w, int h)
```

where:

<code>editor</code>	is one of the in-place editors: <code>inPlaceString</code> , <code>inPlaceText</code> , or <code>inPlaceChoice</code>
---------------------	---

### Operation

Moves the specified type of editor to the given location within the canvas.

---

## inPlaceShow

---

### Declaration

```
void inPlaceShow(DBE da, editor, bool showing)
```

where:

<code>editor</code>	is one of the in-place editors: <code>inPlaceString</code> , <code>inPlaceText</code> , or <code>inPlaceChoice</code>
---------------------	---

## Operation

Displays or hides the specified type of editor, at the location defined by the `inPlaceMove` function, depending on the value of *showing*.

This function automatically triggers the repaint callback.

## inPlaceChoiceAdd

### Declaration

```
void inPlaceChoiceAdd(DBE da, string item)
```

### Operation

Adds an option to the in-place choice editor.

## inPlaceCut, inPlaceCopy, inPlacePaste

### Declaration

```
void inPlace{Cut|Copy|Paste}(DBE da, editor)
```

where:

*editor* is one of the in-place editors: `inPlaceString`, `inPlaceText`, or `inPlaceChoice`

### Operation

Perform cut, copy, or paste operations on the contents of the in-place text or string editor.

## inPlaceGet

### Declaration

```
{string|int} inPlaceGet(DBE da, editor)
```

where:

*editor* is one of the in-place editors: `inPlaceString`, `inPlaceText`, or `inPlaceChoice`

### Operation

Returns the in-place editor specified by *editor*. The return value is a string for the text or string editors, and an integer for the choice editor.

---

## inPlaceSet

---

### Declaration

```
void inPlaceSet(DBE da, editor, {string s|int i})
```

where:

*editor* is one of the in-place editors: `inPlaceString`, `inPlaceText`, or `inPlaceChoice`

### Operation

Sets the text or string editor to have the value *s*, or sets the choice editor to have the value *i*.

---

## inPlaceReset

---

### Declaration

```
void inPlaceReset(DBE da, editor)
```

where:

*editor* is one of the in-place editors: `inPlaceString`, `inPlaceText`, or `inPlaceChoice`

### Operation

Resets the specified editor to have no value.

---

## inPlaceTextHeight

---

### Declaration

```
int inPlaceTextHeight(DBE da)
```

### Operation

Returns the number of lines of text displayed in the text editing box.

---

## addToolTip

---

### Declaration

```
void addToolTip(DBE canvas,
               int xpos,
               int ypos,
               int activeWidth,
               int activeHeight,
               type userData
               string toolTipCallback(DBE, type))
```

### Operation

Adds a tool tip to the area of a canvas defined by *xpos*, *ypos*, *activeWidth* and *activeHeight*. The upper left corner of the rectangle is defined by *xpos* and *ypos*.

When the canvas is displayed, if the user places the cursor over this rectangle, the callback function is called with *canvas* as the first argument and the *userData* specified in the call to *addToolTip* as the second argument. The *userData* argument can be of any type. The *toolTipCallback* function returns a string, which is displayed at the cursor's position as a tool tip.

You can use *userData* to customize the tool tip message, so that a single callback function can display different messages depending on the area from which it was activated.

### Example

This example produces a tool tip, which appears as: The cursor is in the [upper|lower] [left|right] corner.

```
DB box = create "Tooltip example"

string toolTipCallback(DBE xx, string mystring) {
    return "The cursor is in the " mystring "
           corner"
}

void repaint(DBE c)
{
    clearToolTips c
    addToolTip(c, 0, 0, 100, 100, "upper left",
              toolTipCallback)
    addToolTip(c, 0, 100, 100, 100, "lower left",
              toolTipCallback)
    addToolTip(c, 100, 0, 100, 100, "upper right",
              toolTipCallback)
    addToolTip(c, 100, 100, 100, 100, "lower
    right", toolTipCallback)
}

DBE canvasWithTips = canvas(box, 200, 200, repaint)
```

show box

---

## clearToolTips

---

### Declaration

```
void clearToolTips(DBE canvas)
```

### Operation

Removes all tool tips associated with *canvas*.

---

## hasHeader

---

### Declaration

```
void hasHeader(DBE da,
               void cb(DBE el, headerEvent, int hIndex, int param))
```

### Operation

This function prepares a canvas for headers. It sets a canvas to have a header bar, and defines a callback. This callback is called by one of the four possible event types, through one of the following constants:

<code>headerResize</code>	a header has been resized; <i>hIndex</i> specifies which heading was changed, and <i>param</i> is its new width
<code>headerEdit</code>	header <i>hIndex</i> was double-clicked to request an edit operation
<code>headerSelect</code>	header <i>hIndex</i> was single-clicked to select
<code>headerReorder</code>	header <i>hIndex</i> was dragged into position <i>param</i>

---

## headerAddColumn

---

### Declaration

```
void headerAddColumn(DBE da, string title, int width)
```

### Operation

Adds a header, with the specified title and width. If there is no header selected, the new column appears at the right of the header bar; otherwise it appears to the left of the currently selected header.

---

## headerChange

---

### Declaration

```
void headerChange(DBE da, int index, string title, int width)
```

## Operation

Changes the title and width of the header specified by *index*.

---

## headerRemoveColumn

---

### Declaration

```
void headerRemoveColumn(DBE da, int index)
```

### Operation

Deletes the header specified by *index* from the header bar.

---

## headerReset

---

### Declaration

```
void headerReset(DBE da)
```

### Operation

Removes all the headers defined for the canvas, typically before adding new ones.

---

## headerSelect

---

### Declaration

```
void headerSelect(DBE da, int index)
```

### Operation

Sets header *index* to be selected.

---

## headerSetHighlight

---

### Declaration

```
void headerSetHighlight(DBE da, int index, int highlight)
```

### Operation

Sets highlight *highlight* in header *index*. Valid highlight indices are 0 and 1; 0 is the upper indicator, 1 is the lower indicator.



---

## headerShow

---

### Declaration

```
void headerShow(DBE da, bool onOff)
```

### Operation

Turns header display on or off in the canvas. Headers must already have been enabled for them to be displayed.

---

## hasScrollbars

---

### Declaration

```
void hasScrollbars(DBE da,
                  void cb(DBE canv,
                          ScrollEvent Event,
                          ScrollSide scrollBar,
                          int newPos,
                          int oldPos))
```

### Operation

This function prepares a canvas for scroll bars. It sets a canvas to have scroll bars, and defines a callback. The callback is called with one of the seven possible event types defined through the following constants:

<code>scrollToEnd</code>	The thumb has been dragged to the bottom or right-hand end of the bar.
<code>scrollToHome</code>	The thumb has been dragged to the top or left-hand end of the bar.
<code>scrollPageUp</code>	The user has clicked in the trough above or to the left of the thumb.
<code>scrollPageDown</code>	The user has clicked in the trough below or to the right of the thumb.
<code>scrollUp</code>	The user has clicked on the left, or up button section of the scroll bar.
<code>scrollDown</code>	The user has clicked on the right, or down button section of the scroll bar.
<code>scrollToPos</code>	The user has dragged the scroll bar to a new position using the thumb.

In each case, the arguments passed to the callback function are as follows:

<code>canv</code>	The canvas to which the event applies.
<code>event</code>	One of the scroll events above.

<i>scrollBar</i>	Either <code>vertical</code> or <code>horizontal</code> to indicate the scroll bar to which the event applies.
<i>new</i>	The new thumb position.
<i>old</i>	The previous thumb position.

---

## scrollSet

---

### Declaration

```
void scrollSet(DBE da, scrollBar, int maxPos, int view, int pos)
```

### Operation

This function sets the position and size of the thumb; *maxPos* is the maximum possible position, *view* is the size of the thumb, and *pos* is the position to which the start of the thumb is to be moved. When the thumb is at *maxPos*, the end of the thumb is at *maxPos+view*, making the length of the scroll bar *maxPos+view*. The *scrollBar* argument can be `vertical` or `horizontal`.

### Example

In this example, the thumb has a size of 1 and can move between 0 and 3. The total length of the scroll bar is 4.

```
scrollSet(can, horizontal, 3, 1, 0)
```

---

## menuBar

---

### Declaration

```
DBE menuBar(DB box)
```

### Operation

Creates a menu bar within a dialog box. The menu bar automatically appears at the top of the window. Returns a DBE, which must be used for adding menus to the menu bar.

---

## statusBar

---

### Declaration

```
DBE statusBar(DB box,
              string initial,
              int sectionEndPoints[ ]
              [,int noOfSections])
```

### Operation

This function creates a status bar within a dialog box. The status bar automatically appears at the bottom of the window. The returned DBE must be used for displaying status values.

Status bars contain a number of text areas, which are specified by their *end point* in pixels. To create a status bar with three areas of 100, 120, and 150 pixels, you must specify `sectionEndPoints` as:

```
{100, 220, 370}
```

You can opt to have either a fixed-size array, and omit `noOfSections`, or a dynamically filled array, in which case specify the number of sections in `noOfSections`.

When creating status bars, you should ensure that any dialog box button elements are hidden.

To place a message in the status bar, use the `set (status bar message)` function.

---

## Menus, status bar and tool bars example

---

```
#include <utils/icons.inc>
nt backColor = colorYellow
int sizes[] = {150, 300}
DB menuDemo = create "Menu Demo"
void doClose(DB x) {
    hide x
}
close(menuDemo, false, doClose)
BE mb = menuBar(menuDemo)
DBE sb = statusBar(menuDemo, "Initial", sizes)
void repaint(DBE c) {
    background(c, backColor)
}
DBE canv = canvas(menuDemo, 300, 200, repaint)
string entries[] = {"Size",
                   ">Small",
                   ">Normal",
                   ">Large",
                   "Style",
                   ">Bold",
                   ">Italic"}
char mn[] = {'S',
            'm',
            'N',
            'L',
            't',
            'B',
            'I'}
```

```

har hot[]      = {ddbNone,
                  ddbNone,
                  ddbNone,
                  ddbNone,
                  ddbNone,
                  ddbNone,
                  ddbNone}

string help[]  = {"Set size",
                  "Small fonts",
                  "Normal fonts",
                  "Large fonts",
                  "Set style",
                  "Bold font",
                  "Italic font"}

string inactive[]= {"Never",
                    "Never",
                    "Never",
                    "Never",
                    "Never",
                    "Never",
                    "Never"}

Sensitivity sensitive(int index) {
    if (index == 2 || index == 6)
        return ddbChecked
    return ddbAvailable
}

void cb(int index) {
    ack "Menu " help[index] " activated"
}

addMenu(mb, "Format", 'F', entries, mn, hot,
        help, inactive, sensitive, cb)

show menuDemo

```

This generates the following dialog box:



---

## Toolbars

This section defines functions for using toolbars in dialog boxes, module windows and canvases.

---

### toolBar

#### Declaration

```
DBE toolBar(DB Box
    [, string name,
    Sensitivity mappingCallback()],
    ToolType types[],
    int param[],
    string toolTip[],
    string help[],
    string inactiveHelp[]
    [, int noOfTools],
    Sensitivity sensitive(int entryIndex),
    void callback(int entryIndex)
    [, bool newRow,
    bool showName])
```

#### Operation

Creates a tool bar within a dialog box. Tool bars can be displayed anywhere in a dialog box and can be placed either with constraints or with the normal automatic placement. Normally tool bars appear between a menu bar and a canvas, which is usually followed by a status bar.

Tool bar contents are specified as arrays all containing the same number of elements. To use fixed-size arrays all containing the same number of elements, omit *noOfTools*. To use freely-defined arrays, specify the minimum number of elements in *noOfTools*.

The arguments passed to the function are defined as follows:

<i>types</i>	the type of the tool, which can have one of the following values:
<code>toolButton</code>	A regular click-to-activate icon.
<code>toolToggle</code>	A toggle in/out icon.
<code>toolRadio</code>	A mutually exclusive toggle icon.
<code>toolCombo</code>	A drop-down list of strings.
<code>toolSpacer</code>	A larger gap.
<code>toolEditableCombo</code>	A drop down list of strings plus an area in which to enter new strings.
<i>param</i>	For a <code>toolButton</code> or <code>toolToggle</code> , this is the id of the icon; the include file <code>utils/icons.inc</code> defines all the icons available as constants; for a <code>toolCombo</code> , it specifies the width of the drop-down list in pixels; there is no value for <code>toolSpacer</code> .
<i>toolTip</i>	String that is displayed in the tool tip for this tool.
<i>help</i>	String that is displayed in the status bar of the window, if one exists, as the user passes the mouse over an active tool.
<i>inactiveHelp</i>	String that is displayed in the status bar of the dialog box, if one exists, as the user passes the mouse over an inactive tool.

Two callback functions are required: one to determine whether tools are sensitive, and one that is called when a tool is activated. `sensitive(int entryIndex)` is called for each entry when the toolbar is first displayed or when the `updateToolBars` function is called.

The function must return one of the following values:

<code>ddbUnavailable</code>	The tool\toolbar is unavailable.
<code>ddbAvailable</code>	The tool\toolbar is active.
<code>ddbChecked</code>	The tool\toolbar is active and has a check beside it.
<code>ddbInvisible</code>	The tool\toolbar is not shown

When the user selects an entry, `callback(int entryIndex)` is called with the index of the tool, and your program must perform the appropriate operation. For both `sensitive` and `callback` functions, `entryIndex` starts at 0, and counts up, so there is a direct correspondence between the array elements and the index returned by the menu.

Name and callback function parameters are optional, as well as booleans determining whether the toolbar is allocated a new row in the container, and whether the name is shown.

If the `name` parameter is specified, the toolbar will be hosted within a container control at the top of the dialog, if not, the toolbar will be generated on the canvas. If `name` is specified then `newRow` and `showName` are mandatory.

The callback function determines how the toolbar option will appear in the context menu for the container control. The possible return values are the same Sensitivity values listed in the table above.

There is also another `ToolType` available: `ToolEditableCombo`. It behaves the same as `ToolCombo`, except the text in the editable area of the combo box is editable, for example a drop-down list of strings plus an area to enter new strings into.

## updateToolBars

### Declaration

```
void updateToolBars(DB box)
```

### Operation

Refreshes the state of the tools in all tool bars in dialog box `box`.

## toolBarComboGetSelection

### Declaration

```
{string|int} toolBarComboGetSelection(DBE tb, int index)
```

### Operation

Returns the string value of the currently selected option or the index of the currently selected option. The `index` argument specifies which tool is to be processed, counting from 0. All tools are included in the count.

## toolBarComboGetItem

### Declaration

```
string toolBarComboGetItem(DBE tb, int cIndex, int iIndex)
```

### Operation

Returns the string value of option `iIndex` in the tool bar combo box specified by `cIndex`. The `iIndex` argument specifies which tool is to be processed, counting from 0. All tools are included in the count.

## toolBarComboSelect

### Declaration

```
void toolBarComboSelect(DBE tb, int index, {string item|int position})
```

## Operation

Selects the option with value *item* (or in indexed *position*) in the tool bar combo box. The *index* argument specifies which tool is to be processed, counting from 0.

## toolBarComboCount

### Declaration

```
int toolBarComboCount(DBE tb, int index)
```

### Operation

Returns the number of options in the tool bar combo box. The *index* argument specifies which tool is to be processed, counting from 0.

## toolBarComboEmpty

### Declaration

```
void toolBarComboEmpty(DBE tb, int index)
```

### Operation

Deletes all the options in the tool bar combo box. The *index* argument specifies which tool is to be processed, counting from 0.

## toolBarComboAdd

### Declaration

```
void toolBarComboAdd(DBE tb, int index, string item)
```

### Operation

Adds an option with value *item* at the end of the tool bar combo box. The *index* argument specifies which tool is to be processed, counting from 0.

## toolBarComboInsert

### Declaration

```
void toolBarComboInsert(DBE tb, int index, int position, string item)
```

### Operation

Adds an option with value *item* at the specified *position* of the tool bar combo box list. If the *position* parameter is -1, the item is added to the end of the list. The *index* argument specifies which tool is to be processed, counting from 0.



---

## toolBarComboDelete

---

### Declaration

```
void toolBarComboDelete(DB tb, int index, int position)
```

### Operation

Used to delete a record within a drop down combo. Takes the *position* in the list of the item to be deleted. The first item has an index of 0. The *index* argument specifies which tool is to be processed, counting from 0.

---

## toolBarVisible

---

### Declaration

```
bool toolBarVisible({Module mod|DBE toolbar|DB box, string name})
```

### Operation

Used to retrieve the visibility state of a toolbar. Only applies to toolbars that are hosted within the appropriate container control (those that were created with the name parameter specified).

---

## toolBarMove

---

### Declaration

```
void toolBarMove({Module mod|DBE toolbar|DB box, string name},
                 int iposition,
                 bool newRow)
```

### Operation

Used to change the position of a toolbar. The toolbar is identified differently depending on which parameters are supplied. This method applies only to toolbars that are hosted within the appropriate container control (those that were created with the name parameter specified).

The *newRow* parameter defines whether the toolbar is shown on a new row within the ReBar control or not.

---

## toolBarShow

---

### Declaration

```
void toolBarShow({Module mod|DBE toolbar|DB box, string name}, bool bShow)
```

### Operation

Used to change the visibility of a toolbar, as identified by the supplied parameters. Applies only to toolbars that are hosted within the appropriate container control, (those that were created with the name parameter specified).

---

## createEditableCombo

---

### Declaration

```
void createEditableCombo({linksetCombo|viewCombo|helpCombo})
```

### Operation

Creates an editable combo box in a tool bar in a module or user-created dialog box

---

## toolBarComboGetEditBoxSelection

---

### Declaration

```
string toolBarComboGetEditBoxSelection(DBE toolbar, int index)
```

### Operation

Returns the selected text from the editable combo box in *toolbar* where *index* is the combo box index.

---

## toolBarComboCutCopySelectedText

---

### Declaration

```
void toolBarComboCutCopySelectedText(DBE toolbar, int index, bool cut)
```

### Operation

Cuts, or copies, the selected text in the editable combo box in *toolbar* at location *index*. If *cut* is *true*, the selected text is cut to the clipboard. Otherwise, it is copied.

---

## toolBarComboPasteText

---

### Declaration

```
void toolBarComboPasteText(DBE toolbar, int index)
```

### Operation

Pastes text from the clipboard into the combo box located at *index* in *toolbar*. Replaces selected text if there is any.

---

## Colors

This section defines constants and a function that allow you to use color in dialog boxes within Rational DOORS. Colors can be used with attribute types and with canvas dialog box elements.

---

## Logical colors

---

Logical colors are defined on the options menu.

### Declaration

```
const int color
```

where *color* can be one of the following:

```
logicalCurrentObjectOutline
```

```
logicalGridLines
```

```
logicalDefaultColor
```

```
logicalPageBackgroundColor
```

```
logicalTextBackgroundColor
```

```
logicalCurrentBackgroundColor
```

```
logicalCurrentCellBackgroundColor
```

```
logicalTitleBackgroundColor
```

```
logicalReadOnlyTextBackgroundColor
```

```
logicalUnlockedTextBackgroundColor
```

```
logicalDataTextColor
```

```
logicalTitleTextColor
```

```
logicalSelectedTextColor
```

```
logicalReadOnlyTextColor
```

```
logicalDeletedTextColor
```

```
logicalHighIndicatorColor
```

```
logicalMediumIndicatorColor
```

```
logicalLowIndicatorColor
```

```
logicalGraphicsBackgroundColor
```

```
logicalGraphicsShadeColor
```

```
logicalGraphicsElideBoxColor
```

```
logicalGraphicsTextColor
```

```
logicalGraphicsBoxColor
```

```
logicalGraphicsLinkColor
```

```
logicalGraphicsCurrentColor
```

```
logicalGraphicsSelectedColor
```

```
logicalGraphicsBoxEdgeColor
```

logicalLinkPageBackgroundColor  
logicalLinkTextBackgroundColor  
logicalLinkCurrentBackgroundColor  
logicalLinkTitleBackgroundColor  
logicalLinkDataTextColor  
logicalUser1Color  
logicalUser2Color  
logicalUser3Color  
logicalUser4Color  
logicalUser5Color  
logicalPageBackgroundFilterColor  
logicalPageBackgroundSortColor  
logicalPageBackgroundFilterSortColor  
logicalTitleBackgroundColor  
logicalInPlaceTextColor  
logicalInPlaceBackgroundColor  
logicalPartitionOutTextColor  
logicalPartitionInReadTextColor  
logicalPartitionInWriteTextColor  
logicalHighlightURLColor  
logicalLinksOutIndicatorColor  
logicalLinksInIndicatorColor  
logical0IndicatorColor  
logical111IndicatorColor  
logical22IndicatorColor  
logical33IndicatorColor  
logical44IndicatorColor  
logical55IndicatorColor  
logical66IndicatorColor  
logical77IndicatorColor  
logical88IndicatorColor  
logical100IndicatorColor  
logicalPrintPreviewBackgroundColor  
logicalPrintPreviewPageColor

```
logicalPrintPreviewTextColor  
logicalPrintPreviewShadeColor
```

---

## Actual colors

---

Actual colors are dependent on the default Rational DOORS setup. These might not make sense if you change your color options.

### Declaration

```
const int color
```

where *color* can be one of:

```
colorLightBlue  
colorMediumLightBlue  
colorDarkTurquoise  
colorPink  
colorBlue  
colorMaroon  
colorRed  
colorYellow  
colorGreen  
colorMagenta  
colorCyan  
colorWhite  
colorOrange  
colorBrown  
colorBlack  
colorGrey82  
colorGrey77  
colorRedGrey  
colorGrey
```

---

## Real colors

---

Real colors are the colors you assign to logical colors.

### Declaration

```
const int color
```

where *color* can be one of:

```
int realColor_Light_Blue2
int realColor_Light_Blue
int realColor_Dark_Turquoise
int realColor_Pink
int realColor_Blue
int realColor_Maroon
int realColor_Red
int realColor_Yellow
int realColor_Green
int realColor_Cyan
int realColor_Magenta
int realColor_White
int realColor_Orange
int realColor_Brown
int realColor_Purple
int realColor_Navy
int realColor_Sea_Green
int realColor_Lime_Green
int realColor_Rosy_Brown
int realColor_Peru
int realColor_Red_Grey
int realColor_Firebrick
int realColor_Thistle
int realColor_Grey82
int realColor_Grey77
int realColor_Grey66
int realColor_Grey55
int realColor_Grey44
int realColor_Grey33
int realColor_Grey22
int realColor_Grey11
int realColor_Black
int realColor_NewGrey1
```

```
int realColor_NewGrey2
int realColor_NewGrey3
int realColor_NewGrey4
```

Real colors are applied using the `realBackground` and `realColor` functions.

## getLogicalColorName

### Declaration

```
string getLogicalColorName(int logicalColor)
```

### Operation

Returns the name of *logicalColor*, which can be any of the values defined in “Logical colors,” on page 589.

## getRealColor

### Declaration

```
int getRealColor(int logicalColor)
```

### Operation

Returns the actual color value assigned to *logicalColor*, which can be any of the values defined in “Real colors,” on page 591.

## getRealColorIcon

### Declaration

```
Icon getRealColorIcon(int realColorIndex)
```

### Operation

Returns the icon of *realColorIndex*, which can be any of the values defined in “Real colors,” on page 591. The icon is for use in a list view or tree view that is all the specified color.

## getRealColorName

### Declaration

```
string getRealColorName(int realColor)
```

### Operation

Returns the name of *realColor*, which can be any of the values defined in “Real colors,” on page 591.

---

## setRealColor

---

### Declaration

```
string setRealColor(int logicalColor,
                   int realColor)
```

### Operation

Sets *logicalColor* (which can have any of the values defined in “Logical colors,” on page 589) to *realColor* (which can be any of the values defined in “Real colors,” on page 591).

### Example

This example sets the logical data text color to green:

```
setRealColor(logicalDataTextColor,
             realColor_Green)
```

---

## Simple placement

This section defines the simple, more or less automatic placement mechanism. This enables you to specify where to place the next element, relative to the previous one. A fully constrainable mechanism is described in “Constrained placement,” on page 597.

---

## beside

---

### Declaration

```
void beside(DB box)
```

### Operation

Places the next element to the right of the last one.

---

## below(element)

---

### Declaration

```
void below(DB box)
```

### Operation

Places the next element below the last one, and aligned with it.



---

## left

---

### Declaration

```
void left(DB box)
void flushLeft(DB box)
```

### Operation

Places the next element below the last one, at the left of the dialog box.

The `flushLeft` function is only provided for v2.1 compatibility.

---

## leftAligned

---

### Declaration

```
void leftAligned(DB box)
```

### Operation

Places the next element in the column at the left-hand side of the dialog box. This is the default placement option: if there are no other alignment options specified items are aligned in a single column.

---

## right

---

### Declaration

```
void right(DB box)
void flushRight(DB box)
```

### Operation

Places the next element below the last one, at the right of the dialog box.

The `flushRight` function is only provided for v2.1 compatibility.

---

## opposite

---

### Declaration

```
void opposite(DB box)
```

### Operation

Places the next element on the same row as the last one, but aligned with the right of the dialog box. After creating the next element another placement mode must be set.

---

## full

---

### Declaration

```
void full(DB box)
```

### Operation

Specifies that subsequent elements are created at full window width. Labels are aligned on the left; the data area is stretched to be aligned to the right edge of the window. When the dialog box is resized, the element resizes with it. This is most useful with field elements.

---

## stacked

---

### Declaration

```
void stacked(DBE element)
```

### Operation

Stacks this dialog-box element on top of the preceding one. This is most useful when building an attribute value editor dialog box. Obviously it does not make sense to leave several stacked elements visible, so this is normally used in conjunction with `hide`.

### Example

```
string enums[] = {"one", "two", "three"}
DB dbBox = "Stacked Example"
DBE stringEdit = field(dbBox, "String:", null,
                      20, false)
DBE enumEdit = choice(dbBox, "Enum:", enums, 3,
                     0)

stacked enumEdit
hide enumEdit
DBE intEdit = slider(dbBox, "Int:", 0, 100, 0)
stacked intEdit
hide intEdit
show(dbBox)
```

## Constrained placement

This section defines the constrained placement functions, which expose the full power of the Rational DOORS dialog placement mechanism. As with all power, responsibility is required. You can easily create broken dialog boxes with this mechanism. It is intended for experienced users only, especially those who are sufficiently familiar with simple placement to have reached its limitations.

### Constrained placement basics

Here is a standard dialog box, or form:

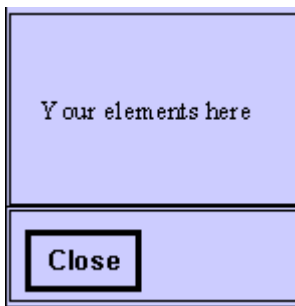

Dialog box elements are attached to each other and to the dialog box on all edges:

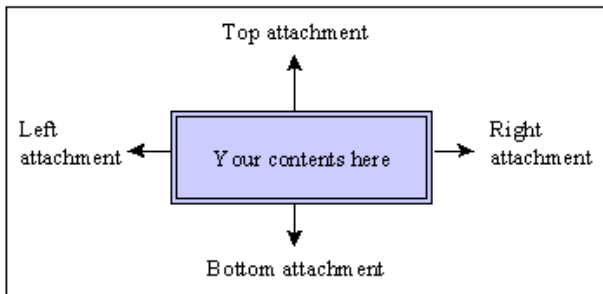

Attachments can be any of the following:

- spaced
- flush
- unattached
- aligned
- inside (normally used within frames or tab strips)

When you place your first element in the dialog box, it has its attachment points connected up for you as follows:

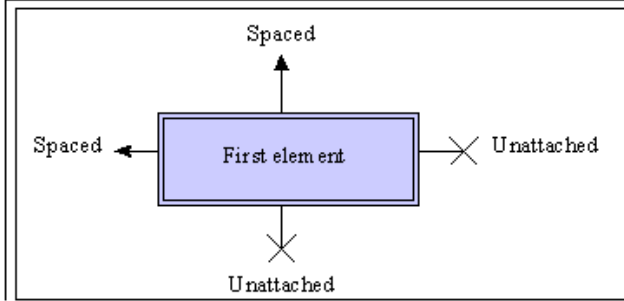

When you add your next DBE, it is hooked up as follows:

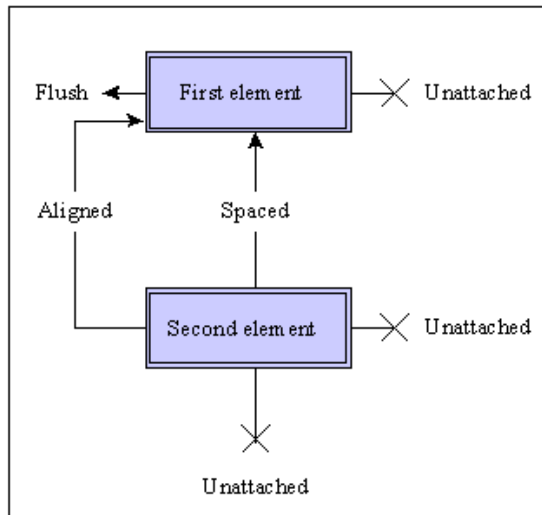

And so on, until the last one is hooked up to the separator as follows:

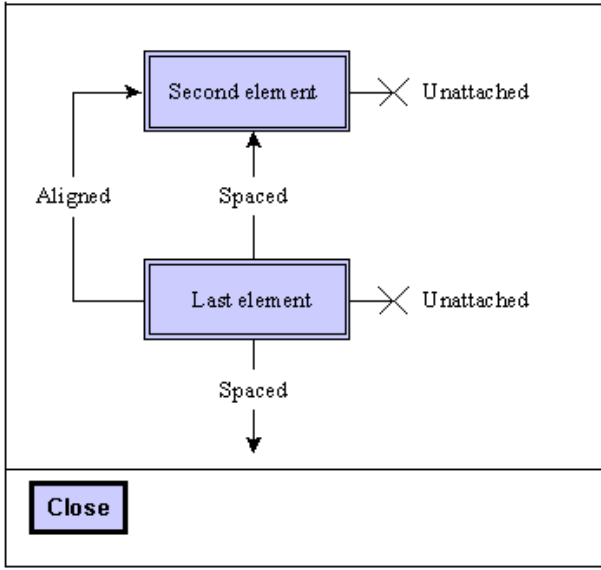

Some elements, such as lists, texts, and canvases, come joined onto the form on both vertical edges:

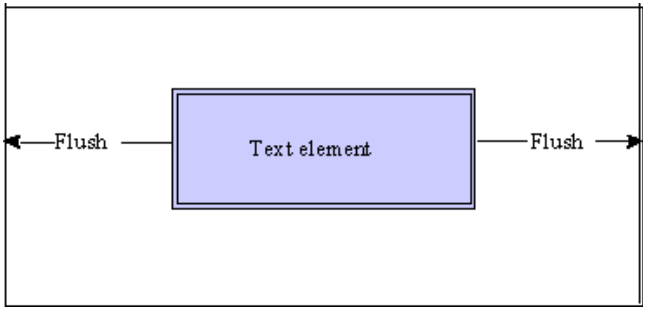

All the other options are implemented in the same style. In implementing a constraint based dialog box layout, it is advisable to draw all the items and their relationships on a piece of paper before encoding them.

---

## Attachment placement

---

The `->` operator is used in constrained placement, as shown in the following syntax:

```
DBE elem -> string side -> string attachment [-> DBE other]
```

where:

*elem*                    Is a dialog box element of type DBE .

<i>side</i>	Is the side the attachment is on: <code>left</code> , <code>right</code> , <code>top</code> or <code>bottom</code> (these are not case sensitive).
<i>attachment</i>	Is the type of attachment: <code>flush</code> , <code>spaced</code> , <code>aligned</code> , <code>unattached</code> , <code>inside</code> or <code>form</code> (these are not case sensitive).
<i>other</i>	Is the dialog box element of type DBE that is the one relative to which placement is to be performed.

The three operators together make a complete specification for the attachment.

**Note:** You must place dialog box elements in the order they are defined. In the following examples, `mylist` must be declared before `otherList`, and `theFrame` must be declared before `theTab` for the placement to work.

### Example

```
mylist->"left"->"unattached"
mylist->"right"->"form"
mylist->"left"->"flush" // not complete
mylist->"left"->"flush"->otherList
theFrame->"left"->"inside"->theTab
theFrame->"right"->"inside"->theTab
theFrame->"top"->"inside"->theTab
theFrame->"bottom"->"inside"->theTab
```

## Worked example

This is a worked example of placing three lists side by side in a dialog box. The first step is to work out the attachments:

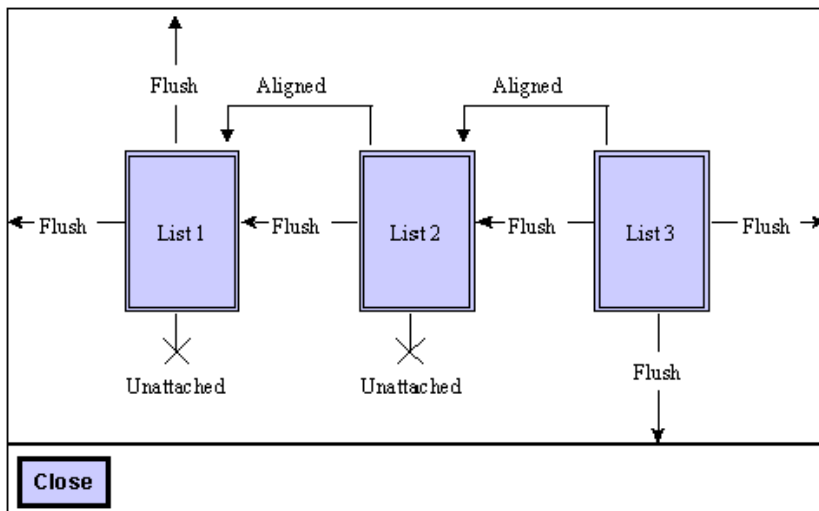

Initially, declare the dialog box and lists:

```
DB threeListBox = create "The Three Lists play Carnegie Hall"
DBE list1 = list(threeListBox, "One", 100, 10, listOneData)
DBE list2 = list(threeListBox, "Two", 100, 10, listTwoData)
DBE list3 = list(threeListBox, "Three", 100, 10, listThreeData)
```

Now connect each one up, remembering to *disconnect* attachments where they would be problematic. This disconnects the first list from the right-hand edge of the form:

```
list1->"right"->"unattached"
```

This connects the left edge of List 2 to the right hand edge of List 1, then aligns the top of List 2 with the top of List 1, and then disconnects the right-hand edge of List 2 from the form:

```
list2->"left"->"flush"->list1
list2->"top"->"aligned"->list1
list2->"right"->"unattached"
```

This does much the same, but note that List 3 remains connected to the form:

```
list3->"left"->"flush"->list2
list3->"top"->"aligned"->list1
```

Instead of aligning the tops of the lists you could connect them all to the form:

```
list1->"top"->"form"
```

```
list2->"top"->"form"
```

```
list3->"top"->"form"
```

but that only works in this case. If List 1 is preceded by another element, for example a field, and you still want the three parallel lists, you need to use alignment.

---

## Constrained placement full example program

---

```
// parallel list DB example
/*
   example of DXL dialog boxes which
   builds parallel lists.
*/
DBE plistBox = create "Parallel lists"
string listOne[] = {"One", "Two", "Three"}
string listTwo[] = {"Un", "Deux", "Trois"}
string listThree[] = {"Uno", "Dos", "Tres"}
DBE l1 = list(plistBox, "English", 80, 5,
              listOne)
DBE l2 = list(plistBox, "French", 80, 5,
              listTwo)
DBE l3 = list(plistBox, "Spanish", 80, 5,
              listThree)
DBE t1 = text(plistBox, null, null, 80, 50,
              false)
DBE t2 = text(plistBox, null, null, 80, 50,
              false)
DBE t3 = text(plistBox, null, null, 80, 50,
              false)
l1->"right"->"unattached"
l2->"left"->"spaced"->l1
l2->"top"->"aligned"->l1
l2->"right"->"unattached"
l3->"left"->"spaced"->l2
l3->"top"->"aligned"->l1
l3->"right"->"form"
t1->"top"->"spaced"->l1
t1->"right"->"unattached"
t2->"left"->"spaced"->t1
```



```

t2->"top"->"spaced"->l2
t2->"right"->"unattached"
t3->"left"->"spaced"->t2
t3->"top"->"spaced"->l3
t3->"right"->"form"
void listSel(DBE l) {
    string w = get l
    DBE t
    if (!null w) {
        if (l == l1) t = t1
        if (l == l2) t = t2
        if (l == l3) t = t3
        set(t, w)
    }
}
set(l1, listSel)
set(l2, listSel)
set(l3, listSel)
show plistBox

```

---

## Progress bar

This section defines functions for the progress bar, which is not a dialog box element as such, but a secondary window that is displayed over the parent window. It contains a title, a message, a progress bar and a **Cancel** button.

---

### progressStart

---

#### Declaration

```

void progressStart(DB box,
                  string title,
                  string message,
                  int limit)

```

#### Operation

Displays the progress bar and window. The *limit* argument specifies the maximum value that is passed to *progressStep*.

---

## progressStep

---

### Declaration

```
void progressStep(int position)
```

### Operation

Moves the progress bar to the given position, which must be between 0 and *limit* defined in the preceding call to `progressStart`. Progress can be forward, backward, or cyclic.

---

## progressMessage

---

### Declaration

```
void progressMessage(string message)
```

### Operation

Sets the message field in the progress window.

---

## progressRange

---

### Declaration

```
void progressRange(string message,  
                  int position,  
                  int limit)
```

### Operation

Specifies new message, position and limit values for the progress bar.

---

## progressCancelled

---

### Declaration

```
bool progressCancelled()
```

### Operation

Returns `true` if the **Cancel** button has been clicked in the progress bar window; otherwise, returns `false`. This can be used to terminate a long-running operation.

---

## progressStop

---

### Declaration

```
void progressStop()
```

### Operation

Removes the progress bar window from the screen.

---

## Progress bar example

---

```
void progCB(DB x) {
    Object o
    int nos = 0
    for o in current Module do nos++
    progressStart(x, "Experiment", "Something",
                 nos)

    nos = 0
    for o in current Module do {
        string h = o."Object Heading"
        progressStep ++nos
        if (null h) h = "null heading"
        progressMessage h

        if (progressCancelled) {
            if (confirm("Exit loop?")) {
                progressStop
                halt
            }
        }
    }

    progressStop
}

if (null current Module) {
    ack "Please run from a module"
    halt
}

DB progressDB = create "Progress test"
label(progressDB, "Demonstration of the progress
        bar")

apply(progressDB, progCB)
```

```
show progressDB
```

---

## DBE resizing

---

---

### setExtraWidthShare(DBE)

---

#### Declaration

```
string setExtraWidthShare(DBE control, real share)
```

#### Operation

Sets the share of any extra width that will go to the DBE when the DB is resized.

*share* should be between 0 and 1.0.

---

### setExtraHeightShare(DBE)

---

#### Declaration

```
string setExtraHeightShare(DBE control, real share)
```

#### Operation

Sets the share of any extra height that will go to the DBE *control* when the DB is resized.

*share* should be between 0 and 1.0.

#### Example

```
DB test = create("Field Test")
DBE rich = richText(test, "Rich Text", "This one should expand", 200, 50, false)
DBE readOnlyRich = richText(test, "Rich Text", "This one should expand", 200,
150, true)
DBE rtfField = richField(test, "Rich Field", "This one should be fixed height",
31, false)
DBE lab = label(test, "A label")
realize(test)
setExtraHeightShare(rich, 0.25)
setExtraHeightShare(readOnlyRich, 0.75)
show test
```

---

## HTML Control

The section describes the DXL support for the HTML control.

**Note:** Some of the functions listed below take an ID string parameter to identify either a frame or an HTML element. In each of these methods, frames or elements nested within other frames are identified by concatenating the frame IDs and element IDs as follows: `<top frame ID>/[<sub frame ID>/...]<element ID>`.

In methods requiring a frame ID, passing `null` into this parameter denotes the top level document.

These methods refer to all frame types including IFRAME and FRAME elements.

---

### htmlView

---

#### Declaration

```
DBE htmlView(DB parentDB, int width, int height, string URL, bool
before_navigate_cb(DBE element, string URL, string frame, string postData), void
document_complete_cb(DBE element, string URL), bool navigate_error_cb(DBE
element, string URL, string frame, int statusCode), void progress_cb(DBE
element, int percentage))
```

#### Operation

Creates an HTML view control where the arguments are defined as follows:

<b>parentDB</b>	<b>The dialog box containing the control.</b>
width	The initial width of the control.
height	The initial height of the control.
URL	The address that will be initially loaded into the control. Can be null to load a blank page (about:blank).

**parentDB**`before_navigate_cb`**The dialog box containing the control.**

Fires for each document/frame before the HTML window/frame navigates to a specified URL. It could be used, amongst other things, to intercept and process the URL prior to navigation, taking some action and possibly also navigating to a new URL.

The return value determines whether to cancel the navigation. Returning `false` cancels the navigation.

Its arguments are defined as follows:

- `element`: The HTML control itself
- `URL`: The address about to be navigated to.
- `frame`: The frame for which the navigation is about to take place.
- `postData`: The data about to be sent to the server if the HTTP POST transaction is being used.

`document_complete_cb`

Fires for each document/frame once they are completely loaded and initialized. It could be used to start functionality required after all the data has been received and is about to be rendered, for example, parsing the HTML document.

Its arguments are defined as follows:

- `element`: The HTML control itself
- `URL`: The loaded address.

`navigate_error_cb`

Fires when an error occurs during navigation. Could be used, for example, to display a default document when internet connectivity is not available.

The return value determines whether to cancel the navigation. Returning `false` cancels the navigation.

Its arguments are defined as follows:

- `elements`: The HTML control itself.
- `URL`: The address for which navigation failed.
- `frame`: The frame for which the navigation failed.
- `statusCode`: Standard HTML error code.

`progress_cb`

Used to notify about the navigation progress, which is supplied as a percentage.

---

## set(html callback)

---

### Declaration

```
void set(DBE HTMLView, bool event_cb(DBE element, string ID, string tag, string event_type))
```

## Operation

Attaches a callback to HTML control element that receives general HTML events. The `ID` argument identifies the element that sourced the event, the `tag` argument identifies the type of element that sourced the event, and the `event_type` argument identifies the event type. Note that the only event types currently supported are `click` and `dblclick`.

If this function is used with an incorrect DBE type, a DXL run-time error occurs.

## set(html URL)

### Declaration

```
void set(DBE HTMLView, string URL)
```

### Operation

Navigates the given *HTMLView* to the given *URL*.

Can only be used to navigate the top level document and cannot be used to navigate nested frame elements.

## setURL

### Declaration

```
void setURL(DBE HTMLView, string ID, string URL)
```

### Operation

Navigates the frame identified by *ID* to the given *URL*. The ID might be null.

## getURL

### Declaration

```
string getURL(DBE HTMLView, string ID)
```

### Operation

Returns the URL for the currently displayed frame as identified by its *ID*. The ID might be null.

## get(HTML view)

### Declaration

```
string get(DBE HTMLView)
```

### Operation

Returns the URL currently displayed in the given *HTMLView*, if there is one.

---

## get(HTML frame)

---

### Declaration

```
Buffer get(DBE HTMLView, string ID)
```

### Operation

Returns the URL for the currently displayed frame as identified by its *ID*.

---

## set(HTML view)

---

### Declaration

```
string set(DBE HTMLView, Buffer HTML)
```

### Operation

Sets the HTML fragment to be rendered inside the <body> tags by the HTML view control directly. This enables the controls HTML to be constructed dynamically and directly rendered.

---

## setHTML

---

### Declaration

```
string setHTML(DBE HTMLView, string ID, Buffer HTML)
```

### Operation

Sets the HTML fragment to be rendered inside the <body> tags by the HTML view controls frame as identified by ID. This enables the HTML of the given document or frame to be constructed dynamically and directly rendered.

**Note:** The contents of the frame being modified must be in the same domain as the parent HTML document to be modifiable. A DXL error will be given on failure (for example, if the wrong type of DBE is supplied).

---

## getHTML

---

### Declaration

```
Buffer getHTML(DBE HTMLView, string ID)
```

### Operation

Returns the currently rendered HTML fragment inside the <body> tags of the document or frame as identified by its *ID*.



---

## getBuffer

---

### Declaration

```
Buffer getBuffer(DBE HTMLView)
```

### Operation

Returns the currently rendered HTML.

---

## getInnerText

---

### Declaration

```
string getInnerText(DBE HTMLView, string ID)
```

### Operation

Returns the text between the start and end tags of the first object with the specified *ID*.

---

## setInnerText

---

### Declaration

```
void setInnerText(DBE HTMLView, string ID, string text)
```

### Operation

Sets the text between the start and end tags of the first object with the specified *ID*.

---

## getInnerHTML

---

### Declaration

```
string getInnerHTML(DBE HTMLView, string ID)
```

### Operation

Returns the HTML between the start and end tags of the first object with the specified *ID*.

---

## setInnerHTML

---

### Declaration

```
void setInnerHTML(DBE HTMLView, string ID, string html)
```

### Operation

Sets the HTML between the start and end tags of the first object with the specified *ID*.

---

**Note:** The `innerHTML` property is read-only on the `col`, `colGroup`, `frameSet`, `html`, `head`, `style`, `table`, `tBody`, `tFoot`, `tHead`, `title`, and `tr` objects.

---

## getAttribute

---

### Declaration

```
string getAttribute(DBE element, string ID, string attribute)
```

### Operation

Retrieves the value for the requested attribute of the first object with the specified value of the `ID` attribute. If the attribute does not exist, null is returned.

Returns null on success. Returns error string on failure, for example if the wrong type of DBE is passed in.

---

## setAttribute

---

### Declaration

```
void setAttribute(DBE element, string ID, string attribute)
```

### Operation

Sets the value of the requested attribute for the first object with the specified value of the `ID` attribute. If the attribute does not exist, it is added to the object.

Displays a DXL error on failure, for example if the wrong type of DBE is passed in.

---

## Example

---

```
DB dlg
DBE htmlCtrl
DBE htmlBtn
DBE html

void onTabSelect(DBE whichTab){
    int selection = get whichTab
}

void onSetHTML(DBE button){
    Buffer b = create
    string s = get(htmlCtrl)
    print s
}
```

```
        b = s
        set(html, b)
        delete b
    }

void onGetInnerText(DBE button){
    string s = getInnerText(html, "Text")
    confirm(s)
}

void onGetInnerHTML(DBE button){
    string s = getInnerHTML(html, "Text")
    confirm(s)
}

void onGetAttribute(DBE button){
    string s = getAttribute(html, "Text", "Align")
    confirm(s)
}

void onSetInnerText(DBE button){
    Buffer b = create
    string s = get(htmlCtrl)
    setInnerText(html, "Text", s)
}

void onSetInnerHTML(DBE button){
    Buffer b = create
    string s = get(htmlCtrl)
    setInnerHTML(html, "Text", s)
}

void onSetAttribute(DBE button){
    Buffer b = create
```

```

    string s = getAttribute(html, "Text", "Align")
    if (s == "left"){
        s = "center"
    }
    else if (s == "center"){
        s = "right"
    }
    else if (s == "right"){
        s = "left"
    }

    setAttribute(html, "Text", "align", s)
}

bool onHTMLBeforeNavigate(DBE dbe, string URL, string frame, string body){
    string buttons[] = {"OK"}
    string message = "Before navigate - URL: " URL "\r\nFrame: " frame
"\r\nPostData: " body "\r\n"
    print message ""
    return true
}

void onHTMLDocComplete(DBE dbe, string URL){
    string buttons[] = {"OK"}
    string message = "Document complete - URL: " URL "\r\n"
    print message ""
    string s = get(dbe)
    print "url: " s "\r\n"
}

bool onHTMLLError(DBE dbe, string URL, string frame, int error){
    string buttons[] = {"OK"}
    string message = "Navigate error - URL: " URL "; Frame: " frame "; Error: "
error "\r\n"
    print message ""
}

```

```

        return true
    }

void onHTMLProgress(DBE dbe, int percentage){
    string buttons[] = {"OK"}
    string message = "Percentage complete: " percentage "%\r\n"
    print message
    return true
}

dlg = create("Test", styleCentered | styleThemed | styleAutoparent)
htmlCtrl = text(dlg, "Field:", "<html><body>\r\n<p id=\"Text\"
align=\"center\">Welcome to <b>DOORS <i>ERS</i></b></p>\r\n</body></html>",
200, false)
htmlBtn = button(dlg, "Set HTML...", onSetHTML)
DBE getInnerTextBtn = button(dlg, "Get Inner Text...", onGetInnerText)
DBE getInnerHTMLBtn = button(dlg, "Get Inner HTML...", onGetInnerHTML)
DBE getAttributeBtn = button(dlg, "Get Attribute...", onGetAttribute)
DBE setInnerTextBtn = button(dlg, "Set Inner Text...", onSetInnerText)
DBE setInnerHTMLBtn = button(dlg, "Set Inner HTML...", onSetInnerHTML)
DBE setAttributeBtn = button(dlg, "Set Attribute...", onSetAttribute)

DBE frameCtrl = frame(dlg, "A Frame", 800, 500)

string strTabLabels[] = {"One", "Two"}
DBE tab = tab(dlg, strTabLabels, 800, 500, onTabSelect)

htmlCtrl->"top"->"form"
htmlCtrl->"left"->"form"
htmlCtrl->"right"->"unattached"
htmlCtrl->"bottom"->"unattached"

htmlBtn->"top"->"spaced"->htmlCtrl
htmlBtn->"left"->"form"
htmlBtn->"right"->"unattached"

```

```
htmlBtn->"bottom"->"unattached"
```

```
getInnerTextBtn->"top"->"spaced"->htmlCtrl
getInnerTextBtn->"left"->"spaced"->htmlBtn
getInnerTextBtn->"right"->"unattached"
getInnerTextBtn->"bottom"->"unattached"
```

```
getInnerHTMLBtn->"top"->"spaced"->htmlCtrl
getInnerHTMLBtn->"left"->"spaced"->getInnerTextBtn
getInnerHTMLBtn->"right"->"unattached"
getInnerHTMLBtn->"bottom"->"unattached"
```

```
getAttributeBtn->"top"->"spaced"->htmlCtrl
getAttributeBtn->"left"->"spaced"->getInnerHTMLBtn
getAttributeBtn->"right"->"unattached"
getAttributeBtn->"bottom"->"unattached"
```

```
setInnerTextBtn->"top"->"spaced"->htmlBtn
setInnerTextBtn->"left"->"aligned"->getInnerTextBtn
setInnerTextBtn->"right"->"unattached"
setInnerTextBtn->"bottom"->"unattached"
```

```
setInnerHTMLBtn->"top"->"spaced"->htmlBtn
setInnerHTMLBtn->"left"->"spaced"->setInnerTextBtn
setInnerHTMLBtn->"right"->"unattached"
setInnerHTMLBtn->"bottom"->"unattached"
```

```
setAttributeBtn->"top"->"spaced"->htmlBtn
setAttributeBtn->"left"->"spaced"->setInnerHTMLBtn
setAttributeBtn->"right"->"unattached"
setAttributeBtn->"bottom"->"unattached"
```

```
frameCtrl->"top"->"spaced"->setInnerTextBtn
frameCtrl->"left"->"form"
```

```
frameCtrl->"right"->"form"
frameCtrl->"bottom"->"form"
```

```
tab->"top"->"inside"->frameCtrl
tab->"left"->"inside"->frameCtrl
tab->"right"->"inside"->frameCtrl
tab->"bottom"->"inside"->frameCtrl
```

```
html = htmlView(dlg, 800, 500, "http://news.bbc.co.uk", onHTMLBeforeNavigate,
onHTMLDocComplete, onHTMLError, onHTMLProgress)
```

```
html->"top"->"inside"->tab
html->"left"->"inside"->tab
html->"right"->"inside"->tab
html->"bottom"->"inside"->tab
```

```
realize(dlg)
show(dlg)
```

---

## HTML Edit Control

The section describes the DXL support for the HTML edit control.

The control behaves in many ways like a rich text area for entering formatted text. It encapsulates its own formatting toolbar enabling the user to apply styles and other formatting.

---

### htmlEdit

---

#### Declaration

```
DBE htmlEdit(DB parentDB, string label, int width, int height)
```

#### Operation

Creates an HTML editor control inside *parentDB*.

---

## htmlBuffer

---

### Declaration

```
Buffer getBuffer(DBE editControl)
```

### Operation

Returns the currently rendered HTML fragment shown in the control. The fragment includes everything inside the <body> element tag.

---

## set(HTML edit)

---

### Declaration

```
void set(DBE editControl, Buffer HTML)
```

### Operation

Sets the HTML to be rendered by the edit control. The HTML fragment should include everything inside, but not including, the <body> element tag.

---

## Example

---

```
DB MyDB = create "hello"
DBE MyHtml = htmlEdit(MyDB, "HTML Editor", 400, 100)

void mycb (DB dlg){

    Buffer b = getBuffer MyHtml
    string s = stringOf b
    ack s
}

apply (MyDB, "GetHTML", mycb)
set (MyHtml, "Initial Text")
show MyDB
```



## Chapter 23

# Templates

This chapter describes template functions and expressions:

- Template functions
- Template expressions

---

## Template functions

This section defines functions that allow you to construct a simple, formal module template: essentially a table of contents. The functions use the `Template` data type. The templates section of the DXL Library contains many examples.

**Note:** If you are creating new DXL files that are to be included in the templates list available in the Rational DOORS client, and the template name, which appears at the top of the DXL file, uses unicode multibyte characters, you must save the DXL file as UTF-8 encoding.

---

### template

#### Declaration

```
Template template(string h)
```

#### Operation

Returns a template that builds a single object with string *h* as its heading.

#### Example

```
Template t = template "trivial"
```

---

### instance

#### Declaration

```
void instance(Template t)
void instance(below(Template t))
```

#### Operation

The first form creates an instance of template *t* immediately after the current object and at the same level, or at the first object position in an empty module.

The second form creates an instance of the template below the current object.

## Example

```
// same level
Template t = template "trivial"
instance t
// below
Template t = template "trivial"
instance below t
```

---

# Template expressions

This section defines the operators used to assemble templates in expressions.

---

## Operators

---

Template expression operators can be used as shown in the following syntax:

```
Template t <> string h
Template t << string h
Template t >> string h
```

Each operator adds an object with heading *h* at a specific level of template *t*, and returns the new template. The levels are:

<>	current level
<<	next level down
>>	next level up

The following syntax can be used to specify a number of levels up:

```
Template t >> int n <> string h
```

In this form, the second operator can be replaced by << or >>.

## Example

This example adds an object at the same level, then another at the level below:

```
Template t = template "A" <> "B" << "B.A"
instance t
```

This example adds an object at the same level, then a series of objects each one level lower. B.A.A.A.A is four levels below A and B; the instance of the new template needs to be at the same level as B, so C is added four levels above B.A.A.A.A:

```
Template t = template "A" <>
    "B" <<
    "B.A" <<
    "B.A.A" <<
    "B.A.A.A" <<
    "B.A.A.A.A" >> 4 <>
    "C"
```

instance t

This example is equivalent to:

```
Template t = template "A" <>
    "B" <<
    "B.A" <<
    "B.A.A" <<
    "B.A.A.A" <<
    "B.A.A.A.A" >> 3 >>
    "C"
```

instance t



## Chapter 24

# Rational DOORS window control

This chapter describes the DXL library and Addins menus. It also defines functions and standard items that control the way Rational DOORS displays information and its windows.

- The DXL Library and Addins menus
- Module status bars
- Rational DOORS built-in windows
- Module menus

---

## The DXL Library and Addins menus

DXL libraries are directories stored in the Rational DOORS file tree. They can be found at `$DOORSHOME/lib/dxl`. Each library must contain a description file for that library with the same name as the directory but with a `.hlp` extension. Only files ending in `.dxl` are recognized as library elements.

The standard directory adds functions to the Rational DOORS formal module **Tools** menu. Each directory in `addins` appears as a new menu in formal modules. Subdirectories appear as submenus.

The order of menu items as well as their names, mnemonics and accelerators are defined in an index file with the same name as the library directory but with a `.idx` extension.

As an example, see the user-defined function `fn.dxl` included in the formal module menus:

```
dxl/addins/addins.hlp
    addins.idx
    user/user.hlp
        user.idx
        fn.dxl
```

---

## Library description file format

Each library must contain a description file for the library with the same name as the directory but with a `.hlp` extension.

The first line of the description file is a one-line description of the library. The rest of the file can expand on this, with descriptive text providing detailed information about the library.

### Example

This example is the start of file: `$DOORSHOME/dxl/addins/acme/acme.hlp`:

The ACME Spindles Inc DXL function library  
 This library contains a set of functions  
 developed by ACME Spindles Inc to support  
 our internal use of Rational DOORS.

---

## Menu index file format

---

Each subdirectory within the `addins` directory can contain a menu index file with the same name as the directory but with a `.idx` extension. Each line of the menu index file must contain:

- DXL file or directory name, without extension
- mnemonic (character used with ALT to access menu from keyboard)
- accelerator (character used with CTRL to access menu from keyboard); an underscore means no accelerator
- menu label

A line containing only hyphens (-) (as in line 3 of the following example), inserts a separator within the menu.

### Example

This example is the first four lines of file `$DOORSHOME/dxl/addins/acme/acme.idx`:

```
comps    C _ Component book
template T _ Templates
-----
parsers  I _ Input parsers
```

---

## Menu DXL file format

---

Each DXL file to be included in the menu must conform to the following comment convention:

- The first line of the file contains a `//` comment with a single-line description of the program, which appears in the DXL Library window.
- This must be followed by a `/* ... */` multi-line comment which describes in more detail what the program does. This can be viewed from the DXL Library window by clicking the **Describe** button.

### Example

```
File: $DOORSHOME/dxl/addins/acme/example.dxl
// A simple example program
/*
This program simply displays an ack box.
*/
ack "This is a Menu DXL example program"
```

---

## Alternative Addins Location

---

Additional addins directories can also be created outside of the standard Rational DOORS installation path. Here are steps on how to create a such a configuration on a Rational DOORS client machine:

- Create the directory where you want to contain your addins library, which can be created on any drive, for example E:\addins. Each library must contain a description file for the library with the same name as the directory but with a .hlp extension. See above for further details.
- Create another directory for your DXL, for example E:\addins\MyDXL. Again, each directory must contain a description file for the library with the same name as the directory but with a .hlp extension. See above for further details.
- Add your DXL, making sure the comment convention used in ‘Menu DXL file format’ above is adhered to.
- Create a Registry string value for your addins:
  - This is created in the key HKEY\_LOCAL\_MACHINE\SOFTWARE\Telelogic\DOORS\*<DOORS version number>*\Config
  - A new string value should be created in this key with ‘Value Name’ set to ‘Addins’ and ‘Value Data’ set to the path of the addins directory, for example E:\addins

---

## Module status bars

This section defines functions for the module window status bar, in which Rational DOORS displays information such as the user name, access rights, or other information. These functions allow your DXL program to place information in the status bar.

---

### status

---

#### Declaration

```
void status(Module m,
            string message)
```

#### Operation

Displays string *message* in the left-most field of the status bar of module *m*.

#### Example

```
status(current Module, "Power validated")
```

---

## menuStatus

---

### Declaration

```
void menuStatus(Module m
                [,string message])
```

### Operation

Displays string *message* in the full status bar area of module *m*, in the same way that help menu explanations are displayed.

If *message* is omitted, the status bar returns to its normal state.

### Example

```
menuStatus(current Module, "Module exported in
          GREN III format")
```

---

## updateToolBars

---

### Declaration

```
void updateToolBars(Module m)
```

### Operation

Redraws the tool bars for module *m*. This might be needed when certain display modes are altered using a DXL program.

---

## Rational DOORS built-in windows

This section gives the syntax for functions that operate on Rational DOORS built-in windows. The functions use an internal data type, so declarations are not stated.

See also “Scrolling functions,” on page 695.

---

## window

---

### Syntax

```
window m
```

### Operation

Returns a handle to the window displaying module *m*, for use in the width and height functions.

### Example

```
print width window current Module
```



---

## show (window)

---

### Syntax

```
show win
```

### Operation

Shows a Rational DOORS built-in window, if it is available.

---

## hide

---

### Syntax

```
hide win
```

### Operation

Hides a Rational DOORS built-in window, if it is showing.

---

## Specific windows

---

### Syntax

```
editor(attrRef)
```

```
print(m)
```

where:

*m* is a module of type Module

*attrRef* is in one of the following formats:

(Object o).(string attrName)

(Module m).(string attrName)

(Link l).(string attrName)

### Operation

These functions return the appropriate window, for use with `show (window)` and `hide`, as follows:

`editor(attrRef)` object attribute editor

`print` print

### Example

```
show editor(current Object)."Status"
```

```
show print current Module
```

---

## Module menus

This section lists constants and gives the syntax for functions that create and manage menus. Many of the functions use internal data types, so declarations are not stated. For examples of how to build menus, look in `$DOORSHOME/lib/dx1/config`.

---

### Standard menus and submenus

---

The following constants are defined as standard menus and submenus:

clipCopyMenu  
clipPasteMenu  
clipboardMenu  
projectMenu  
moduleMenu  
editMenu  
oleMenu  
viewMenu  
objectMenu  
linkMenu  
linksetMenu  
attributeMenu  
columnMenu  
extractMenu  
toolsMenu  
usersMenu  
optionsMenu  
helpMenu  
objCopyMenu  
objCreateMenu  
objMoveMenu  
objUnlockMenu

---

### Standard items

---

The following constants are defined as standard items:

OLECutItem  
OLECopyItem  
OLEPasteItem  
OLEPasteSpecialItem  
OLEClearItem  
OLEInsertItem  
OLERemoveItem  
OLEVerbItem  
attrDefItem  
attrTypeItem  
clipCutItem  
clipCopyFlatItem  
clipCopyHierItem  
clipPasteItem  
clipPasteDownItem  
clipClearItem  
columnCreateItem  
columnEditItem  
columnDeleteItem  
columnLeftJustifyItem  
columnRightJustifyItem  
columnCenterJustifyItem  
columnFullJustifyItem  
columnUseInGraphicsItem  
columnUseAsToolTipsItem  
dispGraphicsItem  
dispOutlineItem  
dispFilterDescendantsItem  
dispFilteringItem  
dispSortingItem  
dispDeletionItem  
dispReqOnlyItem  
dispFilterParentsItem  
dispGraphicsLinksItem

dispGraphicsToolTipsItem  
dispLevelAllItem  
dispLevel1Item  
dispLevel2Item  
dispLevel3Item  
dispLevel4Item  
dispLevel5Item  
dispLevel6Item  
dispLevel7Item  
dispLevel8Item  
dispLevel9Item  
dispLevel10Item  
editDXLItem  
editUsersItem  
EXIT\_Item  
extractSetupItem  
extractSameItem  
extractDownItem  
filterItem  
helpContentsItem  
helpSearchItem  
helpIndexItem  
helpHelpItem  
helpProjManItem  
helpFormalItem  
helpDescriptiveItem  
helpLinkItem  
helpAboutItem  
inplaceRejectItem  
inplaceAcceptItem  
inplaceHeadingItem  
inplaceTextItem  
inplaceAttrItem  
inplaceResetAttrItem

linkCreateItem  
linkEditItem  
linkDeleteItem  
linkSourceItem  
linkTargetItem  
linkMatrixItem  
linkGraphicsItem  
linksetCreateItem  
linksetDeleteItem  
linksetRefreshItem  
modAccessItem  
modAttrEditItem  
modBaselineItem  
modCloseItem  
modHistoryItem  
modLayoutItem  
modPrintItem  
modSaveItem  
modDowngradeItem  
modPrintPreviewItem  
objAccessItem  
objCompressItem  
objUncompressItem  
objCompressionItem  
objCopyItem  
objCopyDownItem  
objCreateItem  
objCreateDownItem  
objDeleteItem  
objUndeleteItem  
objPurgeItem  
objEditItem  
objHistoryItem  
objMoveItem

objMoveDownItem  
objLockItem  
colorOptionsItem  
fontOptionsItem  
optionsSaveItem  
optionsRestoreItem  
optionsDefaultsItem  
pictureItem  
createProjectItem  
openProjectItem  
deleteProjectItem  
undeleteProjectItem  
purgeProjectItem  
duplicateProjectItem  
closeProjectItem  
projectAttrItem  
unlockModulesItem  
purgeModulesItem  
projectArchiveItem  
projectRestoreItem  
createFormalModuleItem  
createLinkModuleItem  
createDescriptiveModuleItem  
openModuleEditItem  
openModuleShareItem  
openModuleReadItem  
deleteModuleItem  
undeleteModuleItem  
purgeModuleItem  
duplicateModuleItem  
renameModuleItem  
archiveModuleItem  
restoreModuleItem  
showFormalModulesItem

```

showLinkModulesItem
showDescriptiveModulesItem
showDeletedModulesItem
showDeletedProjectsItem
sortNameItem
sortTypeItem
sortDescriptionItem
selectItem
deselectItem
sortItem
spellCheckItem
undoItem
redoItem
viewCreateItem
viewShowItem
viewDeleteItem

```

---

## Standard combo box controls

---

The following constants are defined as standard combo box controls:

```

linksetCombo
viewCombo
helpCombo

```

---

## createMenu

---

### Syntax

```

createMenu(menuIdentifier
           [,string label,
            char mnemonic,
            string dxlDirectory])

createMenu(int mappingFunction(),
           string label,
           char mnemonic,
           string dxlFile)

```

## Operation

Creates a standard or configurable menu or submenu, according to context. The arguments are defined as follows:

<i>menuIdentifier</i>	Provides a standard menu definition, which is particularly useful as a source of menu gray-out behavior; for a standard menu, it must take one of the values listed in “Standard menus and submenus,” on page 628.
<i>label</i>	The text of the menu item or null.
<i>mnemonic</i>	The character of the label that is to be used with ALT for keyboard access, or null.
<i>dxlDirectory</i>	Provides the name of a standard-format DXL library directory, or null.
<i>mappingFunction()</i>	<p>Callback function which returns an integer that specifies whether the menu item is available, checked, or invisible; possible values are:</p> <p>menuAvailable_  menuAvailableChecked_  menuUnavailable_  menuInvisible_</p> <p><b>Note:</b> This functionality is not supported for menus created on the module menu bar. It is just for menus within these menu bar menus that have been created. Mapping functions have to be defined in a file inside  \$DOORSHOME\lib\dxl\startupfiles  and cannot be in the same file as the perms that call them.</p>
<i>dxlFile</i>	Full path name of the DXL file containing the menu.

For a standard menu only the *menuIdentifier* is required. For a configurable menu or submenu, *menuIdentifier* provides basic information, including predefined gray-out behavior. In this case it can also be null. If not null, *label* and *mnemonic* override the predefined appearance of the menu. If not null, the contents of *dxlDirectory* are used for the menu.

The second form takes a DXL mapping function as a callback. If not null, the contents of *dxlFile* are used for the menu.

## Example

```
createMenu moduleMenu
```



---

## createButtonBar

---

### Declaration

```
void createButtonBar([string name, Sensitivity mappingCallback(), bool newRow,
bool showName])
```

### Operation

Creates a button bar in a module or user-created dialog box. If the name is supplied the toolbar will be hosted in a container control at the top of the dialog, if not it will be generated on the canvas. The `newRow` parameter defines whether the toolbar is shown on a new row within the container control or not. The `showName` parameter defines whether the name of the toolbar is shown or not. Both `newRow` and `showName` are mandatory when the toolbar is hosted outwith a canvas.

When a user right-clicks within the container control of a dialog, a context menu will be shown to allow the user to show or hide the toolbars inside it. The mapping callback function is called for each toolbar if provided to allow the DXL to control the display of context menu items for the given toolbar. It can be set to null. The function must return one of the following Sensitivity values:

<code>ddbUnavailable</code>	The tool is unavailable.
<code>ddbAvailable</code>	The tool is active.
<code>ddbChecked</code>	The tool is active and has a check beside it.
<code>ddbInvisible</code>	The tool is not shown

---

## createItem

---

### Declaration

```
void createItem(standardItem
                [,string label,
                char mnemonic,
                char accelerator,
                {IconID icon_id|string iconFileName},
                string tooltip,
                string helptext,
                string inactiveHelp,
                string dxlFile])
```

```
void createItem(int mappingFunction(),
                string label,
                char mnemonic,
                char accelerator,
                int modifierKeyFlags,
                {IconID icon_id|string iconFileName},
```

```

        string tooltip,
        string helptext,
        string inactiveHelp,
        string dxlFile)

void createItem(int mappingFunction(),
               void dxlCallback(),
               string label,
               char mnemonic,
               char accelerator,
               int modifierKeyFlags,
               {IconID icon_id|string iconFileName},
               string tooltip,
               string helptext,
               string inactiveHelp)

```

## Operation

Creates a DXL menu item in a module or user-created dialog box. In the first form, if the optional arguments are omitted, creates a standard item. The arguments are defined as follows:

<code>standardItem</code>	Provides a standard menu item definition, which is particularly useful as a source of menu gray-out behavior; it must have one of the values listed in “Standard items,” on page 628.
<code>label</code>	The text of the menu item.
<code>mnemonic</code>	The character of the label that is to be used with ALT for keyboard access or null.
<code>accelerator</code>	The character that is to be used with the CTRL for direct keyboard access or null. This option does not function for pop-up menus.
<code>modifierKeyFlags</code>	Used in conjunction with the <code>accelerator</code> parameter to change which key should be pressed with the accelerator key. Possible values are <code>modKeyNone</code> , <code>modKeyCtrl</code> , <code>modKeyShift</code> and <code>null</code> .
<code>icon_id</code>	The icon identifier of the standard icon, used for button bars only or null; it must have one of the values listed below.
<code>iconFileName</code>	The file to be used as an icon. Must be a valid icon format .ico file.
<code>tooltip</code>	Text to be displayed in the button-bar tooltip or null.
<code>helptext</code>	Text to appear in the status bar for the item (if active) or null.
<code>inactiveHelp</code>	Text to appear in the status bar for the item (if inactive) or null.

<code>dxlFile</code>	Complete path name of the DXL file to execute or null (usually null).
<code>mappingFunction ()</code>	<p>Callback function which returns an integer that specifies whether the menu item is available, checked, or invisible; possible values are:</p> <pre> menuAvailable_ menuAvailableChecked_ menuUnavailable_ menuInvisible_ </pre> <p>Mapping functions have to be defined in a file inside <code>\$DOORSHOME\lib\dxl\startupfiles</code> and cannot be in the same file as the perms that call them.</p>
<code>dxlCallback ()</code>	Callback function which runs when the menu is selected (instead of running a DXL file).

The possible values for `IconID` constants are:

```

levelAllIcon
level1Icon
level2Icon
level3Icon
level4Icon
level5Icon
level6Icon
level7Icon
level8Icon
level9Icon
level10Icon
dispGraphicsIcon
dispOutlineIcon
dispFilterIcon
dispSortIcon
createObjSameIcon
createObjDownIcon
deleteObjIcon
columnInsertIcon

```

columnEditIcon  
columnRemoveIcon  
justifyLeftIcon  
justifyRightIcon  
justifyCenterIcon  
justifyFullIcon  
folderOpenIcon  
folderNewIcon  
folderCloseIcon  
projOpenIcon  
projNewIcon  
projCloseIcon  
editUsersIcon  
createModIcon  
editModIcon  
shareModIcon  
readModIcon  
copyModIcon  
deleteModIcon  
createLinkIcon  
editLinkIcon  
deleteLinkIcon  
matrixModeIcon  
startLinkIcon  
endLinkIcon  
createLinksetIcon  
createFormalModIcon  
createLinkModIcon  
deleteLinksetIcon  
editHeadingIcon  
editTextIcon  
extractObjIcon  
extractOneDownIcon  
showMarkedObjsIcon

spellcheckIcon  
undeleteModIcon  
increaseLevelIcon  
decreaseLevelIcon  
noIcon  
yesIcon  
wordIcon  
projWizIcon  
viewWizIcon  
layWizIcon  
repWizIcon  
repManIcon  
tableCreateIcon  
tableInsertRowIcon  
tableInsertColIcon  
tableSetBordersIcon  
textBold  
textItalic  
textUnderline  
textStrikeThrough  
saveIcon  
printIcon  
propertiesIcon  
copyIcon  
cutIcon  
pasteIcon  
deleteIcon

### Example

```
createItem(linkCreateItem, "Create link", 'C',  
          null, null, null, null, null, null)
```

---

## createCombo

---

### Syntax

```
createCombo ({linksetCombo|viewCombo})
```

### Operation

Creates a standard combo box in a toolbar.

### Example

```
createButtonBar  
separator  
createCombo viewCombo  
separator  
end buttonbar
```

---

## createEditableCombo

---

### Syntax

```
createEditableCombo ({linksetCombo|viewCombo})
```

### Operation

Creates an editable combo box in a toolbar

---

## createPopup

---

### Declaration

```
void createPopup ()
```

### Operation

Creates a popup menu in a module or user-created dialog box.

---

## separator(menu)

---

### Declaration

```
void separator ()
```

### Operation

Adds a menu separator.

---

## end(menu, button bar, popup)

---

### Syntax

```
end ( {menu | buttonbar | popup} )
```

### Operation

Ends a menu, button bar or popup section.

### Example

```
end menu  
end buttonbar  
end popup
```





## Chapter 25

# Display control

This chapter describes DXL functions that control what information is displayed in Rational DOORS module windows.

- Filters
- Compound filters
- Filtering on multi-valued attributes
- Sorting modules
- Views
- View access controls
- View definitions
- Columns
- Scrolling functions
- Layout DXL

---

## Filters

This section defines operators and functions for building display filters.

The data type `Filter` enables the construction of complex filters which can then be applied with the `set` command. The data type `LinkFilter` can take one of the following values:

```
linkFilterIncoming
```

```
linkFilterOutgoing
```

```
linkFilterBoth
```

These enable the construction of filters with reference to incoming links, outgoing links, or both. They are used with the `hasLinks` and `hasNoLinks` functions.

The DXL functions for filtering mimic the capability provided by the Rational DOORS user interface, except for `accept` and `reject`, which allow a DXL program to set an arbitrary filter.

**Note:** If you define an advanced filter and specify a rule such as `<dxlAttribute> contains <sometext>`, the filter runs on all objects in the module when you add the rule to the list of rules. If this creates excessive delays in the filter implementation, you can modify this behavior by replacing the `filter_gui.inc` file. With this modified file, the rule is applied only after you click **Apply**. You are then prompted to apply the rule to each module using the **Next** and **Previous** buttons. The `filter_gui.inc` file is located in the `\lib\dxl\standard\filter` directory. You can obtain the revised file at the technote <http://www.ibm.com/support/docview.wss?uid=swg21585679>. Back up the current `filter_gui.inc` file before replacing it.

---

## attribute(value)

---

This function is used to generate a filter attribute handle, as shown in the following syntax:

```
attribute(string attrName)
```

The returned handle for the attribute named *attrName* is used by other functions.

### Example

This example filters on all objects in the current module that have a "Priority" attribute value of "Mandatory".

```
set(attribute "Priority" == "Mandatory")
```

---

## column(value)

---

### Syntax

```
Filter column(string ColumnName,
              string SearchText
              [, bool CaseSensitive,
              bool RegularExpression])
```

### Operation

Filters on the contents of *ColumnName*. The last two parameters are optional.

---

## Attribute comparison

---

Operators can be used to compare filter attribute handles and text strings.

### Syntax

The syntax for using these operators is as follows:

```
attribute(string attr) operator string text
```

where:

<i>attr</i>	is the name of the attribute
<i>operator</i>	is one of == != < <= > >=
<i>text</i>	is a string

### Operation

Compares the filter attribute handle returned by the call to `attribute` with the string *text*. If *text* is a variable of another type, you can convert it to a string by concatenating it with the empty string.

## Example

This example filters on only those objects in the current module that have attribute "Cost" values greater than 4:

```
set(attribute "Cost" > "4")
// using wrong type
real cost = 4.0
set(attribute "Cost" > cost "")
```

## accept

### Declaration

```
void accept(Object o)
```

### Operation

Marks `object o` as accepted under the current filter. This enables a DXL program to set an arbitrary filter on the current module. Compare with the `reject` function.

## addFilter

### Declaration

```
void addFilter([Module m,]
               Filter f
               int &accepted,
               int &rejected)
```

### Operation

Adds a filter in the current module, or to module `m` where it is specified. The third and fourth parameters pass back the number of objects accepted and rejected respectively under the filter.

## contents

### Declaration

```
Filter contents(string text[, bool caseSensitive[, bool useRegExp]])
```

### Operation

Filters on objects that include the string `text` in any string or text attributes. If `caseSensitive` is set to `true`, the filter takes character case into account when searching. If `caseSensitive` is `false`, the filter ignores case. If `caseSensitive` is omitted, the filter accepts regular expressions.

The optional `useRegExp` parameter enables the use of regular expressions to be specified independently of case sensitivity.

## Example

This example matches objects that contain literally `f.*h`, but not `F.*H`, `f.*H`, or `F.*H`.

```
Filter f = contents("f.*h", true)
```

This example matches objects that contain the regular expression `f.*h`, for example, `fish` or `fourteenth`.

```
Filter f = contents "f.*h"
```

## contains

### Declaration

```
Filter contains(attribute(string attributeName), string text, [bool
caseSensitive[, bool useRegExp]])
```

### Operation

Filters on objects that include the string `text` in a specific attribute `attributeName`. If `caseSensitive` is set to `true`, the filter takes character case into account when searching. If `caseSensitive` is `false`, the filter ignores case. If `caseSensitive` is omitted, the filter accepts regular expressions.

The optional `useRegExp` parameter enables the use of regular expressions to be specified independently of case sensitivity.

### Example

```
Module m = current
Filter f = contains(attribute "Object Text", "shall", false)
set f
filtering on
```

## excludeCurrent

### Declaration

```
Filter excludeCurrent()
```

### Operation

Excludes the current object from the filter.

## excludeLeaves

### Declaration

```
Filter excludeLeaves()
```

## Operation

Excludes leaves from the filter.

## filterTables

### Declaration

```
void filterTables(bool onOff)
bool filterTables(Module m)
```

### Operation

The first form sets whether tables are filtered in the current module.

The second form returns whether table contents are being filtered in the specified module *m*.

## getSimpleFilterType\_

### Declaration

```
int getSimpleFilterType_(Filter)
```

### Operation

Returns the type of the simple filter; attribute, link, object, or column. Please note that the returned value corresponds to the index of the appropriate tab page on the filter dialog. If the specified filter is not a simple filter, -1 is returned.

## getAttributeFilterSettings\_

### Declaration

```
bool getAttributeFilterSettings_(Module,
                                Filter,
                                string& attributeName,
                                int& comparisonType,
                                string& comparisonValue,
                                bool& matchCase,
                                bool& useRegexp)
```

### Operation

Returns details of the specified attribute filter in the return parameters. The function returns `false` if the filter is not a valid attribute filter.

The `comparisonType` parameter returns the internal index of the comparison. This is different to the index that is used in the associated combo box on the filter dialog. The translation is performed by the DXL code.

---

## getLinkFilterSettings\_

---

### Declaration

```
bool getLinkFilterSettings_(Module,
                           Filter,
                           bool& mustHave,
                           int& linkType,
                           string& linkModuleName)
```

### Operation

Returns details of the specified link filter in the return parameters. The function returns `false` if the filter is not a valid link filter.

The `linkType` parameter returns a value that maps directly to the appropriate combo box.

The `linkModuleName` parameter returns an asterisk if links are allowed through any module, or the module name.

---

## getObjectFilterSettings\_

---

### Declaration

```
bool getObjectFilterSettings_(Module,
                              Filter,
                              int& objectFilterType)
```

### Operation

Returns details of the specified object filter in the return parameter. The function returns `false` if the filter is not a valid object filter.

The `objectFilterType` parameter returns a value that maps directly to the radio group on the dialog.

---

## getColumnFilterSettings\_

---

### Declaration

```
bool getColumnFilterSettings_(Module,
                              Filter,
                              string& columnName,
                              string& comparisonValue,
                              bool& matchCase,
                              bool& useRegExp)
```

## Operation

Returns details of the specified column filter in the return parameters. The function returns `false` if the filter is not a valid column filter.

## includeCurrent

### Declaration

```
Filter includeCurrent()
```

### Operation

Includes the current object in the filter.

## includeLeaves

### Declaration

```
Filter includeLeaves()
```

### Operation

Includes leaves in the filter.

## hasLinks

### Declaration

```
Filter hasLinks(LinkFilter value,  
               string linkModName)
```

### Operation

Includes in the filter objects that have links through link module *linkModName*. The string can also take the special value `"*"`, which means any link module. The *value* argument defines the type of links; it can be one of `linkFilterIncoming`, `linkFilterOutgoing`, or `linkFilterBoth`.

### Example

This example filters on objects that have incoming links through any link module:

```
Module m = current  
Filter f = hasLinks(linkFilterIncoming, "*")  
set(m, f)  
filtering on
```

---

## hasNoLinks

---

### Declaration

```
Filter hasNoLinks(LinkFilter value,
                 string modName)
```

### Operation

Includes in the filter objects that have no links through link module *linkModName*. The string can also take the special value "\*", which means any link module. The *value* argument defines the type of links; it can be one of `linkFilterIncoming`, `linkFilterOutgoing`, or `linkFilterBoth`.

### Example

This example filters on objects that have neither incoming nor outgoing links through the link module `Project Links`:

```
Module m = current
Filter f = hasNoLinks(linkFilterBoth,
                    "Project Links")

set(m, f)
filtering on
```

---

## isNull

---

### Declaration

```
Filter isNull(attribute(string attrName))
```

### Operation

Returns `true` if the call to `attribute` returns `null`.

Returns `false` if the call to `attribute` returns an attribute other than `null`.

---

## notNull

---

### Declaration

```
Filter notNull(attribute(string attrName))
```

### Operation

Returns `true` if the call to `attribute` returns an attribute other than `null`.

Returns `false` if the call to `attribute` returns `null`.



---

## reject

---

### Declaration

```
void reject(Object o)
```

### Operation

Marks object `o` as rejected under the current filter. This enables a DXL program to set an arbitrary filter on the current module. Compare with the `accept` function.

### Example

```
Object o
filtering off
// following loop only accesses displayed objects
// cycle through all displayed objects
for o in current Module do {
    bool accepted = false
    Link l
    for l in o->"*" do {
        // accept o if any out going links
        accept o
        accepted = true
        break
    }
    if (!accepted)
    {
        reject o // no outgoing links, reject o
    }
}
filtering on // activate our new filter
```

---

## set(filter)

---

### Declaration

```
void set(Module m,
         Filter f
         [,int &accepted,
          int &rejected])
```

### Operation

Applies the filter in the current module, or to module *m* where it is specified. The third and fourth parameters return the number of objects accepted and rejected respectively under the filter.

---

## stringOf(filter)

---

### Declaration

```
string stringOf(Module m,
                Filter f)
```

### Operation

Returns a string representation of filter *f* in module *m*.

---

## ancestors(show/hide)

---

### Declaration

```
void ancestors(bool show)
```

### Operation

Shows filtered object ancestors if *show* evaluates to `true`. Hides filtered object ancestors if *show* evaluates to `false`.

---

## ancestors(state)

---

### Declaration

```
bool ancestors(Module myModule)
```

### Operation

Returns `true` if filtered object ancestors are showing in the specified module. Returns `false` if filtered object ancestors are not showing in the specified module.

---

## applyFiltering

---

### Declaration

```
void applyFiltering(Module)
```

### Operation

Sets the module explorer display to reflect the current filter applied to the specified module.

---

## unApplyFiltering

---

### Declaration

```
void unApplyFiltering(Module)
```

### Operation

Switches off filtering in the module explorer for the specified module.

---

## applyingFiltering

---

### Declaration

```
bool applyingFiltering(Module)
```

### Operation

Returns a boolean indicating whether filtering is turned on in the module explorer for the specified module.

---

## Filters example program

---

```
// filter DXL example
/*
   example program building DXL filters
   can be used in Car Project "Car user reqts"
   module.
*/
// "show" sets the passed filter, refreshes
// the screen and waits for the next filter.
//
void show(Filter f, bool last, string what) {
    set f
    refresh current
}
```

```

        if (!last) what = what "\n\nready for next
                                filter?"
    ack what
}
load view "Collect reqts"    // if present
filtering on
// declare a filter
Filter f1 = attribute "Acceptability" ==
            "Acceptable"

// display it
show(f1, false, "Acceptability == Acceptable")
// a compound filter
Filter f2 = f1 && attribute "Priority" !=
            "luxury"
show(f2, false, "previous filter && Priority !=
                luxury")

Filter f3 = excludeLeaves
show(f3, true, "exclude Leaves")
filtering off

```

---

## Compound filters

Compound filters can be constructed.

### Syntax

```
Filter compound = Filter 1 operator Filter 2
                    [operator Filter 3]...
```

where:

<i>compound</i>	is a variable		
<i>operator</i>	is one of:	&&	meaning AND
			meaning OR
		!	meaning NOT
<i>1 2 3</i>	are strings		

## Operation

Combines filters to create a complex filter.

## Examples

This example filters on those objects that contain the words `shall` or `must`, regardless of case.

```
Filter required = contents("shall", false) || contents("must", false)
```

This example shows the use of the `getCompoundFilterType_` and `getComponentFilter_` filter functions. See the sections below this example for the declarations and operations of these functions.

```
Filter f1 = attribute "Object Heading" == ""
```

```
Filter f2 = contents("shall", false) || contents("must", false)
```

```
Filter f = f1 && f2
```

```
Module m = current
```

```
void decomposeFilter(Filter f, string tabStr)
```

```
{
    print tabStr "" stringOf(m, f) "\n"
    tabStr = tabStr "  "
    int ct = getCompoundFilterType_ f
    if (ct == -1)    print ""
    else if (ct == 0) print tabStr "AND\n"
    else if (ct == 1) print tabStr "OR \n"
    else if (ct == 2) print tabStr "NOT\n"
    else            print tabStr "???\n"

    int i = 0
    Filter f1 = getComponentFilter_(f, i++)
    while (!null f1)
    {
        decomposeFilter(f1, tabStr "  ")
        f1 = getComponentFilter_(f, i++)
    }
}
```

```
decomposeFilter(f, "")
```

The output is as follows:

```
(Object Heading is empty) AND ((Contains 'shall') OR (Contains 'must'))
  AND
    Object Heading is empty
      (Contains 'shall') OR (Contains 'must')
        OR
          Contains 'shall'
          Contains 'must'
```

In the special case where a user-defined attribute used in a filter has been deleted or an enumeration value used has been deleted, the filter clause will be omitted.

```
Filter f1 = attribute "theEnum" == "A"
Filter f2 = contents("shall", false) || contents("must", false)
Filter f = f1 && f2
```

When theEnum type has a value 'A', the following is output:

```
(theEnum == A) AND ((Contains 'shall') OR (Contains 'must'))
  AND
    TheEnum == A
      (Contains 'shall') OR (Contains 'must')
        OR
          Contains 'shall'
          Contains 'must'
```

If the filter is saved in a view and then the enumeration 'A' is deleted, when the view is reloaded, the output is as follows:

```
Filter f = current //i.e. the view - we cannot generate a filter with invalid
values.
```

```
((Contains 'shall') OR (Contains 'must'))
  AND
```

```
(Contains 'shall') OR (Contains 'must')
OR
```

```
Contains 'shall'
Contains 'must'
```

where the AND clause appears to have only one input.

## getCompoundFilterType\_

### Declaration

```
int getCompoundFilterType_(Filter)
```

### Operation

This perm can be used to decompose compound filters into their component parts for analysis, and potential modification or replacement.

Returns an integer value indicating the type of the specified filter.

It returns one of the following new DXL constant values for compound filter types:

```
int filterTypeAnd
```

```
int filterTypeOr
```

```
int filterTypeNot
```

It returns `-1` for a simple filter. The test for a negative value suffices to indicate that the filter is not compound, as the new constants are all positive values.

If no filter is supplied, a run-time DXL error is generated.

### Example

See examples in Compound filters above.

## GetComponentFilter\_

### Declaration

```
Filter GetComponentFilter_(Filter, int index)
```

### Operation

This perm can be used to decompose compound filters into their component parts for analysis, and potential modification or replacement.

Returns an integer value indicating the type of the specified filter.

It returns one of the following new DXL constant values for compound filter types:

```
int filterTypeAnd
```

```
int filterTypeOr
```

```
int filterTypeNot
```

This perm returns a component filter that is part of the supplied compound filter. If the compound filter is of type *filterTypeNot*, the index must be zero, or the perm returns null. If the compound filter is of type *filterTypeOr* or *filterTypeAnd*, an index of 0 or 1 returns the first or second sub-filter, and any other index value returns null.

If the supplied filter is not a compound filter, the perm returns null.

If no filter is supplied, a run-time DXL error is generated.

### Example

See examples in Compound filters above.

---

## Filtering on multi-valued attributes

This section defines the functions that can be used to filter on multi-valued attributes.

---

### includes

#### Declaration

```
Filter includes(attribute(string attrName),
               string s)
```

#### Operation

Returns the definition of a simple filter on a multi-valued attribute named *attr*, where *s* contains the filtering value.

If the attribute contains *s*, it is included in the filter set. The string *s* can only contain one value.

#### Example

This example filter set includes all objects with multi-valued attributes, one value of which is "ABC":

```
Filter f1 = includes(attribute "attribute name",
                    "ABC")
```

```
set f1
```

```
filtering on
```

---

### excludes

#### Declaration

```
Filter excludes(attribute(string attrName),
               string s)
```



## Operation

Returns the definition of a simple filter on a multi-valued attribute, where *s* contains the filtering value.

If the attribute contains *s*, it is excluded from the filter set. The string *s* can only contain one value.

## Example

This example filter set excludes all objects with multi-valued attributes, one value of which is "ABC":

```
Filter f2 = excludes(attribute "attribute name", "ABC")
set f2
filtering on
```

---

## Sorting modules

This section defines the operators and functions that allow you to sort a formal module in a similar way to the Rational DOORS user interface. These language elements use the data type `Sort`.

---

### ascending

---

#### Declaration

```
Sort ascending(string attrName)
```

#### Operation

Returns a type `Sort`, which sorts the current display with respect to the values of the object attribute named *attrName*, in ascending order.

Rational DOORS always refreshes the current module at the end of a script's execution. If a sorted display is to be viewed before that time, you must call `refresh current Module`.

#### Example

```
set ascending "Absolute Number"
sorting on
```

---

### descending

---

#### Declaration

```
Sort descending(string attrName)
```

#### Operation

Returns a type `Sort`, which sorts the current display with respect to the values of the object attribute named *attrName*, in descending order.

Rational DOORS always refreshes the current module at the end of a script's execution. If a sorted display is to be viewed before that time, you must call `refresh current Module`.

### Example

```
set descending "Absolute Number"
sorting on
```

---

## Compound sort

---

Compound sort rules can be constructed, as shown in the following syntax:

### Syntax

```
Sort compound = Sort 1 && Sort 2
```

where:

<i>compound</i>	is a variable
&&	means AND
<i>1 2</i>	are strings

### Operation

Combine a first sort with a second sort which discriminates between the objects that share the same value in the first sort.

### Example

This example sorts by the user who created the object and then by the most recently created objects:

```
Sort compound = ascending "Created By" &&
                descending "Absolute Number"

set compound
sorting on
```

---

## set(sort)

---

### Declaration

```
void set([Module m,]
        Sort s)
```

### Operation

Applies the sort rule *s* in the module specified by *m* or, if *m* is omitted, in the current module. The command `sorting on` can be used to display sorted output in the current module.

---

## sorting

---

### Declaration

```
void sorting(bool onOff)
```

### Operation

Displays sorted output in the current module.

### Example

```
set descending "Absolute Number"  
sorting on
```

---

## stringOf(sort)

---

### Declaration

```
string stringOf(Sort s)
```

### Operation

Returns a string representation of sort *s* in the current module.

---

## isAscending

---

### Declaration

```
bool isAscending(Column c)
```

### Operation

Determines whether a column *c* is sorted in ascending order. If the column is not sorted then `false` is returned.

---

## isDescending

---

### Declaration

```
bool isDescending(Column c)
```

### Operation

Determines whether a column *c* is sorted in descending order. If the column is not sorted then `false` is returned.

---

## for sort in sort

---

### Declaration

```
for s in sr do {
    ...
}
```

where

*s* is a variable of type `Sort`

*sr* is a variable of type `Sort`

### Operation

Assigns *s* to be each successive sort in a given compound sort *sr*.

### Example

This example prints all sorting information for the currently defined sort in the current module. Must be run from an open module.

```
Sort sr = current
Sort s
for s in sr do {
    print stringOf s "\n"
}
```

---

## destroySort

---

### Declaration

```
void destroySort (Module m)
```

### Operation

This perm removes any sort criteria stored with the specified module *m*

---

## Sorting example program

---

```
// sort DXL example
/*
    example program building DXL sorts
*/
Sort s1 = ascending "Absolute Number"
```

```

Sort s2 = descending "Absolute Number"
sorting on
refresh current
set s1
ack "hello"
set s2
refresh current
ack "hello"
set s1
refresh current
ack "hello"
set s2
refresh current

```

---

## Views

This section defines functions and a `for` loop for building and manipulating Rational DOORS views. Some of these elements use the `View` data type, which is a handle created for use by other functions.

If a view is to be created you must make sure that the module is in display mode.

The standard view is displayed by default. It cannot be altered or deleted, but can be loaded.

---

### currentView

---

#### Declaration

```
string currentView(Module m)
```

#### Operation

Returns the name of the view that is currently selected for the given module.

---

### descendants(show/hide)

---

#### Declaration

```
void descendants(bool expression)
```

#### Operation

Shows descendants in the module window if *expression* is true. Hides descendants if *expression* is false.

---

## descendants(state)

---

### Declaration

```
bool descendants (Module m)
```

### Operation

Returns `true` if the current *view* in module *m* is set to show descendants; otherwise returns `false`.

---

## view

---

### Declaration

```
View view([Item item,]
          string viewName)
```

### Operation

Returns a handle to a specific view in *item*, or if *item* is omitted, the current module. The *item* argument must have the value `Formal` or `Descriptive` (a formal or descriptive module). If *item* is any other value, the function returns `null`.

The view need not exist; if it does not, a new view is created but not saved until the `save (view)` function is called.

---

## delete(view)

---

### Declaration

```
string delete([Module m,] View v)
```

### Operation

Deletes the view having handle *v* from module *m*, or if *m* is omitted, from the current module. The returned string is non-NULL on error, else NULL.

### Example

```
View v = view("Basic view")
string s = delete(v)
```

---

## setPreloadedView

---

### Declaration

```
bool setPreloadedView(ViewDef view, string name)
```

## Operation

Sets the preloaded view name for the specified ViewDef *view*. Returns `true` on success, and `false` on failure. Will fail and generate a run-time DXL error if there is no current module. Will also fail if the specified *name* does not designate a view in the current module to which the current user has Read access.

Note that this perm does not check the relative access controls on the inheriting and inherited views, because the ViewDef *view* does not include access controls. These checks are made if and when the ViewDef settings are saved using the `change` or `save` perm.

## preloadedView

### Declaration

```
string preloadedView(ViewDef view)
```

### Operation

Returns the preloaded view name for the specified ViewDef *view*. Returns a null (empty) string if no preloaded view is specified for this ViewDef *view*, or if the current user does not have read access to the inherited view. Generates a run-time DXL error and returns an empty string if there is no current module.

## isinheritedView

### Declaration

```
bool isInheritedView(string viewName)
```

### Operation

This returns `true` if any view in the current module is configured to inherit settings from a view whose name matches the supplied string *viewName*, and to which the current user has read access. The user does not need to have read access to the inheriting view for this perm to return `true`. It generates a run-time DXL error and returns `false` if there is no current module.

## isValidName

See “`isValidName`,” on page 285.

## linkIndicators(show/hide)

### Declaration

```
void linkIndicators(bool show)
```

### Operation

Shows the link indicators in the current module if *show* evaluates to `true`. Hides the link indicators in the current module if *show* evaluates to `false`.

---

## linkIndicators(state)

---

### Declaration

```
bool linkIndicators(Module myModule)
```

### Operation

Returns `true` if link indicators are showing in the specified module. Returns `false` if link indicators are not showing in the specified module.

---

## load

---

### Declaration

```
bool load([Module m,] View v)
bool load(Module m, View v, bool queryUnsavedChanges)
```

### Operation

Attempts to load the view handle `v` in module `m`, or if `m` is omitted, in the current module. Supports loading the standard view. If the function fails, it returns `false`.

If the `Module` parameter is supplied, then supplying the `queryUnsavedChanges` flag is also possible. If set to `true`, and the view load will cause unsaved changes in the current view to be lost, and the users settings indicate that they wish to be informed when view changes will be lost, a confirmation query will be given to the user. The view will not be loaded if the user indicates they do not wish to lose the changes. This flag will only have an effect if the module is visible.

### Example

```
load view "cost analysis"
load view "Standard view"
```

---

## name(view)

---

### Declaration

```
string name(View view)
```

### Operation

Returns the name of `view`.

---

## next, previous(filtered)

---

### Declaration

```
Object next(Object o,
             Filter filter)
```



```
Object previous(Object o,
                Filter filter)
```

### Operation

These functions return the next or previous object at the current level of hierarchy that matches *filter*.

## clearDefaultViewForModule

### Declaration

```
string clearDefaultViewForModule (Module m)
```

### Operation

Clears the default view setting for the specified module. Returns a null string if the operation succeeds; otherwise, returns an error message.

## clearDefaultViewForUser

### Declaration

```
string clearDefaultViewForUser (Module m)
```

### Operation

Clears the default view setting, for the current user, for the specified module. Returns a null string if the operation succeeds; otherwise, returns an error message.

## getDefaultViewForModule

### Declaration

```
string getDefaultViewForModule (Module m)
```

### Operation

Returns the name of the default view for the specified module. If no default is specified, returns null.

## getDefaultViewForUser

### Declaration

```
string getDefaultViewForUser (Module m)
```

### Operation

Returns the name of the default view for the current user, for the specified module. If no default is specified for the current user, returns null.

---

## save(view)

---

### Declaration

```
void save(View v)
```

### Operation

Saves the view having handle *v* in the current module.

---

## setDefaultViewForModule

---

### Declaration

```
string setDefaultViewForModule(Module m,  
                               string viewName)
```

### Operation

Sets the default view for the specified module to *viewName*. Returns a null string if the operation succeeds; otherwise, returns an error message.

---

## setDefaultViewForUser

---

### Declaration

```
string setDefaultViewForUser(Module m,  
                              string viewName)
```

### Operation

Sets the default view, for the current user, for the specified module, to *viewName*. Returns a null string if the operation succeeds; otherwise, returns an error message.

---

## showDeletedObjects(get)

---

### Declaration

```
bool showDeletedObjects(void)
```

### Operation

Returns *true* if the current view in the current module is set to show deleted objects; otherwise returns *false*.

---

## showDeletedObjects(show/hide)

---

### Declaration

```
void showDeletedObjects (bool show)
```

### Operation

Shows deleted objects in the module window if *show* is `true`. Hides deleted objects if *show* is `false`.

---

## showChangeBars(get)

---

### Declaration

```
bool showChangeBars (Module module)
```

### Operation

Returns `true` if the specified module shows object change bars. Otherwise, returns `false`.

---

## showChangeBars(show/hide)

---

### Declaration

```
void showChangeBars (bool show)
```

### Operation

Sets the option for showing object change bars in the current module.

---

## showGraphicsDatatips(get)

---

### Declaration

```
bool showGraphicsDatatips (Module module)
```

### Operation

Returns `true` if the specified module shows datatips in Graphics Mode. Otherwise, returns `false`.

---

## showGraphicsDatatips(show/hide)

---

### Declaration

```
void showGraphicsDatatips (bool show)
```

### Operation

Sets the option for showing datatips in Graphics Mode in the current module.

---

## showGraphicsLinks(get)

---

### Declaration

```
bool showGraphicsLinks(Module module)
```

### Operation

Returns `true` if the specified module shows links in Graphics Mode. Otherwise, returns `false`.

---

## showGraphicsLinks(show/hide)

---

### Declaration

```
void showGraphicsLinks(bool show)
```

### Operation

Sets the option for showing links in Graphics Mode in the current module.

---

## showingExplorer

---

### Declaration

```
bool showingExplorer(Module module)
```

### Operation

Returns `true` if the specified module is showing the Module Explorer. Otherwise, returns `false`.

---

## showExplorer, hideExplorer

---

### Declaration

```
void showExplorer(Module module)
```

```
void hideExplorer(Module module)
```

### Operation

Sets the specified module to show or hide the Module Explorer.

---

## showPrintDialogs(get)

---

### Declaration

```
bool showPrintDialogs()
```

## Operation

Gets the current setting for displaying print dialog boxes.

Printing from the Rational DOORS user interface, rather than from DXL, automatically sets `showPrintDialogs` back to `true`.

## showPrintDialogs(set)

### Declaration

```
void showPrintDialogs (bool onOff)
```

### Operation

Sets whether print dialog boxes should be displayed when printing from DXL. This includes the printer selection dialog box, the warnings issued when printing in graphics view, or in a view that spans more than one page.

When `showPrintDialogs` is turned off, the printer selection dialog box is not displayed, so the default Windows printer, or the printer referred to in the appropriate environment variable on UNIX, is used for all printed output.

## for view in module

### Syntax

```
for s in views (Module m) do {
  ...
}
```

where:

*s* is a string variable

*m* is a module of type Module

### Operation

Assigns the string *s* to be each successive view name in the module *m*.

### Example

This example prints all views in the current module:

```
string name
for name in views current Module do
  print name "\n"
```

---

## canInheritView

---

### Declaration

```
string canInheritView(View v1, View v2, bool &b)
string canInheritView(ViewDef vd1, View v2, bool &b)
```

### Operation

The first form returns true if view *v1* can inherit settings from view *v2* in the current module according to access control restrictions. The restrictions are that every user who has read access to *v1* must also have read access to *v2*.

The second form determines whether a *ViewDef* can inherit settings from a *View*.

In both cases an error is returned on failure, or null on success.

Note that the test does not take into account group membership, so a user who is given specific access to *v1* or *vd1* and who is granted access to *v2* by virtue of group membership will not qualify *v2* as inheritable.

---

## clearInvalidInheritanceOf

---

### Declaration

```
bool clearInvalidInheritanceOf(string viewname[, ViewDef vd])
```

### Operation

This clears the `preloadView` setting of any views which currently inherit settings from the named view in the current module if that inheritance is invalid according to the access rights constraints as reflected by the `canInheritView` perm. It returns true on success and false on failure, and generates a run-time DXL error if there is no current module or if the views index file cannot be locked.

If the *defn* argument is specified, then the validity test is applied as if the named view had the access controls in the *defn* argument.

---

## invalidInheritedView

---

### Declaration

```
bool invalidInheritedView(string viewname[, ViewDef vd])
```

### Operation

This returns true if any view in the current module is configured to inherit settings from a view of the specified name to which the current user has read access, and the access control restrictions applied by `canInheritView` prohibit the inheritance relationship. The user does not have to have read access to the inheriting view. If a *ViewDef* is specified, then the restrictions are those which would apply if the view had the access rights contained within it.

---

## setViewDescription

---

### Declaration

```
void setViewDescription(ViewDef vd, string desc)
```

### Operation

Sets the description for a view where *vd* is the view definition handle.

---

## getViewDescription

---

### Declaration

```
string getViewDescription(ViewDef vd)
```

### Operation

Returns the description for a view where *vd* is the view definition handle.

---

## for View in View

---

### Syntax

```
for View1 in View2 do {
...
}
```

where:

---

<i>View1</i>	is a variable of type View
--------------	----------------------------

<i>View2</i>	is a variable of type View
--------------	----------------------------

---

### Operation

Assigns *View1* to be each successive View whose settings can be inherited by the specified *View2* according to the same access control restrictions applied by the *canInheritView* perm.

---

## View access controls

---

---

### canCreate(view)

---

#### Declaration

```
bool canCreate(ModName_ modRef, View v)
```

#### Operation

Returns `true` if the current Rational DOORS user has create access to view `v`, which can be specified as in the module `modRef`. Otherwise, returns `false`.

---

---

### canControl(view)

---

#### Declaration

```
bool canControl(ModName_ modRef, View v)
```

#### Operation

Returns `true` if the current Rational DOORS user can change the access controls on view `v`, which is specified as module `modRef`. Otherwise, returns `false`.

---

---

### canRead(view)

---

#### Declaration

```
bool canRead(ModName_ modRef, View v)
```

#### Operation

Returns `true` if the current Rational DOORS user can read view `v`, which is specified as the module `modRef`. Otherwise, returns `false`.

---

---

### canModify(view)

---

#### Declaration

```
bool canModify(ModName_ modRef, View v)
```

#### Operation

Returns `true` if the current Rational DOORS user can modify view `v`, which is specified as module `modRef`. Otherwise, returns `false`.



---

## canDelete(view)

---

### Declaration

```
bool canDelete(ModName_ modRef, View v)
```

### Operation

Returns `true` if the current Rational DOORS user can delete view `v`, which is specified as module `modRef`. Otherwise, returns `false`.

---

## canWrite(view)

---

### Declaration

```
bool canWrite(ModName_ modRef, View v)
```

### Operation

Returns `true` if the current Rational DOORS user can write view `v`, which is specified as the module `modRef`. Otherwise, returns `false`.

---

## Views example program

---

```
// view DXL example
/* construct a new view containing a selection of
   attributes. Save as the view "View DXL
   example".
*/
string viewName = "View DXL example"
DBE attrList
// contains selection of attributes to display
void buildFn(DBE dbe) {
// construct view of attributes chosen
    string attr
    Column c
    int n = 0        // number of existing columns
    int i           // column index
    for c in current Module do n++
        // count the columns
    for i in 1:n do
        delete(column 0)
        // delete n column 0s
```

```

i=0
for attr in attrList do {
    insert(column i)
    attribute(column i, attr)
    width(column i, 100)
    justify(column i, center)
    i++
}
// important! (last column does not appear
// otherwise)

refresh current
save view viewName
}
// Main program
// first look to see if we have an old view to
// display
if (load view viewName)
    ack "loaded the last constructed view for
        this example program"
else
    ack "first run of view dxl example"
DB viewDB = create "Create View"
string empty[] = {}
attrList = multiList(viewDB, "Attributes:", 5,
    empty)
button(viewDB, "Build View", buildFn)
realize viewDB
// populate attrList
string attr
for attr in current Module do
    insert(attrList, 0, attr)
show viewDB

```

---

## View definitions

This section defines functions that use the `ViewDef` data type, which holds all the settings from the Advanced tab of the Views dialog box, such as compression and outlining.

---

## create(view definition)

---

### Declaration

```
ViewDef create([Module m,
               bool allSettings])
```

### Operation

Creates a view definition in the module *m*, or if no arguments are supplied, in the current module. The *allSettings* argument specifies whether by default all of the view settings are saved.

---

## createPrivate

---

### Declaration

```
ViewDef createPrivate([Module m, bool allSettings])
```

### Operation

This new perm creates a new private module view. It saves the view with non-inherited access, giving the current user full access and everyone else no access.

---

## createPublic

---

### Declaration

```
ViewDef createPublic([Module m, bool allSettings])
```

### Operation

This new perm creates a new public module view. It saves the view with non-inherited access, giving the current user full access and everyone else Read access.

---

## get(view definition)

---

### Declaration

```
ViewDef get([Module m,]
            View v)
```

### Operation

Returns the underlying view definition in *v* for the specified module, or if *m* is omitted, for the current module.

---

## change(view definition)

---

### Declaration

```
ViewDef change(View v,
               ViewDef viewDef
               [,string viewName])
```

### Operation

Changes the underlying view definition in *v*. Optionally, changes the name of the view.

---

## delete(view definition)

---

### Declaration

```
void delete(ViewDef viewDef)
```

### Operation

Deletes the view definition *viewDef* from the current module. The returned string is non-NULL on error, else NULL.

### Example

```
View v = view("Basic View")
ViewDef vdef = get(v)
string s = delete(current Module, v)
```

---

## save(view definition)

---

### Declaration

```
void save([Module m,]
          View v,
          ViewDef viewDef)
```

### Operation

Saves the view definition *viewDef* into view *v* in module *m*, or if *m* is omitted, in the current module.

---

## useAncestors(get and set)

---

### Declaration

```
bool useAncestors(ViewDef viewDef)
void useAncestors(ViewDef viewDef,
                  bool save)
```

## Operation

The first form returns `true` if the option to save the advanced filter option for showing ancestors is currently set. Otherwise, returns `false`.

The second form sets the option to save the advanced filter option for showing ancestors.

If the option for showing ancestors is set, a filtered view contains objects that match the given filter and that object's parent hierarchy too.

## useDescendants(get and set)

### Declaration

```
bool useDescendants(ViewDef viewDef)
void useDescendants(ViewDef viewDef,
                  bool save)
```

### Operation

The first form returns `true` if the option to save the advanced filter option for showing descendants is currently set. Otherwise, returns `false`.

The second form sets the option to save the advanced filter option for showing descendants.

If the option to show descendants is set, a filtered view contains objects that match the given filter and that object's child hierarchy too.

## useCurrent(get and set)

### Declaration

```
bool useCurrent(ViewDef viewDef)
void useCurrent(ViewDef viewDef,
                bool save)
```

### Operation

The first form returns `true` if the option to save information about the currently selected object is currently set. Otherwise, returns `false`.

The second form sets the option to save information about the currently selected object.

## useSelection(get and set)

### Declaration

```
bool useSelection(ViewDef viewDef)
void useSelection(ViewDef viewDef,
                  bool save)
```

## Operation

The first form returns `true` if the option to save information about currently selected objects is currently set. Otherwise, returns `false`.

The second form sets the option to save information about currently selected objects.

## useColumns(get and set)

### Declaration

```
bool useColumns(ViewDef viewDef)
void useColumns(ViewDef viewDef,
                bool save)
```

### Operation

The first form returns `true` if the option to save column information is currently set. Otherwise, returns `false`.

The second form sets the option to save column information.

## useFilterTables(get and set)

### Declaration

```
bool useFilterTables(ViewDef viewDef)
void useFilterTables(ViewDef viewDef,
                    bool save)
```

### Operation

The first form returns `true` if the option to save the advanced filter option for hiding non-matching table cells is currently set. Otherwise, returns `false`.

The second form sets the option to save the advanced filter option for hiding non-matching table cells.

## useGraphicsColumn(get and set)

### Declaration

```
bool useGraphicsColumn(ViewDef viewDef)
void useGraphicsColumn(ViewDef viewDef,
                      bool save)
```

### Operation

The first form returns `true` if the option to save information about which column's values are displayed in the object boxes when in Graphics Mode is currently set. Otherwise, returns `false`.

The second form sets the option to save information about which column's values are displayed in the object boxes when in Graphics Mode.

---

## useShowExplorer(get and set)

---

### Declaration

```
bool useShowExplorer(ViewDef viewDef)
void useShowExplorer(ViewDef viewDef,
                     bool save)
```

### Operation

The first form returns `true` if the option to save the **Module Explorer** setting (shown on the **View** menu) is currently set. Otherwise, returns `false`.

The second form sets the option to save the **Module Explorer** setting.

---

## useGraphics(get and set)

---

### Declaration

```
bool useGraphics(ViewDef viewDef)
void useGraphics(ViewDef viewDef,
                 bool save)
```

### Operation

The first form returns `true` if the option to save the **Graphics Mode** setting (shown on the **View** menu) is currently set. Otherwise, returns `false`.

The second form sets the option to save the **Graphics Mode** setting.

---

## useOutlining(get and set)

---

### Declaration

```
bool useOutlining(ViewDef viewDef)
void useOutlining(ViewDef viewDef,
                  bool save)
```

### Operation

The first form returns `true` if the option to save the **Outline** setting (shown on the **View** menu) is currently set. Otherwise, returns `false`.

The second form sets the option to save the **Outline** setting.

---

## useCompression(get and set)

---

### Declaration

```
bool useCompression(ViewDef viewDef)
void useCompression(ViewDef viewDef,
                    bool save)
```

### Operation

The first form returns `true` if the option to save the **Compress** setting (shown on the **View** menu) is currently set. Otherwise, returns `false`.

The second form sets the option to save the **Compress** setting.

---

## useLevel(get and set)

---

### Declaration

```
bool useLevel(ViewDef viewDef)
void useLevel(ViewDef viewDef,
              bool save)
```

### Operation

The first form returns `true` if the option to save the **Level** setting (shown on the **View** menu) is currently set. Otherwise, returns `false`.

The second form sets the option to save the **Level** setting.

---

## useSorting(get and set)

---

### Declaration

```
bool useSorting(ViewDef viewDef)
void useSorting(ViewDef viewDef,
                bool save)
```

### Operation

The first form returns `true` if the option to save the **Sort** setting (shown on the **View > Show** menu) is currently set. Otherwise, returns `false`.

The second form sets the option to save the **Sort** setting.



---

## useFiltering(get and set)

---

### Declaration

```
bool useFiltering(ViewDef viewDef)
void useFiltering(ViewDef viewDef,
                  bool save)
```

### Operation

The first form returns `true` if the option to save the **Filter** setting (shown on the **View > Show** menu) is currently set. Otherwise, returns `false`.

The second form sets the option to save the **Filter** setting.

---

## useShowDeleted(get and set)

---

### Declaration

```
bool useShowDeleted(ViewDef viewDef)
void useShowDeleted(ViewDef viewDef,
                    bool save)
```

### Operation

The first form returns `true` if the option to save the **Deletions** setting (shown on the **View > Show** menu) is currently set. Otherwise, returns `false`.

The second form sets the option to save the **Deletions** setting.

---

## useShowPictures(get and set)

---

### Declaration

```
bool useShowPictures(ViewDef viewDef)
void useShowPictures(ViewDef viewDef,
                    bool save)
```

### Operation

The first form returns `true` if the option to save the **Pictures** setting (shown on the **View > Show** menu) is currently set. Otherwise, returns `false`.

The second form sets the option to save the **Pictures** setting.

---

## useShowTables(get and set)

---

### Declaration

```
bool useShowTables (ViewDef viewDef)
void useShowTables (ViewDef viewDef,
                   bool save)
```

### Operation

The first form returns `true` if the option to save the **Table Cells** setting (shown on the **View > Show** menu) is currently set. Otherwise, returns **false**.

The second form sets the option to save the **Table Cells** setting.

---

## useShowLinkIndicators(get and set)

---

### Declaration

```
bool useShowLinkIndicators (ViewDef viewDef)
void useShowLinkIndicators (ViewDef viewDef,
                           bool save)
```

### Operation

The first form returns `true` if the option to save the **Link Arrows** setting (shown on the **View > Show** menu) is currently set. Otherwise, returns `false`.

The second form sets the option to save the **Link Arrows** setting.

---

## useShowLinks(get and set)

---

### Declaration

```
bool useShowLinks (ViewDef viewDef)
void useShowLinks (ViewDef viewDef,
                  bool save)
```

### Operation

The first form returns `true` if the option to save the **Graphics Links** setting (shown on the **View > Show** menu) is currently set. Otherwise, returns `false`.

The second form sets the option to save the **Graphics Links** setting.

---

## useTooltipColumn(get and set)

---

### Declaration

```
bool useTooltipColumn(ViewDef viewDef)
void useTooltipColumn(ViewDef viewDef,
                      bool save)
```

### Operation

The first form returns `true` if the option to save the **Graphics Datatips** setting (shown on the **View > Show** menu) is currently set. Otherwise, returns `false`.

The second form sets the option to save the **Graphics Datatips** setting.

---

## useWindows(get and set)

---

### Declaration

```
bool useWindows(ViewDef viewDef)
void useWindows(ViewDef viewDef,
                bool save)
```

### Operation

The first form returns `true` if the option to save the current window size and position is currently set. Otherwise, returns `false`.

The second form sets the option to save the current window size and position.

If a view is saved in batch mode with the option to save the current window size and position set to `true`, the view will be saved with a module window that is not visible.

---

## useAutoIndentation

---

### Declaration

```
void useAutoIndentation(ViewDef vDef, Bool)
bool useAutoIndentation(ViewDef vDef)
```

### Operation

The first form sets the auto-indentation status of the supplied `ViewDef` (this equates to the setting of the “Indentation of main column” check box on the advanced tab of the “Manage Views” dialog).

The second form returns the auto-indentation status of the supplied `ViewDef`.

### Example

```
ViewDef viewInfo = get(view "viewName")
```

```
print useAutoIndentation(viewInfo)
```

---

## Columns

This section defines functions and a `for` loop for building and manipulating Rational DOORS columns. These elements use the data types `Column` and `Justification`.

**Note:** The data type `Justification` is used for constants specifying text alignment.

---

### column

---

#### Declaration

```
Column column([Module m, ]
              int n)
```

#### Operation

Returns a handle on the  $n$ th column, starting from 0, in module  $m$ , or if  $m$  is omitted, in the current module. The handle is used in other column functions.

---

### Column alignment constants

---

The following constants of type `Justification` are defined for reading or setting the alignment of text in a column.

<code>left</code>	aligns text to the left column
<code>right</code>	aligns text to the right column
<code>center</code>	centers text
<code>centre</code>	centers text
<code>full</code>	justifies text

---

### attribute(in column)

---

#### Declaration

```
void attribute(Column c,
              string attr)
```

#### Operation

Makes column  $c$  display the attribute  $attr$ .

---

## attrName

---

### Declaration

```
string attrName(Column c)
```

### Operation

Returns the name of the attribute displayed in a column; this is the value that the `attribute(in column)` function sets. Returns `null` if the column does not display an attribute.

### Example

This example prints out the names of all the attributes displayed in the current view:

```
Module m = current
Column c
for c in m do {
    print "<" (attrName c) ">\n"
}
```

---

## color(get)

---

### Declaration

```
string colo[u]r(Column c)
```

### Operation

Returns the name of the attribute used for coloring a column, or `null` if none is set.

---

## color(set)

---

### Declaration

```
void colo[u]r(Column c,
                string attrName)
```

### Operation

Uses `color` on column `c` as specified by the attribute named `attrName`.

---

## backgroundColor(get)

---

### Declaration

```
string backgroundColo[u]r(Column c)
```

## Operation

Returns the name of the attribute that is used to color the background in column *c*, or null if none is set.

## backgroundColor(set)

### Declaration

```
void backgroundColor(Column c, string enumAttrName)
```

### Operation

Sets the attribute *enumAttrName* as the background color for column *c*.

### Example

```
Column c = column(1)
```

```
backgroundColor(c, "enumAttrName")
```

Sets the background color for column *c* to use attribute *enumAttrName*.

```
Column c = column(1)
```

```
backgroundColor(c, "")
```

Removes any previously configured background color attribute for column *c*.

## delete(column)

### Declaration

```
void delete(Column c)
```

### Operation

Deletes column *c*. This command should not be used inside the column `for . . do` loop. If every column must be deleted, use the following example.

### Example

```
int n = 0          // number of existing columns
```

```
int i             // column index
```

```
Column c
```

```
for c in current Module do
    n++ // count the columns
```

```
// delete n column 0s
```

```
for i in 1:n do {
    delete column 0
}
```

---

## dxl(get)

---

### Declaration

```
string dxl(Column c)
```

### Operation

Returns the DXL code set for DXL column *c*.

### Example

Column *col*

```
for col in current Module do {
    string att = attrName(col)

    if (null att) {
        if (main(col)) {
            print "main\t"
        } else {
            print dxl(col) "\t"
        }
    } else {
        print att "\t"
    }
}
```

---

## dxl(set)

---

### Declaration

```
void dxl(Column c,
          string dxlCode)
```

### Operation

Sets the DXL code to use in a DXL column. This is equivalent to the menu option **Column > Edit > dxl**.

If you wish to use a Windows-style file separator (\), you must duplicate it (\\) so that DXL does not interpret it as a meta character in the string. Because Rational DOORS automatically converts UNIX-style file separators (/) for Windows, it is usually more convenient to use them.

### Example

```
dxl(column 0, "display obj.\"Object Heading\"")
dxl(column 1, "#include <layout/trace.dxl>")
```

---

**graphics(get)**

---

**Declaration**

```
bool graphics(Column c)
```

**Operation**

Returns `true` when `c` is the column nominated for viewing in a graphics display; otherwise, returns `false`.

---

**graphics(set)**

---

**Declaration**

```
void graphics(Column c)
```

**Operation**

Nominates the column for viewing in a graphics display.

---

**info(get)**

---

**Declaration**

```
bool info(Column c)
```

**Operation**

Returns `true` when `c` is the column nominated for use by the datatips mechanism in Graphics mode; otherwise, returns `false`.

---

**info(set)**

---

**Declaration**

```
void info(Column c)
```

**Operation**

Nominates the column for use by the datatips mechanism in Graphics mode.

---

**insert(column in module)**

---

**Declaration**

```
Column insert(Column c)
```



## Operation

Inserts a column, pushing subsequent columns one right. Returns a handle to the new column. If a column is inserted at a new position, it is important to initialize the width of the new column (see the `width (get)` function).

## Example

This example inserts a new column 1 as a copy of the old column 1, if present:

```
insert(column 1)
```

## justify(get alignment)

### Declaration

```
string justify(Column c)
Justification justify(Column c)
```

### Operation

The first form returns a string version of the type `Justification` constants.

The second form returns the type `Justification` constant for the specified column `c`. The constants are defined in “Column alignment constants,” on page 686.

## justify(set alignment)

### Declaration

```
void justify(Column c,
              Justification j)
```

### Operation

Sets the alignment or justification of column `c` to the `Justification` constant `j`, which can be one of the constants defined in “Column alignment constants,” on page 686.

### Example

```
justify(column 1, center)
```

## main(get)

### Declaration

```
bool main(Column c)
```

### Operation

Returns `true` if the column is the main text column (with the appearance of the second column in the standard view).

---

## main(set)

---

### Declaration

```
void main(Column c)
```

### Operation

Makes column *c* the main text column (with the appearance of the second column in the standard view).

---

## link(get)

---

### Declaration

```
bool link(Column c)
```

### Operation

Returns true if column *c* is a link indicator column.

---

## link(set)

---

### Declaration

```
void link(Column c)
```

### Operation

Makes column *c* a link indicator column.

---

## changebar(get)

---

### Declaration

```
bool changebar(Column c)
```

### Operation

Returns true if column *c* is a change bar column.

---

## changebar(set)

---

### Declaration

```
void changebar(Column c)
```

### Operation

Makes column *c* a change bar column.

---

## text(column)

---

### Declaration

```
string text(Column c,
            Object o)
```

### Operation

Returns the text contained in column *c* for object *o*.

When *c* is the main column, this function returns the empty string. You must assemble the elements of the main column from the "Object Heading" and "Object Text" attributes, and the number function. You can use the main (get) function to check for this condition.

### Example

```
Object o
Column c
for o in current Module do {
  for c in current Module do {
    if (main c) {
      print o."Object Heading" "\n\n"
      print o."Object Text" "\n\n"
    } else {
      print text(c, o) "\n"
    }
  }
}
```

---

## title(get)

---

### Declaration

```
string title(Column c)
```

### Operation

Returns the string that is the title of column *c*.

---

## title(set)

---

### Declaration

```
void title(Column c,
           string heading)
```

### Operation

Sets the title of column *c* to the string *heading*.

---

## width(get)

---

### Declaration

```
int width(Column c)
```

### Operation

Returns the number of screen pixels used by column *c*.

### Example

```
Column c
for c in current Module do {
    print (title c) " " (justify c) " "
    print (width c) "\n"
}
```

---

## width(set)

---

### Declaration

```
void width(Column c,
            int w)
```

### Operation

Sets the width of column *c* to *w* in pixels.

---

## currentColumn(get)

---

### Declaration

```
Column currentColumn(void)
```

### Operation

Gets the current column for this DXL context. If the DXL is not layout DXL, then this will return NULL.

### Example

```
string name = ?attributeName?;
Column c = currentColumn()

if (null c)
{
    // Attribute DXL
```

```

        obj.attrDXLName = name;
    }
else
{
    // Layout DXL
    display(name);
}

```

---

## for columns in module

---

### Syntax

```

for c in m do {
    ...
}

```

where:

*c* is a variable of type Column  
*m* is a module of type Module

### Operation

Assigns the variable *c* to be each successive column in the current view in module *m*. The command `delete (Column)` should not be used inside the body of the loop.

### Example

```

Column c
for c in current Module do print (title c) "\n"

```

---

## Scrolling functions

This section gives the syntax for scrolling functions, which control view scrolling. The functions use internal data types, so declarations are not stated.

---

### scroll

---

#### Syntax

```

scroll(position)

```

## Operation

Scrolls to the position determined by the supporting functions: `top`, `bottom`, `to`, `up`, `down`, and `page`. The syntax for these functions is as follows:

```
top (Module m)
bottom (Module m)
to ({top|bottom} (Module m))
to (Object o)
up (Module m)
down (Module m)
page ({up|down} (Module m))
```

## Example

```
scroll up current Module
scroll down current Module
scroll page up current Module
scroll page down current Module
```

---

# Layout DXL

This section describes the DXL features unique to layout DXL. Layout DXL is used to populate a column within a Rational DOORS view, typically to construct traceability or impact analysis reports.

The Insert Column dialog box in the Rational DOORS user interface has a **Layout DXL** option which pops up a DXL Library window, which enables you to browse several layout DXL programs; they can also be found in `$DOORSHOME/lib/dxl/layout`.

For information on how to check the validity of your DXL code, see the `checkDXL` function.

---

## Layout context

Layout DXL programs run in a context where the variable `obj` is pre-declared. You can have a column that contains DXL code. The code calculates the value to display for each object. The current object to calculate is referred to as `obj`.

---

## display

### Declaration

```
void display(string line)
void display(attrRef)
```

where *attrRef* is in one of the following formats:

```
(Object o).(string attrName)
(Module m).(string attrName)
(Link l).(string attrName)
```

## Operation

Adds a new line to the column. The new line contains the specified string or the value of the referenced attribute.

If you pass a referenced attribute and the value contains rich text markup, this function interprets the rich text markup.

If you pass a string that contains rich text markup, this function does not interpret the rich text markup; it passes the rich text tags as text characters. Use the `displayRich` function if you want the rich text markup to be interpreted.

For more information, see “Rich text,” on page 829.

## Example

This example takes two attribute values from the current object `obj` and calculates a derived value for display. The empty string is needed to convert the area’s `int` value into a string:

```
// calculate area of obj
int length = obj."Length"
int width = obj."Width"
display (length*width) ""
```

This example adds another line to the column with the attribute "Object Text":

```
display obj."Object Text"
```

This example is for a module where column A is text and column B is the following DXL:

```
string s=obj."A" ""
display "<"s s">"
```

For values of A of hello and bye, you see:

```
Column: ID A (text) B (DXL)
Values: 1 hello <hellohello>
       2 bye <byebye>
```

---

## displayRich

---

### Declaration

```
void displayRich(string richTextString)
```

### Operation

Adds a new line containing the specified string to the column followed by a trailing blank line.

This function operates in the same way as the `display` function, except that it interprets any rich text markup in the specified string. For more information, see “Rich text,” on page 829.

## Example

```
displayRich richText obj."Object Text"
```

## displayRichWithColo[u]r

### Declaration

```
void displayRichWithColo[u]r(string richTextString)
```

### Operation

Like the existing `displayRich` for displaying text in layout dxl, but respects the text color specified in the string argument, which must be RTF (not plain text).

### Example

```
bool fullRTF=true
Buffer b1=create
Buffer b2=create
Buffer res=create

b1=obj."Specification"
b2=obj."Proposed_specification"

diff(res, b1, b2, fullRTF)
displayRichWithColour stringOf(res)
```

## getCanvas

### Declaration

```
DBE getCanvas()
```

### Operation

Returns a handle to a virtual canvas with which normal canvas drawing functions can be used. The canvas is in the Rational DOORS formal module `display` in a column driven by layout DXL. When using this perm, checks should be made for the perm returning a null value, to prevent DXL errors.

## hasPicture/exportPicture

### Declaration

```
bool hasPicture(Column c)
```



```
string exportPicture(Column c, Object o, string filename, int format)
```

## Operation

The two perms here are for use along with the `htmlText` perm. After calling `htmlText` on a column, `hasPicture` will tell you whether a picture of some layout DXL has been stored with the column. You can then call `exportPicture` to export the picture.

## isFirstObjectInDXLSet(Object)

### Declaration

```
bool isFirstObjectInDXLSet(Object o)
```

### Operation

This perm has been added for use only within layout DXL.

Exposes to DXL the processing of objects during various stages of the execution of layout DXL.

Layout DXL processes sets of objects at a time. When layout DXL is running against an object, that object might be in a set of objects that will be processed. For example, during the repaint of a formal module display, the set is those objects that will be drawn to the display.

This perm returns `true` in the following cases:

- Layout DXL is not executing
- Layout DXL is executing against a set of objects, and `Object` is the first to be processed in that set

An object may be simultaneously the first such object in a set and also the last such object in a set; the set might contain a single object.

This perm, and its partner, `isLastObjectInDXLSet()`, allow layout DXL to perform certain actions only at the start or end of a particular set processing. This can support the DXL programmer to write more efficient layout DXL.

## isLastObjectInDXLSet(Object)

### Declaration

```
bool isLastObjectInDXLSet(Object o)
```

### Operation

This perm has been added for use only within layout DXL.

Exposes to DXL the processing of objects during various stages of the execution of layout DXL.

Layout DXL processes sets of objects at a time. When layout DXL is running against an object, that object might be in a set of objects that will be processed. For example, during the repaint of a formal module display, the set is those objects that will be drawn to the display.

This perm returns `true` in the following cases:

- layout DXL is not executing
- layout DXL is executing against a set of objects, and `Object` is the last to be processed in that set

An object may be simultaneously the first such object in a set and also the last such object in a set; the set might be singleton.

This perm, and its partner, `isFirstObjectInDXLSet()`, allow layout DXL to perform certain actions only at the start or end of a particular set processing. This can support the DXL programmer to write more efficient layout DXL.

## Example

Insert a Layout DXL column containing the following:

```
if (isFirstObjectInDXLSet(obj))
{
    display "This is the first object in the module window."
}
else if (isLastObjectInDXLSet(obj))
{
    display "This is the last object in the module window."
}
else
{
    // do nothing
}
```

You can then click your mouse on the bottom right hand corner of the module window and resize to see the perms in operation.

---

## setRefreshDelta

---

### Declaration

```
setRefreshDelta(Column c, int delta)
```

### Operation

Identifies the column in the view that contains the Layout DXL function. This function also specifies the refresh interval in seconds for the displayed values.

### Example

In this example, the Layout DXL column is the third column in the view. The column numbering begins with 0, so the value of the third column is 2.

```
Column c
c = column(2) //third column in view
setRefreshDelta(c, 100)
```

## Chapter 26

# Partitions

This chapter provides information on Rational DOORS partitions.

- Partition concepts
- Partition definition management
- Partition definition contents
- Partition management
- Partition information
- Partition access

---

## Partition concepts

Any partition operation can be performed through DXL. These operations fall into the following categories:

- Management of partition definitions
- Management of partitions
  - Exporting a partition from the home database
  - Accepting a partition in the away database
  - Adding data to a partition in the away database
  - Returning a partition from the away database
  - Rejoining a partition to the home database

---

## Partition definition management

A partition definition describes the information that is to be included in partition. This is a list of modules, called partition modules, and, for each partition module, a list of attributes, views, and (for link modules) linksets to be included. A partition module is really just a placeholder for the real module, but it is associated with a real module. This manual refers to it as if it were the regular module.

In a partition definition, a set of maximum access rights is associated with each partition module, partition attribute, and partition view. These maximum access rights determine what users at the away database can do when the partition definition is used to create a partition.

---

## create(partition definition)

---

### Declaration

```
PartitionDefinition create(Project p,  
                           string name,  
                           string desc)
```

### Operation

Creates a partition definition in project *p* with name *name* and description *desc*. The partition definition created must be saved before use.

---

## delete(partition definition)

---

### Declaration

```
string delete(PartitionDefinition pd)
```

### Operation

Removes the partition definition *pd* from its project.

If successful, returns a null string; otherwise returns a string containing an error message.

---

## dispose(partition definition)

---

### Declaration

```
string dispose(PartitionDefinition pd)
```

### Operation

Frees up the memory used by DXL to store the partition definition *pd*. It does not affect the partition definition as stored in the database.

If successful, returns a null string; otherwise returns a string containing an error message.

---

## copy(partition definition)

---

### Declaration

```
string copy(PartitionDefinition pd,  
            string name,  
            string desc)
```

### Operation

Creates a copy of a partition definition with the name *name*, and the description *desc*.

If successful, returns a null string; otherwise returns a string containing an error message.

---

## rename(partition definition)

---

### Declaration

```
string rename(PartitionDefinition pd,
              string newName)
```

### Operation

Changes the name of a partition definition to *newName*.

If successful, returns a null string; otherwise returns a string containing an error message.

---

## load(partition definition)

---

### Declaration

```
PartitionDefinition load(Project p,
                        string name)
```

### Operation

Loads partition definition *name* in project *p*. This is used to obtain a handle for editing with the `addModule`, `addLinkModule`, and `removeModule` functions, but not the `addAwayModule`, `addAwayLinkModule` functions.

---

## loadInPartitionDef

---

### Declaration

```
PartitionDefinition
loadInPartitionDef(Project p, string name)
```

### Operation

Loads partition definition associated with the partition *name*, which is a partition that has been accepted into project *p*. This is used in the away database to add data to a partition with the `addAwayModule`, `addAwayLinkModule` functions.

---

## save(partition definition)

---

### Declaration

```
string save(PartitionDefinition pd)
```

### Operation

Saves a partition definition in the home database.

If successful, returns a null string; otherwise returns a string containing an error message.

---

## saveModified(partition definition)

---

### Declaration

```
string saveModified(Project p,
                   string inPartname
                   PartitionDefinition pd)
```

### Operation

Saves a partition definition in the away database. The partition definition is associated with the partition *inPartname*, which has been accepted into the away database.

If successful, returns a null string; otherwise returns a string containing an error message.

### Example

```
pd = loadInPartitionDef(project, "N")
(...)
saveModified(project, "N", pd)
```

---

## setDescription(partition definition)

---

### Declaration

```
string setDescription(PartitionDefinition pd,
                     string newDesc)
```

### Operation

Changes the description of a partition definition to *newDesc*.

If successful, returns a null string; otherwise returns a string containing an error message.

---

## Partition definition contents

This section describes functions and `for` loops concerned with the contents of a partition definition.

---

## addModule, addLinkModule

---

### Declaration

```
string add[Link]Module(PartitionDefinition pd,
                      string modName)
```

## Operation

Adds module *modName* to the partition definition *pd*. The module name must be specified with a full path name relative to the project (beginning with the project name).

If successful, returns a null string; otherwise returns a string containing an error message.

Use the function `addModule` for formal modules; use `addLinkModule` for link modules.

These perms will add the module to the partition definition with access rights set to RMCD by default.

## addAwayModule, addAwayLinkModule

### Declaration

```
string
addAway[Link]Module(PartitionDefinition pd,
                    string modName)
```

### Operation

Adds module *modName* to the partition definition *pd* in the away database. This means that *pd* must be obtained from the `loadInPartitionDef` function. The module name must be specified relative to the folder in the away database created when the partition was accepted.

If successful, returns a null string; otherwise returns a string containing an error message.

Use the function `addAwayModule` for formal modules; use `addAwayLinkModule` for link modules.

This marks the module as being partitioned in. When the partition is finally returned, the module is returned with the other partitioned-in data.

### Example

If you accept a partition called N into a folder B, a folder called N is created inside B. If you then create a module A in folder N, you can add it to the partition definition with:

```
pd = loadInPartitionDef(project, "N")
addAwayModule(pd, "A")
```

## findModule

### Declaration

```
PartitionModule
findModule(PartitionDefinition pd,
           string modName)
```

### Operation

Returns a handle to the description of the module in the partition definition *pd*. In the home database, the *modName* argument must be an absolute path from the containing project (not including the project name). In the away database, the *modName* argument must be a path relative to the partition folder.

The handle is used with the `findLinkset`, `addLinkset`, `addAwayLinkset`, and `addView`, `addAwayView` functions to edit the information, including linksets, associated with this module in the partition definition.

---

## findLinkset

---

### Declaration

```
PartitionLinkset findLinkset(PartitionModule pm,
                             string source,
                             string target)
```

### Operation

Returns a handle for the linkset between `source` and `target` in the partitioned link module `pm`. The names specified for both the source and target modules must be absolute paths from the containing project (not including the project name).

---

## findAttribute

---

### Declaration

```
PartitionAttribute
findAttribute(PartitionModule pm,
              string attrName)
```

### Operation

Returns a handle for the attribute called `attrName` in the partition module `pm`.

The handle can be used with dot notation to extract the name of the attribute.

---

## findView

---

### Declaration

```
PartitionView findView(PartitionModule pm,
                       string viewName)
```

### Operation

Returns a handle for the view called `viewName` in the partition module `pm`.

The handle can be used with dot notation to extract the name of the view.

---

## addAttribute, addAwayAttribute

---

### Declaration

```
string add[Away]Attribute(PartitionModule pm,
                          string attrName)
```



## Operation

Specifies that attribute *attrName* is to be included with the information in partition module *pm*. Use the function `addAwayAttribute` when adding information in the away database.

If successful, returns a null string; otherwise returns a string containing an error message.

## addLinkset, addAwayLinkset

### Declaration

```
string add[Away]Linkset(PartitionModule pm,
                       string srcName,
                       string trgName)
```

### Operation

Adds a linkset to a partition definition containing *pm*, which must be a link module in the partition definition. The linkset has source *srcName* and target *trgName* in module *pm*.

Use the `addAwayLinkset` function when adding information in the away database.

For `addLinkset`, the names specified for both the source and target modules must be absolute paths from the containing project (not including the project name).

For `addAwayLinkset` the module name must be specified relative to the folder in the away database created when the partition was accepted.

If successful, returns a null string; otherwise returns a string containing an error message.

## addView, addAwayView

### Declaration

```
string add[Away]View(PartitionModule pm,
                    string viewName)
```

### Operation

Specifies that view *viewName* is to be included with the information in partition module *pm*, which must describe a formal module. Use the function `addAwayView` when adding information in the away database.

If successful, returns a null string; otherwise returns a string containing an error message.

## removeModule

### Declaration

```
string removeModule(PartitionDefinition pd,
                   string modName)
```

## Operation

Removes a partition module from a partition definition.

If successful, returns a null string; otherwise returns a string containing an error message.

## removeAttribute

### Declaration

```
string removeAttribute(PartitionModule pm,
                      string attrName)
```

### Operation

Removes attribute *attrName* from the information to be included with partition module *pm*. You cannot remove information from a partition definition in the away database.

If successful, returns a null string; otherwise returns a string containing an error message.

## removeLinkset

### Declaration

```
PartitionLinkset
removeLinkset(PartitionModule pm,
              string source,
              string target)
```

### Operation

Removes a particular linkset from the information to be included with partition module *pm*, which must be a link module. The names specified for both the source and target modules must be absolute paths from the containing project (not including the project name).

## removeView

### Declaration

```
string removeView(PartitionModule pm,
                  string viewName)
```

### Operation

Removes view *viewName* from the information to be included with partition module *pm*. You cannot remove information from a partition definition in the away database.

If successful, returns a null string; otherwise returns a string containing an error message.

---

## allowsAccess

---

### Declaration

```
bool
allowsAccess({PartitionAttribute pa|
              PartitionModule pm|
              PartitionView pv},
              PartitionPermission pp)
```

### Operation

Returns `true` if the data is to be included in the partition with the maximum access rights `pp`. Otherwise, returns `false`.

---

## setAccess

---

### Declaration

```
void setAccess({PartitionAttribute pa|
               PartitionModule pm|
               PartitionView pv},
               PartitionPermission pp)
```

### Operation

Sets the maximum access rights to the data in the way database to be `pp`.

---

## for partition module in partition definition

---

### Syntax

```
for partModule in partDefinition do {
  ...
}
```

where:

<i>partModule</i>	is a variable of type <code>PartitionModule</code>
<i>partDefinition</i>	is a variable of type <code>PartitionDefinition</code>

### Operation

Assigns *partModule* to be each successive module within *partDefinition*.

---

## for partition attribute in partition module

---

### Syntax

```
for partAttr in partModule do {  
  ...  
}
```

where:

*partAttr* is a variable of type `PartitionAttribute`

*partModule* is a variable of type `PartitionModule`

### Operation

Assigns *partAttr* to be each successive attribute within *partModule*.

---

## for partition view in partition module

---

### Syntax

```
for partView in partModule do {  
  ...  
}
```

where:

*partView* is a variable of type `PartitionView`

*partModule* is a variable of type `PartitionModule`

### Operation

Assigns *partView* to be each successive view within *partModule*.

---

## Partition management

This section describes the functions for exporting, accepting, returning, and rejoining partitions.

---

## apply(partition definition)

---

### Declaration

```
string apply(Project p,
             string partDefName,
             string partName,
             string partDesc,
             string filename[, bool overwrite])
```

### Operation

Applies partition definition *partDefName* to create a partition with name *partName* and description *partDesc*. The partition is written to file *filename*, which should have a file type of `.par`. Note that the same partition definition can be used on different occasions to create partitions with different names. If the boolean argument *overwrite* is specified as `true`, and the specified export file already exists, it will be overwritten. If the argument is `false`, or is not given, then the perm will not overwrite the file, but will return an error message.

---

## open(partition file)

---

### Declaration

```
PartitionFile open(string filename)
```

### Operation

Creates a partition file and returns a handle. The file type must be `.par`.

The handle can be used with dot notation to extract any of the properties available from a variable of type `PartitionFile`.

### Example

This example checks that the file is a valid partition file:

```
PartitionFile pf = open("partition.par")
```

---

## close(partition file)

---

### Declaration

```
string close(PartitionFile pf)
```

### Operation

Closes a partition file and releases the handle.

If successful, returns a null string; otherwise returns a string containing an error message.

---

## acceptReport

---

### Declaration

```
string acceptReport(PartitionFile pf,
                   string foldername)
```

### Operation

Returns a string containing a report on information that would be produced if the partition in *pf* is accepted into folder *foldername*. This includes the names of the modules, attributes, and views which would be created.

---

## acceptPartition

---

### Declaration

```
string acceptPartition(Project p,
                      PartitionFile pf,
                      folder foldername)
```

### Operation

Accepts the partition in *pf* into folder *foldername* in project *p*.

If successful, returns a null string; otherwise returns a string containing an error message.

---

## returnPartition

---

### Declaration

```
string returnPartition(Project p,
                      string partName,
                      string returnDesc,
                      string partFileName,
                      bool isFinal,
                      bool deleteData[, bool overwrite])
```

### Operation

Returns the accepted partition with name *partName*, using the description *returnDesc*. This creates file *partFileName*.

If *isFinal* is true, the return is a final return: the data cannot be returned again. If *isFinal* is false, the return is a synchronize operation, and the value of *deleteData* is ignored.

If *deleteData* is true, the return operation deletes all accepted data. If *deleteData* is false, the return operation removes partition locks on the data, so that it remains in the database but is no longer partitioned in.

If the argument *overwrite* is specified as true, and the specified file already exists, it will be overwritten. If the argument is false, or is not given, then the perm will not overwrite the file, but will return an error message.

If successful, returns a null string; otherwise returns a string containing an error message.

---

---

## rejoinReport

---

### Declaration

```
string rejoinReport(PartitionFile pf,
                   string pathname)
```

### Operation

Returns a string containing a report on information that would be produced if the partition in *pf* is rejoined. This includes the names of the modules, attributes, and views which would be created. The *pathname* argument is reserved for future enhancements; currently, it is ignored.

---

## rejoinPartition

---

### Declaration

```
string rejoinPartition(Project p,
                      PartitionFile pf)
```

### Operation

Rejoins the partition in *pf* into folder *foldername* in project *p*.

If successful, returns a null string; otherwise returns a string containing an error message.

---

## removePartition

---

### Declaration

```
string removePartition(Project p,
                      string partName)
```

### Operation

Recovers the information exported in *partName*, which must be the name of a partition exported from project *p*. This removes its partitioned out status, which enables it to be edited. Once removed, the partition can never be rejoined.

If successful, returns a null string; otherwise returns a string containing an error message.

---

## Partition information

This section describes the functions and properties that allow access to the attributes of partitions and partition definitions. Some functions use the data type `PartitionPermission`, which has the same range of values as `Permission`, but applies only to data in partition definitions. This is the data type that confers the maximum access rights for users at the away database, if the partition definition is used to create a partition.

---

## Partition properties

---

Partition properties are defined for use with the `.` (dot) operator and a partition handle to extract information from a partition or partition definition, as shown in the following syntax:

```
variable.property
```

where:

```
variable      is a variable of type PartitionDefinition,
                PartitionModule, PartitionAttribute,
                PartitionView, PartitionFile, InPartition, or
                OutPartition.
```

The properties available vary according to the type being examined.

The types `PartitionDefinition`, `PartitionModule`, `PartitionAttribute`, and `PartitionView` refer to information in a partition definition.

---

You can obtain an object of type	Using
<code>PartitionDefinition</code>	<code>load(partition definition)</code> function or for partition definition in project loop.
<code>PartitionModule</code>	<code>findModule</code> function or for partition module in partition definition loop
<code>PartitionAttribute</code>	<code>findAttribute</code> function or for partition attribute in partition module loop
<code>PartitionView</code>	<code>findView</code> function or for partition view in partition module loop
<code>PartitionFile</code>	<code>open(partition file)</code> function An object of type <code>PartitionFile</code> is created after a user at a home database has exported a partition and created a partition file.
<code>OutPartition</code>	for out-partition in project loop An object of type <code>OutPartition</code> is created after a user at a home database has exported a partition definition. You can only access a type <code>OutPartition</code> using this loop.

---



You can obtain an object of type	Using
InPartition	for in-partition in project loop An object of type InPartition is created after a user at a home database has exported a partition definition. You can only access a type InPartition using this loop.

---

## Partition definition properties

---

After a user at the home database has created a partition definition you can use these properties on a variable of type PartitionDefinition.

String property	Extracts
description	Description of partition definition
name	Name of partition definition

---

## Partition module properties

---

After a user at the home database has created a partition definition you can use this property on a variable of type PartitionModule.

String property	Extracts
name	Name of partition module

---

## Partition attribute properties

---

After a user at the home database has created a partition definition you can use this property on a variable of type PartitionAttribute.

String property	Extracts
name	Name of partition attribute

---

## Partition view properties

---

After a user at the home database has created a partition definition you can use this property on a variable of type PartitionView.

String property	Extracts
name	Name of partition view

---

## Partition file properties

---

After a user at the home database has exported a partition and created a partition file, or after a user at the away database has synchronized or returned a partition, you can use these properties on a variable of type `PartitionFile`.

String property	Extracts
<code>author</code>	The user who created the partition file
<code>date</code>	Date the partition file was created
<code>definitionName</code>	Name of partition definition
<code>description</code>	Description of partition contained in file
<code>name</code>	Name of partition contained in file
<code>subtype</code>	If the type is <code>Initial</code> , returns <code>"ReadOnly"</code> if the file contains a partition in which all the data is read-only. Otherwise, returns <code>"Writeable"</code> .  If the type is <code>Final</code> , returns <code>"Final"</code> if the file contains a partition that has been returned for the last time (not synchronized). Otherwise, if the file is a synchronize file, returns <code>"Intermediate"</code> .
<code>timestamp</code>	Timestamp of partition file
<code>type</code>	Returns <code>"Initial"</code> if the file contains a partition that is yet to be imported into the away database.  Returns <code>"Final"</code> if the file contains a partition that has been returned or synchronized from the away database, and which should be rejoined or synchronized at the home database.

---



---

## Out-partition properties

---

After a partition has been exported, the user at the home database can use these properties on a variable of type `OutPartition`.

String property	Extracts
<code>author</code>	The user who exported the partition
<code>applyDate</code>	Date the partition was exported
<code>definitionName</code>	Name of partition definition
<code>description</code>	Description of partition
<code>folderName</code>	Folder that contains all of the modules included in the partition definition

---

String property	Extracts
name	Name of partition
rejoinedBy	User who rejoined the partition
rejoinedDate	Date the partition was rejoined

---

## In-partition properties

---

After a partition has been imported, the user at the away database can use these properties on a variable of type `InPartition`.

String property	Extracts
acceptDate	Date the partition was imported to the away database
applyDate	Date the partition was exported from the home database
author	The user who created the partition file
definitionName	Name of partition definition
description	Description of partition
folderName	Folder the partition was accepted into
name	Name of partition
returnedBy	User who returned the partition
returnedDate	Date the partition was returned
type	If the partition contains writable data, returns "Writeable"; otherwise, returns "ReadOnly"

---

## for in-partition in project

---

### Syntax

```
for inPartition in project do {
  ...
}
```

where:

*inPartition* is a variable of type `InPartition`

*project* is a variable of type `Project`

## Operation

Assigns *outPartition* to be each successive imported partition record in the specified project. This is primarily for use in the away database.

---

### for out-partition in project

---

#### Syntax

```
for outPartition in project do {
  ...
}
```

where:

<i>outPartition</i>	is a variable of type <code>OutPartition</code>
<i>project</i>	is a variable of type <code>Project</code>

#### Operation

Assigns *outPartition* to be each successive exported partition record in the specified project. This is primarily for use in the home database.

---

### for partition definition in project

---

#### Syntax

```
for partDefinition in project do {
  ...
}
```

where:

<i>partDefinition</i>	is a variable of type <code>PartitionDefinition</code>
<i>project</i>	is a variable of type <code>Project</code>

#### Operation

Assigns *partitionDefinition* to be each successive partition definition within the specified project.

---

## Partition access

This section describes the functions and properties that manage the partition and rejoin access rights.

---

## isPartitionedOut, isPartitionedOutDef, isPartitionedOutVal

---

### Declaration

```
string
isPartitionedOut({Item i|Folder f|Project p|
                 Module m|Object o|View v},
                 bool &result)

string isPartitionedOut(AttrType at,
                       bool &result)

string isPartitionedOutDef(AttrDef ad,
                           bool &result)

string isPartitionedOutVal(AttrDef ad,
                           bool &result)
```

### Operation

If the current user has read access to the entity identified by the argument, sets *result* to indicate whether the entity is partitioned out, and returns a null string. If the current user does not have read access, returns an error message.

---

## getPartitionMask, getPartitionMaskDef, getPartitionMaskVal

---

### Declaration

```
string
getPartitionMask({Item i|Folder f|Project p|
                 Module m|Object o|View v},
                 Permission &p)

string getPartitionMask(AttrType at,
                       Permission &p)

string getPartitionMaskDef(AttrDef ad,
                           Permission &p)

string getPartitionMaskVal(AttrDef ad,
                           Permission &p)
```

### Operation

This perm should only be used in the away database.

If the current user has read access to the entity identified by the argument, sets *p* to a mask of the entity's permissions, and returns a null string. The mask describes the maximum access allowed to users in the away database. If the current user does not have read access, returns an error message.

If the data is partitioned in, the mask passed back is a bitwise OR of read, create, modify, and delete, access rights. If the data is not partitioned in, the mask is null.



## Chapter 27

# Requirements Interchange Format (RIF)

This chapter describes features that operate on Rational DOORS Requirements Interchange Format (RIF):

- RIF export
- RIF import
- RIF ID
- Merge
- RIF definition
- Examples

---

## RIF export

---

### exportType

---

#### Declaration

```
void initRIFExport(ExportType)
```

#### Operation

Sets the export type to be either RIF or ReqIF. Call this before using the `exportPackage` method.

#### example

```
initRIFExport(exportRIF_1_2) // Sets the export to be RIF
initRIFExport(exportReqIF) // Sets the export to be ReqIF
```

---

### exportPackage

---

#### Declaration

```
string exportPackage(RifDefinition def, Stream RifFile, DB parent, bool& cancel)
```

#### Operation

Exports *def* to the XML file identified by *RifFile*. The stream must be have been opened for writing using “*write (filename, CP\_UTF8)*”. If *parent* is null then a non-interactive operation is performed. Otherwise, progress bars will be displayed.

If an interactive export is performed, and is cancelled by the user, *cancel* will be set to *true*.

---

# RIF import

---



---

## importRifFile

---

### Declaration

```
string importRifFile(string RifFilename, Folder parent, string targetName,
string targetDesc, string RifDefName, string RifDefDescription, DB parent)
```

### Operation

Performs a non-interactive import of *RifFileName*, placing the imported modules in a new folder in the specified *parent*. The new folder name and description are specified by *targetName* and *targetDesc*.

---

## RifImport

---

A `RifImport` is an object which contains information on a RIF import. These are created by import operations, and are persisted in a list in the stored `RifDefinition`.

Properties are defined for use with the `.` (dot) operator and a `RifImport` handle to extract information from, or specify information in an import record, as shown in the following syntax:

```
variable.property
```

where:

*variable* is a variable of type `RifImport`.

*property* is one of the properties.

The following tables list the `RifImport` properties and the information they extract or specify:

<b>bool property</b>	<b>Extracts</b>
<code>mergeStarted</code>	Returns true when a merge operation is started.
<code>mergeCompleted</code>	Returns true when the merge has been completed.
<code>mergeRequired</code>	Returns true when an import is a valid candidate for merging.
<code>mergeDisabled</code>	Returns true if the merge has been disabled due to lock removal.

<b>User property</b>	<b>Extracts</b>
<code>importedBy</code>	Returns the user who performed the import.
<code>mergedBy</code>	Returns the user who performed the merge.



Folder property	Extracts
<code>folder</code>	Returns the folder containing the imported data. On import, a DXL script is expected to iterate through the contents of this folder, merging all items which have RIF IDs, and which are persisted in this folder.

Date property	Extracts
<code>exportTime</code>	Returns the time the export was performed. Note that this is the timestamp derived from the <code>creationTime</code> element of the header in the imported RIF package. Merges should be performed in the order in which the data was exported, rather than the order in which the packages were imported.
<code>importTime</code>	Returns the date that the import folder was created.
<code>mergeTime</code>	Returns the date that the merge of the import folder was completed, or started if it has not yet been completed.

---

## RIF ID

---

### getRifID

---

#### Declaration

```
string getRifID(Object o)
```

#### Operation

Returns a string with the RIF ID for object *o*. If the object does not have a RIF ID, an empty string is returned.

---

### getObjectByRifID

---

#### Declaration

```
Object getObjectByRifID(Module m, string s)
```

#### Operation

Returns the object within module *m* with a RIF ID of *s*. If the module does not contain an object with the input RIF ID, `null` is returned.

---

# Merge

---

## rifMerge

---

### Declaration

```
string rifMerge(RifImport mrgObj, DB parent)
```

### Operation

Performs a non-interactive merge using the information in *mrgObj*.

---

# RIF definition

---

## RifDefinition

---

A `RifDefinition` is the object in which a package to be exported in RIF format is defined.

Properties are defined for use with the `.` (dot) operator and a `RifDefinition` handle to extract information from a definition, as shown in the following syntax:

```
variable.property
```

where:

*variable* is a variable of type `RifDefinition`.

*property* is one of the following properties.

The following tables list the `RifDefinition` properties and the information they extract or specify

String property	Extracts
<code>name</code>	The name of the definition.
<code>description</code>	The description of the definition.
<code>rifDefinitionIdentifier</code>	The unique ID of the RIF definition (this is shared between databases, unlike the name and description).

---

boolean property	Extracts
<code>createdLocally</code>	Returns <code>true</code> if the definition was created in the local database, as opposed to being imported.

---

<b>boolean property</b>	<b>Extracts</b>
<code>canModify</code>	Returns true if the correct user can modify the definition.

<b>Project property</b>	<b>Extracts</b>
<code>project</code>	The project which contains the definition.

---

## RifModuleDefinition

---

A `RifModuleDefinition` is an object which contains the details of how a module should be exported, as part of a RIF package.

Properties are defined for use with the `.` (dot) operator and `RifModuleDefinition` handle to extract information from, a definition record, as shown in the following syntax:

```
variable.property
```

where:

*variable* is a variable of type `RifModuleDefinition`.

*property* is one of the properties below.

The following tables list the `RifModuleDefinition` properties and the information they extract or specify:

<b>String property</b>	<b>Extracts</b>
<code>dataConfigView</code>	The name of the view used to define which data in the module will be included in the RIF export.
<code>ddcView</code>	The name of the view used to define what data can be edited when the exported RIF package is imported into another database.

<b>bool property</b>	<b>Extracts</b>
<code>createdLocally</code>	Whether the module was added to the <code>RifDefinition</code> in the current database or not.

<b>ModuleVersion property</b>	<b>Extracts</b>
<code>moduleVersion</code>	The <code>ModuleVersion</code> reference for the given <code>RifModuleDefinition</code> .

<b>Ddcmode property</b>	<b>Extracts</b>
<code>ddcMode</code>	The type of access control used to define whether the module, or its contents, will be editable in each database once it has been exported.

---

## DdcMode constants

---

DdcMode constants define the type of access control used define whether a module, or its contents, will be editable in each of the local and target database once the export has taken place. The following table details the possible values, and their meanings.

Constant	Meaning
<code>ddcNone</code>	Module will be editable in both source and target databases.
<code>ddcReadOnly</code>	Module will be editable in only the source database.
<code>ddcByObject</code>	Selected objects in the module will be made read-only in the source database.
<code>ddcByAttribute</code>	Selected attributes in the module will be made read-only in the source database.
<code>ddcFullModule</code>	Module will not be editable.

---



---

## for RifDefinition in Project

---

### Syntax

```
for rifDef in proj do {
...
}
```

### Operation

Assigns *rifDef* to be each successive RifDefinition in Project *proj*.

---



---

## for RifModuleDefinition in RifDefinition

---

### Syntax

```
for rifModDef in rifDef so {
...
}
```

### Operation

Assigns *rifModDef* to be each successive RifModuleDefinition in RifDefinition *rifDef*.

---

## for RifImport in RifDefinition

---

### Syntax

```
for rifImp in rifDef do {
...
}
```

### Operation

Assigns *rifImp* to be each successive *rifImport* in *RifDefinition rifDef*.

---

## Examples

---

### Example 1

---

This example dumps all information about all RIF definitions in the current project to the screen. It then conditional exports one of the packages.

```
RifDefinition rd
RifModuleDefinition rmd
Stream stm = write ("C:\\Public\\rifExport.xml", CP_UTF8)
string s = ""
bool b
Project p = current
Project p2
ModuleVersion mv
DB myDB = null
DdcMode ddcM

for rd in p do {

    print rd.name "\n"
    print rd.description "\n"
    print rd.rifDefinitionIdentifier "\n"

    if (rd.createdLocally) {
```

```
    print "Local DB\n"
}

if (rd.canModify) {

    print "May be modified by current user\n"
}

p2 = rd.project

print fullName p "\n"

for rmd in rd do {

    print "\nModules present in definition :\n"

    mv = rmd.moduleVersion
    print fullName mv "\t"

    print rmd.dataConfigView "\t"
    print rmd.ddcView "\t"

    if (rmd.createdLocally) {

        print "Home DB.\n"
    }

    ddcM = rmd.ddcMode

    if (ddcM == ddcFullModule){

        print "Module will not be editable once definition is exported.\n"
```

```
    } else if (ddcm == ddcByObject){

        print "Selected objects will be locked in the local database once the
definition is exported.\n"

    } else if (ddcm == ddcByAttribute){

        print "Selected attributes will be locked in the local database once
the definition is exported.\n"

    } else if (ddcm == ddcReadOnly){

        print "Module will only be editable in the local database once
definition is exported.\n"

    } else if (ddcm == ddcNone){

        print "Module will be fully editable in both local and target
databases when definition is exported.\n"

    }

}

if (rd.name == "RifDef1"){

    s = exportPackage (rd, stm, myDB, b)

    if (s != ""){

        print "Error occurred : " s "\n"

    }

}

}
```

---

## Example 2

---

This example dumps all information about all RIF imports in the current project. It then merges those imports where required.

```
RifImport ri
RifDefinition rd
Project p = current
User importer, merger
string importerName, mergerName, res
Folder f
Skip dates = create

for rd in p do {

    for ri in rd do {

        rd = ri.definition
        print rd.name "\n"

        f = ri.folder
        print "Located in : " fullName f
        print "\n"

        importer = ri.importedBy
        importerName = importer.name
        print "Imported by : " importerName "\n"

        print "Imported on : " ri.importTime "\n"

        if (ri.mergeStarted && !ri.mergeCompleted) {

            print "Merge started on : " ri.mergeTime "\n"
```



```
} else if (ri.mergeCompleted) {

    print "Merge completed on : " ri.mergeTime "\n"

}

if (ri.mergeRequired) {

    print "Merge required.\n"
    res = rifMerge (ri, null)
    print "Merging result : " res "\n"

} else {

    merger = ri.mergedBy
    print "Merged by : " mergerName "\n"
}

if (ri.mergeDisabled) {

    print "Merge disabled, locks removed.\n"
}

print "\n"
}

}
```



## Chapter 28

# OLE objects

This chapter provides information on Rational DOORS DXL support for OLE technology. These functions are currently only available on Windows platforms. OLE technology support encompasses the linking and embedding of OLE objects and the use of the system clipboard to manipulate objects that can be embedded and linked to and from. OLE DXL supports automation with Rational DOORS as either client or server.

- Embedded OLE objects and the OLE clipboard
- OLE information functions
- Picture object support
- Automation client support
- Controlling Rational DOORS from applications that support automation

---

## Embedded OLE objects and the OLE clipboard

This section defines DXL functions that allow OLE objects to be manipulated within Rational DOORS, and provide a programmatic means of controlling the OLE clipboard.

---

### oleActivate

---

#### Declaration

```
bool oleActivate(Object o)
string oleActivate(Object o, Column c, integer index)
```

#### Operation

The first form activates the first OLE object embedded in the object text of *o*. The function returns `true` if the object text of *o* contains an OLE object and the activation of that object succeeds. Otherwise, it returns `false`.

The second form activates the OLE object at position *index* in the column *c*, for the object *o*.

The command uses the OLE object's primary verb. For example, a Word object chooses to open in edit mode, while a video object chooses to play.

#### Example

```
/*
   this code segment checks whether the object text of the current formal object
   contains an OLE object, and if so, activates the first one.
*/
Object obj = current
```

```

if (oleIsObject obj){
    if (oleActivate obj == false){
        print "Problem trying to activate object\n"
    }
} else {
    print "Does not contain an embedded object in its object text\n"
}
/*
    this DXL script activates the second OLE object that exists
    in column 1 of the module display
*/
oleActivate(current Object, column 1, 1)

```

---

## oleDeactivate

---

### Declaration

```

bool oleDeactivate(Object o)
bool oleDeactivate(Object o, Column col, int oleIndex)

```

### Operation

Deactivates the OLE object embedded *o*. The function returns `true` if *o* contains an activated OLE object and the deactivation succeeds. Otherwise, it returns `false`.

The second variant of this perm deactivates the OLE object specified by *oleIndex* in the specified column of the passed formal object. If the `oleGetAutoObject()` function was called to get the object's dispatch pointer, the `oleCloseAutoObject()` function must be called to release the dispatch pointer before calling this function.

### Example

```

/*
this code segment checks whether the current formal object contains an OLE
object in its object text, and if so, deactivates it
*/
Object obj = current
if (oleIsObject obj){
    if (oleDeactivate obj == false){
        print "Problem trying to deactivate
            object\n"
    }
} else {
    print "Does not contain an embedded object\n"
}

```

---

## oleCopy

---

### Declaration

```
bool oleCopy(EmbeddedOleObject oleObject)
string oleCopy(Object o, Column c, integer index)
```

### Operation

The first form copies the embedded OLE object *oleObject* into the system clipboard. The OLE object can then be pasted into another Rational DOORS formal object or into any other Windows application that supports automation.

The second form copies the embedded OLE object at position *index* in *column c* for *object o*, into the system clipboard. The OLE object can then be pasted into another Rational DOORS formal object or into any other Windows application that supports automation.

### Examples

```
void checkOLECopy(Object o, string attributeName)
{
    RichText rtf
    string s = richTextWithOle o.attributeName
    for rtf in s do
    {
        if (rtf.isOle)
        {
            EmbeddedOleObject ole = rtf.getEmbeddedOle
            oleCopy(ole)
            break
        }
    }
}

checkOLECopy(current Object, "Object Text")
/*
    this example copies the first OLE object in
    the current object, in column 1.
*/
string s = oleCopy(current Object, column 1, 0)
```

---

## oleCut

---

### Declaration

```
string oleCut(Object o, Column c, integer index)
bool oleCut(Object o)
```

### Operation

The first form cuts the embedded OLE object at position *index* in column *c* for object *o*, into the system clipboard. The OLE object can then be pasted into another Rational DOORS formal object or into any other Windows application that supports automation.

The second form cuts the embedded OLE object *o* into the system clipboard. The OLE object can then be pasted into another Rational DOORS formal object or into any other Windows application that supports automation.

The function returns `true` if *o* contains an OLE object and the cut operation succeeds. Otherwise, it returns `false`.

### Example

```
/*
  this code segment checks whether the current formal object
  contains an OLE object in its object text, and if it so, cuts it to the
  system clipboard, and then pastes it into the next formal
  object in the current formal module
*/
Object obj = current
if (oleIsObject obj){
  if (oleCut obj){
    obj = next current
    if (obj != null){
      if (olePaste obj == false)
        print "Problem trying to paste object\n"
    }
  } else {
    print "Problem trying to cut object\n"
  }
} else {
  print "Does not contain an embedded object in its object text\n"
}
/*
  this DXL script cuts the second OLE object that exists in
  column 1 of the module display
*/
string s = oleCut(current Object, column 1, 0)
```

---

## oleDelete

---

### Declaration

```
bool oleDelete(Object o)
string oleDelete(Object o, Column c, integer index)
```

### Operation

The first form removes the embedded OLE object from the object text of *o*. The function returns `true` if the object text of *o* contains an OLE object and the removal of that object succeeds. Otherwise, it returns `false`.

The second form deletes the OLE object in column *c*, for object *o*, at the index *index*.

### Example

```
/*
this code segment removes an embedded OLE object from the object text of the
current formal object.
*/
oleDelete (current Object)
```

---

## oleInsert

---

### Declaration

```
bool oleInsert(Object o, [attrRef], string fileName, [bool insertAsIcon])
where the optional parameter attrRef is in the following format: (Object o).(string attrName)
```

### Operation

Embeds the file *fileName* as an OLE object in the Rational DOORS formal object *o* in a text attribute. If the optional parameter *attrRef* is specified, then the OLE object is embedded in the user-defined text attribute. If no parameter is specified, then the OLE object is embedded in the system Object Text attribute.

If the optional parameter *insertAsIcon* is specified, then if `true`, the OLE object is displayed as an icon, else it is displayed as content. If no parameter is specified, then the default is to display the OLE object as content.

The function returns `true` on successful insertion of the OLE object. Otherwise, it returns `false`.

An OLE package is created if a file has no associated applications that support OLE. OLE packages even allow executable files to be embedded into documents. It is then possible to execute such a file from within the document.

### Example

```
/*
this code segment embeds an existing word document into the current formal
object
*/
string docName = "c:\\docs\\details.doc"
```

```

Object obj = current
if (oleInsert(obj, obj."my_text", docName)){
    print "Successfully embedded document\n"
} else {
    print "Problem trying to embed document\n"
}

```

---

## oleInsert (insert to buffer)

---

### Declaration

```
bool oleInsert(Buffer bufInsert, string fileName, int charPos)
```

where:

- `bufInsert` is the buffer to insert the OLE into.
- `fileName` is the full filename of the file to insert as an OLE object. (The registered application for the file type must be available.)
- `charPos` is the offset in characters at which to insert the OLE. Any value less than 0 means insert at the end of the buffer.

### Operation

Inserts OLE into the given buffer at a given character offset.

### Example

```

Buffer myBuff = create
if (oleInsert(myBuff, "C:\\example.pdf", -1))
    print (tempStringOf(myBuff)) "\n"
else
    print "Error!\n"
delete myBuff

```

---

## oleIsObject

---

### Declaration

```
bool oleIsObject(Object o)
```

### Operation

Returns `true` if `o` contains an embedded OLE object in its Object Text attribute; otherwise, returns `false`.



## Example

```

/*
this code segment checks to whether the current formal object contains an OLE
object in its Object Text attribute, and if it does not, embeds a word document.
*/

string docName = "c:\\docs\\details.doc"
Object obj = current
if (oleIsObject obj){
    print "Already contains embedded object\n"
} else {
    oleInsert(obj, docName )
}

```

---

## oleCloseAutoObject

---

### Declaration

```
void oleCloseAutoObject (OleAutoObj &oa)
```

### Operation

Closes an open OLE handle (interface) and deallocates the memory associated with it. It also sets the argument passed to it to null.

This function is useful for releasing handles that have been allocated, for example, through the `oleGetAutoObject` function. These handles are not normally released until the DXL program exits.

---

## oleCloseAutoObject

---

### Declaration

```
void oleCloseAutoObject (OleAutoObj &oa)
```

### Operation

Closes an open OLE handle (interface) and deallocates the memory associated with it. It also sets the argument passed to it to null.

This function is useful for releasing handles that have been allocated, for example, through the `oleGetAutoObject` function. These handles are not normally released until the DXL program exits.

---

## oleRTF

---

### Declaration

```
Buffer oleRTF (EmbeddedOleObject, Buffer&)
```

## Operation

Takes a chunk of richtext containing an OLE object, and returns the data as RTF loaded into the supplied buffer. This buffer is also returned allowing it to be used as an immediate assignment.

The buffer is emptied before the RTF is loaded.

## olePaste

### Declaration

```
bool olePaste(Object o)
```

### Operation

Pastes the contents of the system clipboard into the object text of *o* as an embedded OLE object. The function returns true if *o* does not contain an OLE object and the paste operation succeeds. Otherwise, it returns false.

### Example

```
/*
this code segment checks whether the current formal object contains an OLE
object in its object text, and if it so, cuts it to the system clipboard, and
then pastes it into the next formal object in the current formal module
*/

Object obj = current
if (oleIsObject obj){
    if (oleCut obj){
        obj = next current
        if (obj != null){
            if (olePaste obj == false){
                print "Problem trying to paste
                    object\n"
            }
        }
    } else {
        print "Problem trying to cut object\n"
    }
} else {
    print "Does not contain an embedded object in its object text\n"
}
```

## olePasteSpecial

### Declaration

```
string olePasteSpecial(attrRef, bool displayAsIcon)
```

where *attrRef* can be one of:

```
(Object o).(string attrName)
(Module m).(string attrName)
(Link l).(string attrName)
```

## Operation

Copies an OLE object from the clipboard and appends it to *attrRef*. The boolean *displayAsIcon*, when set to `true` will display the OLE object as an icon in the object. Returns null on success and displays an error message on failure.

## Example

```
Object o = current
olePasteSpecial(o."object text", false)
```

## olePasteLink

### Declaration

```
bool olePasteLink(Object o)
bool olePasteLink(attrRef)
where attrRef can be one of:
(Object o).(string attrName)
(Module m).(string attrName)
(Link l).(string attrName)
```

### Operation

The first form pastes the contents of the system clipboard *o* as a link to an OLE object. This function only succeeds if there is enough information about the data in the system clipboard to describe its location. Typically this function is used to link to a section of data in a larger body of data, for example, a paragraph in a Word document. The function returns `true` if *o* does not contain an OLE object and the paste operation succeeds. Otherwise, it returns `false`.

The second form inserts from the system clipboard into the text attribute referred to by *attrRef*.

### Example

```
/*
this code segment checks to see whether the current formal object contains an
OLE object in its object text, and if it does not, pastes a link to the object
described in the system clipboard.
*/
Object obj = current
if (oleIsObject obj == false){
    if (olePasteLink obj == false){
        print "Problem trying to paste link to
            object\n"
```

```

    }
} else {
    print "Does not contain an embedded object\n"
}

```

---

## oleSaveBitmap

---

### Declaration

```
oleSaveBitmap(Object o)
```

### Operation

Forces a write of the picture for the current object. This affects OLE display on UNIX platforms.

### Example

```

Object o = current
oleSaveBitmap (o)

```

---

## oleCount

---

### Declaration

```
int oleCount(attrRef)
```

where *attrRef* can be one of:

```
(Object o).(string attrName)
```

```
(Module m).(string attrName)
```

```
(Link l).(string attrName)
```

### Operation

Returns the number of OLE objects embedded in the attribute (new version of `oleIsObject (Object)`)

### Example

```

Object o = current
int n = oleCount(o."Object Text")
print "Number of OLE objects in Object Text attribute for current object: " n ""

```

---

## isOleObjectSelected

---

### Declaration

```
bool isOleObjectSelected(Object o)
```

## Operation

Returns `true` if an OLE object is selected in the specified Object `o`. If anything other than an OLE object is selected (e.g. text and an OLE object), the function returns `false`. If two or more contiguous OLE objects are selected, the function returns `true`.

## showOlePropertiesDialog

### Declaration

```
void showOlePropertiesDialog(Object o)
```

### Operation

Shows the OLE properties dialog for the selected OLE object in the specified Object `o`.

- If no OLE object is selected, the dialog will not appear.
- If anything other than an OLE object is selected (e.g. text and an OLE object), the function returns `false`.
- If two or more contiguous OLE objects are selected, the options dialog will appear for the first object.

## containsOle

### Declaration

```
bool containsOle(attrRef)
```

where `attrRef` can be one of:

```
(Object o).(string attrName)
```

```
(Module m).(string attrName)
```

```
(Link l).(string attrName)
```

### Operation

Returns true if the specified attribute contains OLE data

### Example

```
Object o = current
if (containsOle(o."Object Text")){
    oleActivate(o)
}
```

---

## OLE information functions

---

### getOleWidthHeight

---

#### Declaration

```
string getOleWidthHeight(EmbeddedOleObject embedOle, int &width, int &height)
```

#### Operation

These functions provide information on Embedded OLE objects as demonstrated by the following examples.

#### Example 1

```
void checkOLEcount(Object o, string attributeName)
{
    int n = oleCount(o.attributeName)
    RichText rtf
    string s = richTextWithOle o.attributeName
    int j = 0
    for rtf in s do
    {
        if (rtf.isOle)
        {
            j++
        }
    }
    if (j != n)
    {
        print "ERROR: oleCount gives " n " and for rtf in string gives " j "\n"
    } else {
        print "OK: they both give " n "\n"
    }
}

Object o = current
checkOLEcount(o, "Object Text")
```

## Example 2

```

void checkExportPicture(Object o, string attributeName, string baseFileName)
{
    EmbeddedOleObject ole
    int i = 1
    string errmess = null
    RichText rtf
    string s = richTextWithOle o.attributeName
    i = 1
    for rtf in s do
    {
        if (rtf.isOle)
        {
            ole = rtf.getEmbeddedOle
            string filename = baseFileName "-rtfloop-" i ".png"
            print "Exporting " filename "\n"
            errmess = exportPicture(ole,filename , formatPNG)
            if (!null errmess)
            {
                print "ERROR: " errmess "\n"
            }
            i++
        }
    }
}
Object o = current
checkExportPicture(o, "Object Text", "C:\\temp\\")

```

## Example 3

```

void checkOLECopy(Object o, string attributeName)
{
    RichText rtf
    string s = richTextWithOle o.attributeName

    for rtf in s do

```

```

    {
        if (rtf.isOle)
        {
            EmbeddedOleObject ole = rtf.getEmbeddedOle
            oleCopy(ole)
            break
        }
    }
}

```

```
checkOLECopy(current Object, "Object Text")
```

#### Example 4

```

void checkOLEWidthHeight(Object o, string attributeName)
{
    EmbeddedOleObject ole
    RichText rtf
    string s = richTextWithOle o.attributeName
    int width, height
    for rtf in s do
    {
        if (rtf.isOle)
        {
            ole = rtf.getEmbeddedOle
            getOLEWidthHeight(ole, width, height)
            print("width = " width ", height = " height "\n")
        }
    }
}

checkOLEWidthHeight(current Object, "Object Text")

```

```
//run with an object containing several OLEs of different sizes in the object
text
```



## Example 5

```
Object o = current
int width
int height
string mess = getPictWidthHeight(o, width, height)
if (null mess)
{
    print "w = " width ", h = " height "\n"
}else{
    print mess "\n"
}
```

Run this against an object with an embedded picture, an object with at least one OLE object in the object text and an object with no OLE objects or pictures.

---

## oleSetMaxWidth

---

### Declaration

```
string oleSetMaxWidth(attrRef, int width)
```

where *attrRef* can be one of:

```
(Object o).(string attrName)
```

```
(Module m).(string attrName)
```

```
(Link l).(string attrName)
```

### Operation

Sets the maximum width of an OLE object in the attribute *attrRef*. Any OLE object wider will be scaled down to fit the column (the aspect ratio will be maintained).

Returns an error message if anything goes wrong.

---

## oleSetMinWidth

---

### Declaration

```
string oleSetMinWidth(attrRef, int width)
```

where *attrRef* can be one of:

```
(Object o).(string attrName)
```

```
(Module m).(string attrName)
```

```
(Link l).(string attrName)
```

## Operation

Sets the minimum width of an OLE object in the attribute *attrRef*. Any OLE object narrower will be scaled up to fit the column (the aspect ratio will be maintained).

Returns an error message if anything goes wrong.

## oleSetHeightandWidth

### Declaration

```
oleSetHeightandWidth(attrRef, int height, int width, int index)
```

where *attrRef* can be one of:

```
(Object o).(string attrName)
```

```
(Module m).(string attrName)
```

```
(Link l).(string attrName)
```

### Operation

Sets the height and width of the OLE object within *attrRef* at the specified index.

### Example

```
Object o = current Object
oleSetHeightandWidth(o."Object Text", 150, 150, 1)
```

## oleResetSize

### Declaration

```
string oleResetSize(attrRef)
```

where *attrRef* can be one of:

```
(Object o).(string attrName)
```

```
(Module m).(string attrName)
```

```
(Link l).(string attrName)
```

### Operation

Resets the width and height of the OLE objects in the attribute *attrRef* to their actual size.

### Example 1

Scale to fit main column

Sets the max and min width of OLEs in the object text to the width of the main column.

```
Object obj
```

```
Column col
```

```

Column mainColumn
for col in current Module do
{
    if (main col)
    {
        mainColumn = col
        break
    }
}
int width = width(mainColumn)
string errmess = ""
for obj in current Module do
{
    int numOles = oleCount(obj."Object Text")
    if (numOles > 0)
    {
        errmess = oleSetMaxWidth(obj."Object Text", width)
        if (!null errmess)
        {
            break
        }
        errmess = oleSetMinWidth(obj."Object Text", width)
        if (!null errmess)
        {
            break
        }
    }
}
if (!null errmess)
{
    print "ERROR:" errmess "\n"
}

```

## Example 2

Reset main column OLEs

Resets the size of all OLE objects in the Object Text

```
Object obj
Column col
Column mainColumn
for col in current Module do
{
    if (main col)
    {
        mainColumn = col
        break
    }
}
int width = width(mainColumn)
string errmess = ""
for obj in current Module do
{
    int numOles = oleCount(obj."Object Text")
    if (numOles > 0)
    {
        errmess = oleResetSize(obj."Object Text")
        if (!null errmess){
            break
        }
    }
}
if (!null errmess)
{
    print "ERROR:" errmess "\n"
}
```

---

## Picture object support

These functions allow DXL to import pictures into Rational DOORS, and work with objects that contain pictures. In Rational DOORS 6.0 and later, pictures are unique to an object, and it is not necessary to identify a picture with a name. The functions using a picture name argument should be used for backwards compatibility only.

---

### Constants

---

The following constants of type `int` are valid values for arguments that specify the format of a picture:

Import format	Description
<code>formatBMP</code>	Bitmap
<code>formatDIB</code>	Bitmap
<code>formatWMF</code>	Windows meta file
<code>formatEPSF</code>	Encapsulated PostScript
<code>formatUNKNOWN</code>	Unknown format

Export format
<code>formatPNG</code>

---

### changePicture

---

#### Declaration

```
bool changePicture(string currentName, string newName)
```

#### Operation

Changes the name of a given picture by passing the current and new names. Returns `true` if the operation succeeds. This function is retained only for compatibility with earlier releases.

---

### copyPictureObject

---

#### Declaration

```
void copyPictureObject(Object source, Object target)
```

## Operation

Copies a picture from the source object to the target object. It generates a run-time DXL error if either argument is null.

### deletePicture

#### Declaration

```
bool deletePicture(Object o)
bool deletePicture(string pictureName)
```

#### Operation

Deletes the picture in object *o*. If the object is not a picture, the call fails.

The second form is retained only for compatibility with earlier releases. All new programs should use the first form.

#### Example

```
if (deletePicture current) {
    print "Successful deletion\n"
} else {
    print "Failed to delete picture\n"
```

### exportPicture

#### Declaration

```
string exportPicture(Object obj,
                    string fileName,
                    int format)
```

#### Operation

Exports a picture, including OLE objects, associated with a given object to the file *fileName* in the specified format. Some pictures, when exported, may have a black border.

The only supported export format is `formatPNG`.

#### Example

```
Object o = current
string n = o."PictureName"
string s = exportPicture(o, n ".png", formatPNG)
if (!null s) {
    print s " : " n "\n"
}
```

---

## exportPicture

---

### Declaration

```
string exportPicture(EmbeddedOleObject oleObject,
                    string fileName,
                    int format)
```

### Operation

Exports a picture, including OLE objects, associated with a given object to the file *fileName* in the specified format.

### Example

```
void checkExportPicture(Object o, string attributeName, string baseFileName)
{
    EmbeddedOleObject ole
    int i = 1
    string errmess = null
    RichText rtf
    string s = richTextWithOle o.attributeName
    i = 1
    for rtf in s do
    {
        if (rtf.isOle)
        {
            ole = rtf.getEmbeddedOle
            string filename = baseFileName "-rtfloop-" i ".png"
            print "Exporting " filename "\n"
            errmess = exportPicture(ole,filename , formatPNG)
            if (!null errmess)
            {
                print "ERROR: " errmess "\n"
            }
            i++
        }
    }
}
Object o = current
checkExportPicture(o, "Object Text", "C:\\temp\\")
```

---

## getPictBB

---

### Declaration

```
void getPictBB(Object o,
               int &llx,
               int &lly,
               int &urx,
               int &ury)
```

### Operation

Returns the picture's bounding box measured in tenths of a point. The bounding box is specified by its lower-left and upper-right co-ordinates.

---

## getPictFormat

---

### Declaration

```
string getPictFormat(Object o)
int getPictFormat(Object o)
```

### Operation

The first form returns the name of the format of the picture in object *o*.

The second form returns an integer corresponding to the format of the picture in object *o*.

Possible format names and integers are:

"EPSF"	1	Encapsulated PostScript
"BMP"	2	Windows Bitmap
"WMF"	3	Windows Meta File

### Example

```
if (getPictFormat current Object != "EPSF") {
    ack "Cannot output this picture format"
    halt
}
```

---

## getPictName

---

### Declaration

```
string getPictName(Object o)
```



## Operation

If `o` contains a picture in a format supported by Rational DOORS, this function returns the picture file name; otherwise, it returns `null`. The returned file name should be treated as a read-only handle. This function is intended for use by exporters.

If the operation fails, returns `null`.

## getPictWidthHeight

### Declaration

```
string getPictWidthHeight(Object o,
                          int &width,
                          int &height,)
```

### Operation

On return, passes back by reference the picture's width and height in pixels. The object must contain either a picture or an OLE object.

On Windows platforms, if it is an OLE object, a bitmap is generated of the OLE object, then the width and height taken of the bitmap.

On UNIX platforms, this function returns the width and height of the picture snapshot of the OLE object (picture snapshots are stored in the database if `oleunix=true` is included in the registry). If a snapshot does not exist, returns an error message to indicate that the width and height are unavailable.

If the operation succeeds, returns `null`; otherwise returns an error message.

### Example

```
int width
int height
Object o = current
bool bIsPicture = o."Picture"
bool bIsOLE = o."OLE"
if(bIsPicture || bIsOLE){
    string errmsg = getPictWidthHeight(o)
    if(null errmsg)
    {
        print "width = " width " ,height=" height
        ""
    } else {
        print errmsg
    }
}
```

---

## importPicture

---

### Declaration

```
bool importPicture(string pictureName,  
                  string fileName,  
                  string format)
```

### Operation

Imports pictures into Rational DOORS. This function is retained for compatibility with earlier releases, but is redundant in Rational DOORS 6.0 and later.

The *pictureName* argument is the name for the picture once it is imported; *fileName* is the file you are importing from; and *format* is the format of the picture, which can be one of "WMF", "BMP" or "EPSF" (case insensitive).

Returns true if the import succeeds; otherwise, returns false.

### Example

```
if (importPicture("Test", "c:\\test.bmp", "BMP")) {  
    print "Successfully imported picture  
        test.bmp\n"  
} else {  
    print "Failed to import picture test.bmp\n"  
}
```

---

## insertBitmapFromClipboard

---

### Declaration

```
bool  
insertBitmapFromClipboard(Object insertHere)
```

### Operation

Inserts a bitmap of any format except an OLE object from the Windows clipboard into the object *insertHere*. The object must already contain a picture, which is replaced. If the operation succeeds, returns true; otherwise, returns false. If *insertHere* is null, the call fails.

For UNIX platforms, returns false.

---

## saveClipboardBitmapToFile

---

### Declaration

```
bool saveClipboardBitmapToFile(string fileName)
```

### Operation

If there is a valid bitmap on the Windows clipboard, saves it to the specified file. The argument *fileName* can be an absolute or relative path. If the operation succeeds, returns true; otherwise, returns false.

For UNIX platforms, returns false.

### Example

```
string FileName=tempFileName()
saveClipboardBitmapToFile(FileName)
```

## insertPictureAfter

### Declaration

```
bool insertPictureAfter(string pictureName, Object insertHere)
```

### Operation

Inserts picture *pictureName* after an object *insertHere*. This function is supported only for compatibility with earlier releases. In new programs, use the `insertPictureFileAfter` function.

### Example

```
if (insertPictureAfter("Test", current Object)) {
    print "Successful picture insertion\n"
} else {
    print "Failed to insert the picture\n"
```

## insertPictureBelow

### Declaration

```
bool insertPictureBelow(string pictureName, Object insertHere)
```

### Operation

Inserts picture *pictureName* below an object *insertHere*. This function is supported only for compatibility with earlier releases. In new programs, use the `insertPictureFileBelow` function.

### Example

```
if (insertPictureBelow("Test", current Object)) {
    print "Successful picture insertion\n"
} else {
    print "Failed to insert the picture\n"
}
```

## insertPictureFile

### Declaration

```
bool insertPictureFile(string fileName,
                      int format,
                      Object insertHere)
```

## Operation

Inserts picture *fileName* into object *insertHere*, which must be a picture object. If the operation succeeds, an existing picture in the object is replaced with that in *fileName*. The format argument can be one of the import values listed in “Constants,” on page 751.

## Example

```
Object currentObject = current
bool Result = false
string BitmapFileName = "c:\\test.bmp"
if (currentObject == null) {
    //No objects currently exist in the module
    Result = insertPictureFile(BitmapFileName,
        formatBMP,currentObject)
} else {
    Result = insertPictureFile(BitmapFileName,
        formatBMP,currentObject)
}
if(Result) {
    print "Successful picture insertion\n"
}
```

---

## insertPictureFileAfter

---

### Declaration

```
bool insertPictureFileAfter(string fileName,
    int format
    Object insertHere)
```

### Operation

Inserts picture *fileName* after an object *insertHere*. The format argument can be one of the import values listed in “Constants,” on page 751.

### Example

```
Object currentObject = current
bool Result = false
string BitmapFileName = "c:\\test.bmp"
if (currentObject == null) {
    //No objects currently exist in the module
    Result = insertPictureFileAfter(BitmapFileName,
        formatBMP,null)
} else {
    Result = insertPictureFileAfter(BitmapFileName,
        formatBMP,currentObject)
```

```

}
if(Result) {
    print "Successful picture insertion\n"
}

```

---

## insertPictureFileBelow

---

### Declaration

```

bool insertPictureFileBelow(string fileName,
                           int format
                           Object insertHere)

```

### Operation

Inserts picture *fileName* below an object *insertHere*. The format argument can be one of the import values listed in “Constants,” on page 751.

### Example

```

Object currentObject = current
bool Result = false
string BitmapFileName = "c:\\test.bmp"
if (currentObject == null) {
    //No objects currently exist in the module
    Result = insertPictureFileBelow(BitmapFileName,
                                    formatBMP,null)
} else {
    Result = insertPictureFileBelow(BitmapFileName,
                                    formatBMP,currentObject)
}
if(Result) {
    print "Successful picture insertion\n"
}

```

---

## oleLoadBitmap

---

### Declaration

```

Bitmap oleLoadBitmap(DBE dialog,
                    Object fromHere,
                    bool lockColors,
                    int& width,
                    int& height)

```

### Operation

Returns a bitmap handle for the given OLE object, provided the OLE bitmap has been stored.

The handle to the bitmap can then be used to draw the picture onto a canvas.

The function requires passed width and height; when the function exits these become the width and height of the picture.

OLE bitmaps are only stored in Rational DOORS 4.1 and later releases, and then only if you have not run Rational DOORS with the command line option to prevent it storing the picture.

### Example

```
b = oleLoadBitmap(dbMain, current Object, true,
                 w, h)

DBE dbMain
void doDraw(DBE dbMain) {
    Bitmap b
    int w, h
    b = oleLoadBitmap(dbMain, current Object, true,
                     w, h)
    drawBitmap(dbMain, b, 0,0)
}
DB artBox = create "Try resizing"
dbMain = canvas(artBox, 400, 300, doDraw)
show artBox
```

---

## openPictFile

---

### Declaration

```
Stream openPictFile(Object o)
```

### Operation

Opens a read-only stream for the file containing the picture referenced in the named object.

### Example

```
Stream picture = openPictFile thisObj
```

---

## pictureCopy

---

### Declaration

```
bool pictureCopy(Object object)
```

### Operation

On Windows platforms only, copies the picture in the specified object to the system clipboard.

### Example

```
bool Result = pictureCopy(current)
```

```

if(Result) {
    print "Picture successfully copied\n"
} else {
    print "Picture not copied\n"
}

```

---

## reimportPicture

---

### Declaration

```
bool reimportPicture(string pictureName)
```

### Operation

This function is provided only for compatibility with earlier releases. It has no effect in Rational DOORS 6.0 or later.

---

## for pictures in project

---

### Syntax

```

for s in pictures(Project p) do {
    ...
}

```

where:

*s* is a string variable

*p* is a project of type Project

### Operation

This loop is retained for compatibility with earlier release. Because of the changes to access restrictions in Rational DOORS 6.0, where pictures are specific to a module, this loop returns the names of the pictures in the current module only.

### Example

This example prints the names of all pictures in the current module.

```

string s
for s in pictures current Project do {
    print s " \n"
}

```

---

## supportedPictureFormat

---

### Declaration

```
bool supportedPictureFormat(int format)
```

## Operation

Returns true if the specified format is supported by the current client.

## Example

```
if(supportedPictureFormat(formatWMF)){
    print "WMF format is supported.\n"
}
```

## pictureCompatible

### Declaration

```
bool pictureCompatible(string filename, int format)
```

### Operation

Returns true if the specified file has header information which indicates that it contains a picture of the specified format.

### Example

```
string fileName = "C:\\temp\\mypic.bmp"
if(pictureCompatible(fileName, formatBMP)){
    print fileName " is a valid BMP file.\n"
}
```

## Automation client support

This section defines DXL functions with which Rational DOORS can be used as an automation client. That means Rational DOORS can be used to control other Windows applications that provide automation interface objects. Information on interface objects, methods and properties for other applications is available in the relevant automation documentation.

The functions fall into three groups:

- Accessing an interface
 

The DXL functions `oleCreateAutoObject` and `oleGetAutoObject` provide access to automation interfaces in other applications. In addition to obtaining interface objects in these specific ways, interface objects can also be retrieved by accessing the properties or making method calls to other interface objects.
- Getting and setting properties
 

The DXL functions `oleGet` and `olePut` provide access to automation object properties. The values of a property can be retrieved from an automation object, and where the object enables it, they can also be set.
- Calling automation methods



In addition to providing access to properties, automation interfaces can also provide methods. These provide access to capability in the other application and can return data as a result of their execution. In addition they might require data to be passed to them as arguments. Rational DOORS provides support for automation methods with the various `oleMethod` functions, the `OleAutoArgs` variable type and the various functions that can be used to manipulate variables of that type: `create (OleAutoArgs)`, `delete (OleAutoArgs)`, `clear (OleAutoArgs)`, `put (OleAutoArgs)`, and `oleMethod`.

---

## oleGetResult

---

### Declaration

```
string oleGetResult()
```

### Operation

Rational DOORS provides the read-write `Result` property to automation clients, enabling them to exchange information with DXL programs. This function gets the value of this property.

### Example

```
if (oleGetResult == "OK") {
    // operation was successful
}
```

---

## oleSetResult

---

### Declaration

```
void oleSetResult(string message)
```

### Operation

Rational DOORS provides the read-write `Result` property to automation clients, enabling them to exchange information with DXL programs. This function sets the value of this property.

---

## oleCreateAutoObject

---

### Declaration

```
OleAutoObj
oleCreateAutoObject(string autoObjName)
```

### Operation

Obtains a reference to a named automation interface. With a type `OleAutoObj` it is then possible to access properties and call methods. The application to support the interface object is started when this function is called.

### Example

```
OleAutoObj theWordApp = oleGetAutoObject("Word.Application")
```

```

if (null theWordApp){
    theWordApp =
        oleCreateAutoObject("Word.Application")
}
olePut (theWordApp, "visible", true)
infoBox "Now you see it."
olePut (theWordApp, "visible", false)
infoBox "Now you don't."

```

---

## oleGetAutoObject

---

### Declaration

```

OleAutoObj oleGetAutoObject(Object o)
OleAutoObj oleGetAutoObject(string autoObjName)

```

### Operation

The first form obtains a reference to an automation interface object for the OLE object embedded in *o*. The OLE object must be activated using the `oleActivate()` function before calling this function. With a type `OleAutoObj` it is then possible to access properties and call methods. The application to support the interface object is started when this function is called.

This function returns the base level interface to the embedded object. Not all objects that support embedding and automation also support automation of embedded objects. For objects that are not supported, null is returned.

The second form obtains a reference to an instance of the application that is already running. For an example of its use, see the example for the `oleCreateAutoObject` function.

---

## oleGet

---

### Declaration

```

string oleGet(OleAutoObj autoObj,
             string propertyName,
             [OleAutoArgs argumentList,]
             {string|int|bool|char|OleAutoObj}
             &Result)

```

### Operation

Obtains the value of a specified property for a specified automation object, with optionally a list of arguments of type `OleAutoArgs`, and with *Result* set to the appropriate type.

The variation of this function that enables access to an `OleAutoObj` value is particularly useful when controlling an application that has a hierarchy of objects.

If the value of a property is successfully returned, returns null; otherwise returns a string containing an error message.

## Example

This example obtains a reference to an automation interface to Excel, gets the visible attribute, and makes it visible if it is hidden:

```
OleAutoObj objExcel = oleCreateAutoObject("Excel.Application")

if (objExcel != null){
    bool excelVisible
    oleGet(objExcel, "Visible", excelVisible)

    if (excelVisible == false){
        olePut(objExcel, "Visible", true)
    }
}
```

---

## olePut

---

### Declaration

```
string olePut(OleAutoObj autoObj,
              string propertyName,
              {string|int|char|bool|OleAutoObj}
              newValue)
```

### Operation

Sets the value of a specified property for a specified automation object, with *newValue* set to the appropriate type. If the value of a property is successfully set, returns null; otherwise, it returns a string containing an error message.

---

## create(OleAutoArgs)

---

### Declaration

```
OleAutoArgs create(void)
```

### Operation

Initializes and returns a type *OleAutoArgs* variable.

### Example

```
/*Typical call to create for an OleAutoArgs variable*/
OleAutoArgs autoArgs = create
```

---

## delete(OleAutoArgs)

---

### Declaration

```
void delete(OleAutoArgs autoArgs)
```

## Operation

Destroys a type `OleAutoArgs` variable and frees any system resources used by it. After a type `OleAutoArgs` variable has been deleted with this function, it becomes invalid and cannot be used again until initialized with the `create (OleAutoArgs)` function.

## Example

This example is a typical call to delete for a variable of type `OleAutoArgs`:

```
OleAutoArgs autoArgs = create
delete (autoArgs)
```

## clear(OleAutoArgs)

### Declaration

```
void clear(OleAutoArgs autoArgs)
```

### Operation

Empties the contents of a type `OleAutoArgs` variable, returning it to the state it was in immediately after it was initialized with the `create` command. This enables a single type `OleAutoArgs` variable to be created and then reused again and again throughout a DXL application.

### Example

This example is a typical call to clear for a variable of type `OleAutoArgs`:

```
OleAutoArgs autoArgs = create
clear (autoArgs)
/*
code using the same autoArgs variable for something different
*/
delete (autoArgs)
```

## put(OleAutoArgs)

### Declaration

```
void put(OleAutoArgs autoArgs,
        [string argName,]
        {string|int|char|bool|OleAutoObj} value)
```

### Operation

Stores a value of the appropriate type in a type `OleAutoArgs` variable `autoArgs`. The optional argument `argName` enables arguments to be named. If it is omitted, the values are inserted into the argument block in the order in which they are supplied.

This means that where the automation object supports named arguments, the formal ordering of arguments is not necessary. Both named and ordered arguments are permitted in the same `OleAutoArgs` variable.

For examples of usage see the example for the `oleMethod` function.

---

## oleMethod

---

### Declaration

```
string
oleMethod(OleAutoObj autoObj,
          string methodName
          [,OleAutoArgs autoArgs
          [, {string|int|char|bool|OleAutoObj}
            result]])
```

### Operation

Uses a specific automation interface to call a specific automation method. Optionally you can specify an argument block. With an argument block, optionally, you can specify a return value of a specific type. If the operation succeeds, `oleMethod` returns `null`; otherwise, it returns a string containing an error message.

---

## Controlling Rational DOORS from applications that support automation

This section defines functions for controlling Rational DOORS from other applications that support automation. For example, Visual Basic macros can be created in Excel to send commands to Rational DOORS.

---

### Automation interface

---

Rational DOORS provides an automation interface for other applications to use to control Rational DOORS. This object is called `DOORS.Application`. It provides two methods that can be called from other applications, along with the property `Result`.

The property, `DOORS.Application.Result`, enables other applications to exchange information with Rational DOORS in both directions. From Rational DOORS, use the `oleGetResult` and `oleSetResult` functions to pass information to and from a Visual Basic program.

### Example

```
/*
This is an example of an Excel macro that calls Rational DOORS, logging in as
user 'John Smith' with password 'password', and sets the result message for use
with oleGetResult.
*/
Sub testDoors()
```

```

Set DOORSObj = CreateObject("DOORS.Application")
SendKeys "John Smith" & "{TAB}" & "password" & _
"{ENTER}", True
DOORSObj.Result = "Just checking"
End Sub

Sub testDoors()
Set DOORSObj = CreateObject("DOORS.Application")
SendKeys "John Smith" & "{TAB}" & "password" & _
"{ENTER}", True
DOORSObj.runFile ("c:\doors\lib\dxl\example\ddbintro.dxl")
End Sub

(runStr sample)
Sub testDoors()
Set DOORSObj = CreateObject("DOORS.Application")
SendKeys "John Smith" & "{TAB}" & "password" & _
"{ENTER}", True
DOORSObj.runStr ("current = create(""Demo"", ""Demo"", "", 1); Object o =
create current Module; o."Object Heading" = ""From Excel via OLE"")
End Sub

```

---

## runFile

---

### Syntax

```
runFile(dxlFileName)
```

where:

*dxlFileName* is a full path

### Operation

This method enables other applications to pass Rational DOORS the path and file name of a DXL file, then requests Rational DOORS to run it.

### Example

This example is an Excel macro that calls Rational DOORS, logging in as user **John Smith** with password **password**, and requests it to run the `ddbintro` example from the DXL library:

```

Sub testDoors()
  Set DOORSObj = CreateObject("DOORS.Application")
  SendKeys "John Smith" & "{TAB}" & "password" &
    "{ENTER}", True
  DOORSObj.runFile ("c:\doors\lib\dxl\example\
    ddbintro.dxl")
End Sub

```

**Note:** There has been a change in functionality between Rational DOORS 7.x and Rational DOORS 8 concerning `runFile`. Any files passed to `runFile` must be transcoded to UTF-8 encoding rather than Latin-1. Alternatively, you can use `runStr` to `#include` a file. The behavior of `runStr` is unchanged since version 7.

---

## runStr

---

### Syntax

```
runStr(dxlText)
```

where:

*dxlText* is a string

### Operation

This method enables other applications to pass Rational DOORS a string containing DXL functions for Rational DOORS to execute.

You can send more than one line to `runStr` at a time by using `\n` or `;` in the string.

### Example

This example is an Excel macro that calls Rational DOORS, logging in as user **John Smith** with password **password**, and requests it to create a new module. The macro then creates an object in the module:

```

Sub testDoors()
  Set DOORSObj = CreateObject("DOORS.Application")
  SendKeys "John Smith" & "{TAB}" & "password" &
    "{ENTER}", True
  DOORSObj.runStr("current = create(""Demo"",
    ""Demo"", "", 1);
  Object o = create first current Module;
  o."Object Heading" = "From Excel via OLE" "")
End Sub

```





## Chapter 29

# Triggers

This chapter describes triggers, a powerful mechanism for associating Rational DOORS scripts with events in Rational DOORS.

- Introduction to triggers
- Trigger constants
- Trigger definition
- Trigger manipulation
- Drag-and-drop trigger functions

---

## Introduction to triggers

Triggers are a mechanism in DXL for associating an event, such as opening a project or modifying an attribute, with a DXL program. This provides a very powerful customization facility that can be used for a number of tasks, including process enforcement. Triggers are created, managed, and deleted in DXL.

**Note:** Rational DOORS Web Access does not support triggers.

There are two examples demonstrating the use of triggers: `defview.dxl` and `delview.dxl` that permit the automatic loading of a user's preferred view in a formal module. These are in the directory called: `$DOORSHOME/lib/dxl/example`

Triggers are described in terms of **level**, **type** and **event**.

There are five trigger levels:

- module
- object
- attribute\*
- discussion
- comment

\*The use of module-level system attributes, such as Name and Description, is not supported with triggers.

There is one trigger type:

- post

There are two trigger events:

- A **pre-event** trigger is a mechanism for performing an action or a check before an event happens. The code executed can return a veto, which prevents the subsequent event from happening. When multiple triggers have been defined for the same event, trigger execution is ordered on the trigger's priority. For a pre-event to succeed, all pre-events must succeed.
- A **post-event** trigger is executed after the associated event happens, for example after a module is opened.

---

## Basic trigger events

---

There are seven basic event types:

Event	Synonyms
open	edit, read
close	
save	write, modify
sync	
drag	
drop	
create	

The only current application for the sync event is changing the current object in a formal and link module. The following table shows currently supported event and level combinations:

	open	close	save	sync	drag	drop	create
module	x	x					
object	x			x	x	x	
attribute			x				
discussion							x
comment							x

Both pre-event and post-event types are supported for all marked combinations.

Trigger levels have the following two extra dimensions: **scope** and **priority**.

The object open event will only occur when double-clicking on the object. Viewing the object through Object Properties will not cause an open event.

---

## Trigger scope

---

Triggers are database wide or specific to a module, object, or attribute. They can be generic or specific.

<b>generic</b>	Trigger applies to all entities at trigger level, for example, all modules, all objects, all attributes.
<b>specific</b>	Trigger applies to a specific entity, for example, module "URD" means the module called <i>URD</i> , <i>current</i> means the current entity (as in <i>current Module</i> ) at a trigger level.

Specific items defined are for each level.

<b>project</b>	project name
<b>module</b>	module name
<b>object</b>	absolute number, as string
<b>attribute</b>	attribute name

Generic module triggers are stored in the specified project or the current project, unless the trigger is specified as database wide using the `project->all` syntax. In this case, they are stored in the database root folder.

### Trigger Example:

Trigger "t1" applies to all modules in the database.

```
trigger("t1", project->all->module->all, pre, open, 10, ...)
```

Trigger "t2" applies to all modules in project "p1".

```
trigger("t2", project->"p1"->module->all, pre, open, 10, ...)
```

Specific module triggers, including all object level and attribute level triggers, are stored in the module to which they apply. If the trigger specification does not name a specific module, they are stored in the current module.

For modules, you can also restrict to a particular type of module: formal, link, or descriptive.

If you want an object trigger to apply only to the current object at definition time, you must give its absolute number as a specific argument:

```
project->module->object->"13"
```

To simplify the notation you can omit mention of the project or module levels when you want the current project or module. The example becomes:

```
attribute->"Cost"
```

In summary, if you do not mention a level, you mean the current position in the Rational DOORS schema at the time of definition.

---

## Trigger events

---

There are seven classes of event, with synonyms:

<b>open, read</b>	Synonyms for the same fundamental event, open is usually used with projects and modules, while read is used with objects.
<b>close</b>	Triggered when Rational DOORS is about to close a project or a module.
<b>write, save, modify</b>	Synonyms for wanting to make a change; currently only supported for attribute modification.
<b>sync</b>	Triggered when the current object changes in a formal module.
<b>drag</b>	Triggered when the user starts a drag operation from a formal module object.
<b>drop</b>	Triggered when data is dragged from another application and dropped onto a displayed formal module object.
<b>create</b>	Applies to discussions and comments, fires on their creation,

If you try to define an unsupported trigger combination, an error message is issued.

---

## Trigger priority

---

Triggers are assigned an integer priority; lower valued priorities are executed before higher valued priorities.

---

## Persistent versus dynamic triggers

---

There are two further classes of trigger:

<b>persistent</b>	Stored in Rational DOORS; once defined, persists between sessions until deleted.
<b>dynamic</b>	Not stored; persists only for the loaded lifetime of the project or module that defines it.

**Note:** In Rational DOORS 8.2 and later versions, drag-and-drop triggers can only be dynamic.

---

## Trigger constants

This section lists constants that are used in the definition of triggers. Some are defined through internal data types; others are of type `TriggerStatus`.

---

## levels

---

A level can be one of the following values:

project  
module  
object  
attribute  
discussion  
comment

---

## level modifiers

---

A level modifier can be one of the following values:

all  
formal  
link  
descriptive

These values specify the type of module affected.

---

## event types

---

An event type can be one of the following values:

pre  
post

---

## event names

---

An event name can be one of the following values:

open  
read  
close  
save  
modify  
sync  
create

---

## Trigger definition

This section defines an operator for assembling triggers and functions for triggers. They use internal data types or the data type `Trigger`.

---

### Trigger level assembly

---

The `->` operator is used to describe the extent to which a trigger is applied:

#### Syntax

The syntax for using the `->` operator is as follows:

```
l -> l2
```

```
l -> mod
```

```
l -> string name -> mod
```

```
l -> string name -> string name2
```

where:

`l l2` are levels: project, module, object or attribute

`name name2` are strings

`mod` is a modifier: all, formal, link, or descriptive

#### Operation

The operator combines trigger level descriptions and specifies the scope of a trigger.

#### Example

- This attribute-level trigger is applied to the `Cost` attribute in the module named `URD` in the current folder:  
`module->"URD"->attribute->"Cost"`
- This module-level trigger is applied to all formal modules in the current project:  
`module->all->formal`  
`project->module->all>formal`  
These level descriptors are invalid if there is no current project.
- This module-level trigger is applied to all formal modules in the database:  
`project->all->module->formal->all`
- This object-level trigger is applied to all formal modules in the `improvements` project:  
`project->"improvements"->module->all->formal->object->all`
- This object-level trigger is applied to the current module:

```
module->object->"23"
```

This level descriptor is invalid if there is no current module.

## trigger(persistent)

### Declaration

```
Trigger trigger(string name,
                l,
                t,
                e,
                int p,
                string dxl)
```

where:

- l* is a level: project, module, object, or attribute
- t* is a type: pre or post
- e* is an event: open, read, close, save, modify or sync
- p* is a priority: indicates the order that similar triggers are executed
- dxl* the dxl code that will be executed by the trigger

### Operation

Creates a trigger, named *name*, at level *l*, of type *t*, of event *e*, with priority *p*, and code *dxl*. If the operation fails, the function returns null. If the user does not have the appropriate modify access, the call fails.

- To create a stored database wide trigger, the user must have modify access to the database root folder.
- To create a trigger stored in a project, the user must have modify access to the project.
- To create a trigger stored in a module, the user must have modify access to the module.

Optionally, the level can be a compound level description.

These triggers are persistent between sessions, and so need be created only once.

### Example

This example creates a project level, pre-type, open event trigger of priority 10, using a program stored in `$DOORSHOME/lib/dxl/triggers/projOpen.dxl`:

```
Trigger t1 = trigger("init", project,
                    pre, open, 10,
                    "#include <triggers/projOpen>")
```

This example sets up a trigger, which is executed when any module is about to be closed:

```
Trigger t2 = trigger("mod", module->all,
                    pre, close, 10,
                    "#include <triggers/modClose>")
```

---

## trigger(dynamic)

---

### Declaration

```
Trigger trigger(l,
               e,
               int p,
               {bool pre(Trigger) |
                void post(Trigger)})
```

where:

- l* is a level: project, module, object, or attribute
- e* is an event: open, read, close, save, modify or sync
- p* is a priority: indicates the order that similar triggers are executed

### Operation

Creates a dynamic trigger, which is not persistent between sessions, at level *l*, of event *e* and priority *p*. The pre callback function determines whether the operation happens or not. The callback function for a post event is a void function.

Optionally, the level can be a compound level description.

---

## delete(trigger)

---

### Declaration

```
string delete(string name,
              l,
              [string name2,]
              t,
              e,
              int p,)
```

```
string delete(Trigger &d)
```

where:

- l* is a level: project, module, object, or attribute
- t* is a type: pre or post
- e* is an event: open, read, close, save, modify or sync
- p* is a priority: indicates the order that similar triggers are executed



## Operation

The first form deletes the specified trigger. The second form deletes trigger *d*, and sets *d* to null. If the operation succeeds, returns null; otherwise, returns an error message. If the user does not have the appropriate modify access, the call fails.

To delete a stored database wide trigger, the user must have modify access to the database root folder. To delete a trigger stored in a project, the user must have modify access to the project. To delete a trigger stored in a module, the user must have modify access to the module.

This example deletes all triggers:

```
Trigger t
for t in current Project do delete t
```

---

## Trigger manipulation

This section defines functions that return information about, or modify triggers.

---

### for trigger in database

---

#### Syntax

```
for t in database do {
  ...
}
```

where:

*t* is a variable of type Trigger

#### Operation

Assigns trigger *t* to be each successive database wide trigger.

---

### for trigger in project

---

#### Syntax

```
for t in project do {
  ...
}
```

where:

*t* is a variable of type Trigger

*project* is a variable of type Project

## Operation

Assigns trigger *t* to be each successive trigger in the specified project, and in any open modules in the project. The appropriate modules in the project must be open to allow access to the relevant trigger information. It includes all subprojects.

## Example

This example deletes all triggers:

```
Trigger t
for t in current Project do delete t
```

## for trigger in module

### Syntax

```
for t in m do {
  ...
}
```

where:

<i>m</i>	is a variable of type Module
<i>t</i>	is a variable of type Trigger

### Operation

Assigns trigger *t* to be each successive trigger in *m*, which must be an open module to allow access to the relevant trigger information.

## level, type, event(trigger)

These functions are used as shown in the following syntax:

```
level(Trigger t)
type(Trigger t)
event(Trigger t)
```

### Operation

These functions return values for the level, type and event of trigger *t*, as follows:

level	project module object attribute
type	pre post
event	open read close save modify sync

---

## stringOf(trigger)

---

These functions are used as shown in the following syntax:

```
string stringOf(level)
```

```
string stringOf(type)
```

```
string stringOf(event)
```

### Operation

Return the string version of trigger level *level*, the trigger type *type*, or trigger event *event*, as follows:

<i>level</i>	project module object attribute
<i>type</i>	pre post
<i>event</i>	open read close save modify sync

---

## attribute(trigger)

---

### Declaration

```
string attribute(Trigger t)
```

### Operation

Returns the name of the attribute to which trigger *t* applies, (if there is one); otherwise, returns null.

---

## attrdef(trigger)

---

### Declaration

```
AttrDef attrdef(Trigger t)
```

### Operation

Returns the name of the attribute about to be saved for attribute pre-save triggers. For pre-open attribute triggers, returns null.

---

## current(trigger)

---

### Declaration

```
Trigger current()
```

### Operation

Gets the current trigger handle in persistent trigger code.

---

## dxl(trigger)

---

### Declaration

```
string dxl(Trigger t)
```

### Operation

Returns the DXL code associated with trigger *t*.

---

## kind

---

### Declaration

```
string kind(Trigger t)
```

### Operation

Returns the kind of trigger *t*: one of `dynamic`, `stored` or `builtin`.

---

## levelModifier

---

### Declaration

```
string levelModifier(Trigger t)
```

### Operation

Returns the module level modifier of trigger *t*, which can be one of the following values:

"F"	formal module
"L"	link module
"D"	descriptive module

---

## name(trigger)

---

### Declaration

```
string name(Trigger t)
```

### Operation

Returns the name of trigger *t*.

---

## object(trigger)

---

### Declaration

```
string object(Trigger t)
Object object(Trigger t)
```

---

## module

---

### Declaration

```
Module module(Trigger t)
string module(Trigger t)
Module module(Trigger t, int unused)
```

### Operation

Fetches the module associated with the specified trigger.

The notion of associated module is as follows:

Trigger	Returns...
Pre-open module and post-close module triggers	Normally a NULL module is returned. When a non-null module is returned, it will be the module against which this trigger last fired.
Post-open module trigger	The current version module or null is returned. When a baseline is opened, this perm will return the current version of the module only when that current version has been separately loaded.
Pre-close module trigger	The current version module or null is returned. When a baseline is closed, this perm will return the current version of the module only when that current version has been separately loaded.
Data-related triggers within a module (object and attribute open/sync, and so on)	The tree where the data resides.  <b>Note:</b> Data with a baseline will return the baseline module.

---

For the following triggers, the associated module is the module containing the data (this will be a baseline when the data is in a baseline):

- object attribute, pre-save
- object attribute, post-save
- link attribute, pre-save

- link attribute, post-save

The third form is as `Module module (Trigger)`, but this variant will return baselined modules when a module-level trigger is running against a baseline of a module. For non-module triggers, the returned module is the same as `Module module (Trigger)`.

The unused integer parameter should be 0.

## version

### Declaration

```
ModuleVersion version(Trigger t)
```

### Operation

Returns the version information pertaining to the specified trigger. The returned value will be null in the case that version information is not appropriate to the trigger.

It is not currently possible to associate a trigger with a specific module version, and thus only executing triggers have an associated version.

## link

### Declaration

```
Link link(Trigger t)
```

### Operation

When a trigger fires because of an operation on a link, for example modification of an attribute) this perm provides access to the corresponding link. In all other cases null is returned.

## value

### Declaration

```
void value(Trigger t, Buffer b)
```

### Operation

Similar to `string value (Trigger)`, but returns in buffer the RTF, inclusive of any OLE objects, of the new value (where that is appropriate).

The creation and deletion of `b` is the responsibility of the user.

## priority

### Declaration

```
int priority(Trigger t)
```

## Operation

Returns the priority of trigger *t*. Lower numbers have higher priority.

## trigger status

A trigger status can be one of the following values:

`trigPreConPass`

`trigPreConFail`

`trigRunOK`

`trigError`

These constants are of type `TriggerStatus`. They are used with the `set` function. They are assigned to persistent pre-event triggers to set a return condition.

## set(trigger status)

### Declaration

```
void set(TriggerStatus ts)
```

### Operation

Sets a return condition in the DXL code assigned to persistent pre-event triggers. Possible values are: `trigPreConPass`, `trigPreConFail`, `trigRunOK`, and `trigError`.

### Example

```
Trigger t1 = trigger("t1", module->object->"1", pre, modify, 10, "#include
<trigger.dxl>")
```

In your `trigger.dxl` code, include one of the following set functions:

- `set(trigPreConPass)` - This causes the event that is associated with the trigger to pass always.
- `set(trigPreConFail)` - This causes the event that is associated with the trigger to fail always.

If the `trigPreConFail` value is used, then the object that is associated with the trigger event cannot be modified.

## stored

### Declaration

```
string stored(Trigger t)
```

### Operation

Returns the name of the module where trigger *t* is stored.

---

## scope

---

### Declaration

```
string scope(Trigger t)
```

```
Item scope(Trigger t)
```

### Operation

Returns the item (or its unqualified name) to which the specified trigger applies. If the item is a project, then the trigger applies to all modules within the project. For static triggers, this returns the same as the stored `()` perm.

---

## value

---

### Declaration

```
string value(Trigger t)
```

### Operation

Similar to `string value(Trigger)`, but returns the value being proposed for attribute modification by trigger `t`.

---

## Triggers review

---

The following tables show what information is available to triggers of various types.



## Dynamic triggers

kind	dynamic	dynamic	dynamic	dynamic	dynamic	dynamic	dynamic	dynamic	dynamic	dynamic
level	module	module	object	object	attribute	module	module	object	object	attribute
type	pre	pre	pre	pre	pre	post	post	post	post	post
event	open	close	open	sync	save	open	close	open	sync	save
priority	yes	yes	yes	yes	yes	yes	yes	yes	yes	yes
attribute	no	no	no	no	yes <sup>1</sup>	no	no	no	no	yes <sup>1</sup>
levelModifier	no	no	no	no	no	no	no	no	no	no
name	yes <sup>2</sup>	yes <sup>2</sup>	yes <sup>2</sup>	yes <sup>2</sup>	yes <sup>2</sup>	yes <sup>2</sup>	yes <sup>2</sup>	yes <sup>2</sup>	yes <sup>2</sup>	yes <sup>2</sup>
string object	no	no	yes	yes	yes	no	no	yes	yes	yes
string module	no	no	no	no	no	no	no	no	no	no
value	no	no	no	no	yes	no	no	no	no	yes
dxi	no	no	no	no	no	no	no	no	no	no
Module module	no	yes	yes	yes	yes	no	yes	yes	yes	yes
Object object	no	no	yes	yes	yes	no	no	yes	yes	yes
attrdef	no	no	no	no	yes	no	no	no	no	yes

<sup>1</sup> Only if trigger is on a named attribute.

<sup>2</sup> Trigger name generated by system

## Persistent triggers

kind	stored	stored	stored	stored	stored	stored	stored	stored	stored	stored
level	module	module	object	object	attribute	module	module	object	object	attribute
type	pre	pre	pre	pre	pre	post	post	post	post	post
event	open	close	open	sync	save	open	close	open	sync	save
priority	yes	yes	yes	yes	yes	yes	yes	yes	yes	yes
attribute	no	no	no	no	yes <sup>3</sup>	no	no	no	no	yes <sup>3</sup>
levelModifier	no	no	no	no	no	no	no	no	no	no
name	yes	yes	yes	yes	yes	yes	yes	yes	yes	yes
string object	no	no	yes	yes	yes	no	no	yes	yes	yes
string module	yes	yes	yes	yes	yes	yes	yes	yes	yes	yes
value	no	no	no	no	yes	no	no	no	no	yes
dxi	yes	yes	yes	yes	yes	yes	yes	yes	yes	yes
Module module	no	yes	yes	yes	yes	no	yes	yes	yes	yes
Object object	no	no	yes	yes	yes	no	no	yes	yes	yes
attrdef	no	no	no	no	yes	no	no	no	no	yes

<sup>3</sup> Only if trigger is on a named attribute

## Drag-and-drop trigger functions

This section defines functions that are used to setup drag or drop trigger callback functions, as well as those functions which can be used within them.

### createDropCallback

#### Declaration

```
void createDropCallback(int fmt, int type, void cb(Trigger), Trigger t)
```

## Operation

When used in a callback for drag trigger *t*, this registers a DXL callback functions *cb* to be run when the drop target application requests data in the specified clipboard format *fmt* and media *type* with a value included in the bitmap value *type*. The *fmt* and *type* argument should match the format of data which is supplied by the callback function using `setDropString()`, `setDropList()` etc.

## registeredFormat

### Declaration

```
int registeredFormat(string formatName)
```

### Operation

Returns the format ID for the specified format name. If the named format has not already been registered, then this perm registers it.

## dropDataAvailable

### Declaration

```
bool dropDataAvailable(format, int type, Trigger t)
```

### Operation

Returns true if dragged data is available in the specified clipboard format, which may be specified as a string registered format name, or a format ID number. The *type* argument is used to specify which media formats should be checked for.

## droppedString

### Declaration

```
string droppedString(format, Trigger t[, bool unicode])
```

### Operation

When used in a callback function for a drop event trigger *t*, this returns any text supplied in the specified clipboard format by the data source application. The *format* argument can be either the name of a registered clipboard format (a string), or a format ID (int). If the *unicode* argument is specified and is true, and the clipboard format is a registered (non-standard) clipboard format, then the string data in the clipboard will be assumed to be in wide-char Unicode format.

## droppedAttrTextAvailable

### Declaration

```
bool droppedAttrTextAvailable(string attr, Trigger t)
```

## Operation

When used in a callback function for a drop event trigger *t*, this function tells whether a dragged text value is available for the named Rational DOORS Object attribute *attr* from the drag source object. Returns true when the drag source is another Rational DOORS client, and the *attr* is an Object attribute in the drag source module whose value can be expressed as a string, and to which the current user in the source has read access.

## droppedAttributeText

### Declaration

```
string droppedAttributeText(string attr, Trigger t)
```

### Operation

When used in a callback function for a drop event trigger *t*, if the drag source is a Rational DOORS client this returns the text form of the named Object attribute *attr*. Returns an empty (null) string when there is no accessible text value corresponding to the named attribute.

## droppedAttrRichTextAvailable

### Declaration

```
bool droppedAttrRichTextAvailable(string attr, Trigger t)
```

### Operation

When used in a callback function for a drop event trigger *t*, this tells whether a dragged Rich Text value (excluding OLE objects) is available for the named Rational DOORS Object attribute *attr* from the drag source object. This returns true when the drag source is another Rational DOORS client, and the named attribute is an Object attribute with base-type Text or String in the drag source module, and to which the current user in the source has read access.

## droppedAttributeRichText

### Declaration

```
string droppedAttributeRichText(string attr, Trigger t)
```

### Operation

When used in a callback function for a drop event trigger *t*, this returns the Rich Text value (excluding OLE objects) of the named Object attribute *attr*, when the drag source is a Rational DOORS client. This returns an empty (null) string when the named attribute is not of base type String or Text.

## droppedAttrOLETextAvailable

### Declaration

```
bool droppedAttrOLETextAvailable(string attr, Trigger t)
```

## Operation

When used in a callback function for a drop event trigger *t*, this tells whether a dragged Rich Text value (including OLE objects) is available for the named Rational DOORS Object attribute *attr* from the drag source object. This returns true when the drag source is another Rational DOORS client, and the named attribute is an Object attribute with base-type Text in the drag source module, and to which the current user in the source has read access.

## droppedAttributeOLEText

### Declaration

```
string droppedAttributeOLEText(string attr, Trigger t)
```

### Operation

When used in a callback function for a drop event trigger *t*, this returns the Rich Text form (including OLE objects) of the named Object attribute *attr*, when the drag source is a Rational DOORS client. This returns an empty (null) string when the named attribute is not of base type Text.

## draggedObjects

### Declaration

```
Skip draggedObjects()
```

### Operation

This returns a Skip list of the objects in the selection where the latest drag has begun. Its return value is only valid within the context of a drag trigger or a drop callback registered by a drag trigger.

## droppedList

### Declaration

```
Skip droppedList(format, Trigger t)
```

### Operation

When used in a callback function for a drop event trigger *t*, this returns any list of strings supplied in the specified clipboard format by the data source application. The *format* argument can be either the name of a registered clipboard format (a string), or a format ID (int).

The data should be supplied as in the standard CF\_HDROP format.

## setDropString

### Declaration

```
string setDropString(int fmt, Trigger t, string s [, bool unicode])
```

## Operation

When used in a callback for a drag trigger *t*, or in a drop callback function registered by `createDropCallback()`, this passes the string *s* to the drop target in the specified clipboard format *fmt*, in TYMED\_HGLOBAL media type. If *fmt* is a non-standard registered clipboard format and *unicode* is specified and is true, then the string data will be supplied in wide-char Unicode format.

Returns null on success, and an error string on failure.

## setDropList

### Declaration

```
string setDropList(int fmt, Trigger t, Skip sk)
```

### Operation

When used in a callback for a drag trigger *t*, or in a drop callback function registered by `createDropCallback()`, this passes the strings in the supplied Skip list to the drop target in the specified clipboard format *fmt*, in TYMED\_HGLOBAL media type, as supplied in the standard CF\_HDROP clipboard format.

Returns null on success, and an error string on failure.

## insertDroppedPicture

### Declaration

```
bool insertDroppedPicture(Object, Trigger t, int fmt[, int type])
```

### Operation

When used in a callback for a drop trigger *t*, and when the specified Object is an editable Picture object, and if picture data is available in the specified format *fmt* and *type*, then this replaces the Object's picture with the picture from the drag source.

If *type* is TYMED\_MFPICT or *fmt* is CF\_METAFILEPICT, then Windows Metafile data will be expected. Otherwise, if *fmt* is CF\_BITMAP then a Device Dependent Bitmap is expected. Otherwise, a Device Independent Bitmap is expected.

The default value for *type* is TYMED\_MFPICT for CF\_METAFILEPICT clipboard format, and TYMED\_GDI for CF\_BITMAP, CF\_DIB and all other formats.

Returns true on success, false on failure.

## saveDroppedPicture

### Declaration

```
bool saveDroppedPicture(Trigger t, string filename, int fmt[, int type])
```

## Operation

When used in a callback for a drop trigger *t*, this saves any picture data available in the specified format *fmt* and data type *type* in the file specified by the full path *filename*.

If *type* is TYMED\_MFPICT or *fmt* is CF\_METAFILEPICT then Windows Metafile data will be expected. Otherwise, if *fmt* is CF\_BITMAP then a Device Dependent Bitmap is expected. Otherwise, a Device Independent Bitmap is expected.

The default value for *type* is TYMED\_MFPICT for CF\_METAFILEPICT clipboard format, and TYMED\_GDI for CF\_BITMAP, CF\_DIB and all other formats.

Returns true on success, false on failure.

## Example

The following two examples, when run in the global context, define drag-and-drop triggers that give some control over the dragging and dropping of data to and from Rational DOORS clients.

### Drag trigger example:

```
/*
    dragTrigger.inc
*/
// Drop callback to supply Object Text in CF_OEMTEXT format.
void dropCB(Trigger t)
{
    Object o = object(t)
    setDropString(CF_OEMTEXT, t, o."Object Text" "")
}

string formatName = "RichEdit Text and Objects"

// Test drop callback
void testCB(Trigger t)
{
    Object o = object(t)
    setDropString(registeredFormat(formatName), t, o."Object Text" "")
}

// Drag trigger: Register callbacks to set CF_OEMTEXT and CF_HDROP
//                format data.
bool preDrag(Trigger t)
```

```

{
    Object o = object(t)
    createDropCallback(CF_OEMTEXT, TYMED_HGGLOBAL, dropCB, t)
    createDropCallback(registeredFormat(formatName), TYMED_HGGLOBAL, testCB, t)
    return true
}

trigger(project->all->module->all->object->all, drag, 1, preDrag)

```

### Drop trigger example:

```

/*
    dropTrigger.inc
*/

// Append registered format drag-drop data info to the buffer for display.
void appendData(Buffer &b, string fmtName, Trigger t, bool unicode)
{
    int tyled
    int types = 0

    for (tyled = TYMED_HGGLOBAL; tyled <= TYMED_ENHMF; tyled *= 2)
    {
        if (dropDataAvailable(fmtName, tyled, t))
        {
            types |= tyled
        }
    }
    if (types > 0)
    {
        int fmt = registeredFormat(fmtName)
        b += fmt " (" fmtName ", " types ") :\n"
        b += " " droppedString(fmtName, t, unicode) "\n"
    }
}

```



```

}

void appendText(Buffer &b, string attrName, bool isSpecial, Trigger t)
{
    if (droppedAttrTextAvailable(attrName,t,isSpecial))
    {
        b += "Attribute Text: " attrName ":\n"
        b += " " droppedAttributeText(attrName,t,isSpecial) "\n"
    }
}

void appendRTF(Buffer &b, string attrName, Trigger t)
{
    if (droppedAttrRichTextAvailable(attrName,t))
    {
        b += "Attribute RichText: " attrName ":\n"
        b += " " droppedAttributeRichText(attrName,t) "\n"
    }
}

void appendOLE(Buffer &b, string attrName, Trigger t)
{
    if (droppedAttrOLETextAvailable(attrName,t))
    {
        b += "Attribute OLE Text: " attrName ":\n"
        b += " " droppedAttributeOLEText(attrName,t) "\n"
    }
}

// Custom trigger: Displays a dialog listing available clipboard formats
// from drag and drop, and displays any string data and list data.
// Prompts the user to insert any available picture-format data if the
// module is open for edit.
bool preDrop(Trigger t)

```

```

{
    if (!confirm("Run custom trigger?"))
    {
        return true
    }
    Buffer b = create
    Object o = object(t)
    int fmt
    int types
    // Check for available data in standard clipboard formats.
    for (fmt = 1; fmt < CF_MAX; fmt++)
    {
        int tyled = TYMED_HGLOBAL
        types = 0
        for (tyled = TYMED_HGLOBAL; tyled <= TYMED_ENHMF; tyled *= 2)
        {
            if (dropDataAvailable(fmt,tyled,t))
            {
                types |= tyled
            }
        }
        if (types > 0)
        {
            b += fmt " (" clipboardFormatName(fmt) ", " types ") :\n"
            if (fmt == CF_HDROP)
            {
                Skip skp = droppedList(fmt,t)
                string s
                for s in skp do
                {
                    b += " - " s "\n"
                }
                delete skp
            }
        }
    }
}

```

```

else if (fmt == CF_DIB || fmt == CF_BITMAP || fmt == CF_METAFILEPICT)
{
    if (isEdit(module o) && confirm("Insert picture format "
clipboardFormatName(fmt) "?"))
    {
        if (formatUNKNOWN != getPictFormat(o))
        {
            // Dropping onto a picture object -
            // replace the existing picture
            insertDroppedPicture(o,t,fmt)
            refresh(module o)
        }
    }
else
{
    // Not a picture object: append a new one.
    string filename = tempFileName()
    int tymed = TYMED_GDI
    int picFmt = formatBMP
    if (fmt == CF_METAFILEPICT)
    {
        tymed = TYMED_MFPICT
        picFmt = formatWMF
    }
    if (saveDroppedPicture(t, filename, fmt, tymed))
    {
        insertPictureFileAfter(filename, picFmt, o)
        deleteFile(filename)
        refresh(module o)
    }
}
}
else
{

```

```

        b += " " droppedString(fmt,t) "\n"
    }
}

if (droppedAttrTextAvailable("Object Heading",t))
{
    if (confirm("Replace Object Heading?"))
    {
        o."Object Heading" = droppedAttributeText("Object Heading",t)
    }
}

if (droppedAttrRichTextAvailable("Object Text",t))
{
    if (confirm("Replace Object Rich Text?"))
    {
        o."Object Text" = droppedAttributeRichText("Object Text",t)
    }
}

if (droppedAttrOLETextAvailable("Object Text",t))
{
    if (confirm("Replace Object Rich Text with OLE?"))
    {
        o."Object Text" = droppedAttributeOLEText("Object Text",t)
    }
}

// Check for specific registered clipboard formats.
appendData(b,"DOORS Object URL",t,false)
appendData(b,"RichEdit Text and Objects",t,false)
appendText(b,"Object Heading",false,t)
appendText(b,"Object Text",false,t)
appendText(b,"Last Modified Time",true,t)

```

```
appendData(b,"UniformResourceLocator",t,false)
b += "\nonto Object " o."Absolute Number" ""

// Display the results.
DB thedb = create (module(o), "Dropped data")
DBE thetext = text(thedb,"",stringOf(b),200,true)
block thedb
destroy thedb
delete b
return false
}

trigger(project->all->module->all->object->all,drop,1,preDrop)
```



## Chapter 30

# Page setup functions

This chapter describes the page setup functions.

- Page attributes status
- Page dimensions
- Document attributes
- Page setup information
- Page setup management

---

## Page attributes status

This section describes the page setup functions that return the status of a page attribute or set it. They are intended for use in exporters.

In each case there are two versions of the function that gets the status of a page attribute: one for a specific page; the other with no page specified, which operates on the current page. Similarly, there are two versions of each function that sets the status of a page attribute. The functions that get or set data for a specific page use the data type `PageLayout`.

---

## Get page properties status

---

### Declaration

```
bool pageChangeBars([PageLayout myPageSetup])
bool pagePortrait([PageLayout myPageSetup])
bool pageRepeatTitles([PageLayout myPageSetup])
bool pageTitlePage([PageLayout myPageSetup])
```

where:

*myPageSetup*      Specifies a page setup

### Operation

Returns `true` for the properties described below on *myPageSetup*, or if *myPageSetup* is omitted, on the current page; otherwise, it returns `false`.

<code>pageChangeBars</code>	Shows change bars
<code>pagePortrait</code>	Is portrait

<code>pageRepeatTitles</code>	Repeats titles on every page
<code>pageTitlePage</code>	Shows a title page

---

## Set page properties status

---

### Declaration

```
bool pageChangeBars ([PageLayout myPageSetup, ]
                    bool expression)

bool pagePortrait ([PageLayout myPageSetup, ]
                 bool expression)

bool pageRepeatTitles ([PageLayout myPageSetup, ]
                      bool expression)

bool pageTitlePage ([PageLayout myPageSetup, ]
                  bool expression)
```

where:

<i>myPageSetup</i>	Specifies a page setup
<i>expression</i>	Is an expression

### Operation

Sets the properties described below on *myPageSetup*, or if *myPageSetup* is omitted, on the current page. Returns `true` if the operation succeeds; otherwise, returns `false`.

Argument expression	Evaluates true	Evaluates false
<code>pageChangeBars</code>	Shows change bars	Hides change bars
<code>pagePortrait</code>	Sets portrait	Sets landscape
<code>pageRepeatTitles</code>	Repeats titles on every page	Shows titles on first page only
<code>pageTitlePage</code>	Shows a title page	Suppresses a title page

---

## Page dimensions

This section describes the page setup functions that return or set the size of a page dimension.

In each case there are two versions of the function that gets the size of a page dimension: one for a specific page; the other with no page specified, which operates on the current page. Similarly, there are two versions of each function that sets the size of a page dimension. The functions that get or set dimensions for a specific page use the data type `PageLayout`.



---

## Get page dimension

---

### Declaration

```
int pageSize([PageLayout myPageSetup])
int pageWidth([PageLayout myPageSetup])
int pageHeight([PageLayout myPageSetup])
int pageTopMargin([PageLayout myPageSetup])
int pageBottomMargin([PageLayout myPageSetup])
int pageLeftMargin([PageLayout myPageSetup])
int pageRightMargin([PageLayout myPageSetup])
```

where:

*myPageSetup*            Specifies a page setup

### Operation

Returns the size as described below on *myPageSetup*, or if *myPageSetup* is omitted, on the current page.

<code>pageSize</code>	Page size indicated by 0 (A4), 1 (A3), 2 (A5), 3 (legal), 4 (letter), 5 (custom)
<code>pageWidth</code>	Page width in mm
<code>pageHeight</code>	Page height in mm
<code>pageTopMargin</code>	Top margin in mm
<code>pageBottomMargin</code>	Bottom margin in mm
<code>pageLeftMargin</code>	Left margin in mm
<code>pageRightMargin</code>	Right margin in mm

---

## Set page dimension

---

### Declaration

```
bool pageSize([PageLayout myPageSetup, ]
              int dimension)
bool pageWidth([PageLayout myPageSetup, ]
              int dimension)
bool pageHeight([PageLayout myPageSetup, ]
               int dimension)
```

```

bool pageTopMargin([PageLayout myPageSetup, ]
                  int dimension)

bool pageBottomMargin([PageLayout myPageSetup, ]
                     int dimension)

bool pageLeftMargin([PageLayout myPageSetup, ]
                   int dimension)

bool pageRightMargin([PageLayout myPageSetup, ]
                    int dimension)

```

where:

<i>myPageSetup</i>	Specifies a page setup
<i>dimension</i>	Specifies a dimension

## Operation

Sets the size of the dimension described below on *myPageSetup*, or if *myPageSetup* is omitted, on the current page. Returns true if the operation succeeds; otherwise, returns false.

<i>pageSize</i>	Page size indicated by 0 (A4), 1 (A3), 2 (A5), 3 (legal), 4 (letter), 5 (custom)
<i>pageHeight</i>	Page height in mm
<i>pageWidth</i>	Page width in mm
<i>pageTopMargin</i>	Top margin in mm
<i>pageBottomMargin</i>	Bottom margin in mm
<i>pageLeftMargin</i>	Left margin in mm
<i>pageRightMargin</i>	Right margin in mm

## Example

```

const int paperA4 = 0,
       paperA3 = 1,
       paperA5 = 2,
       paperLegal = 3,
       paperLetter = 4,
       paperCustom = 5

if (pageSize == paperCustom) {
    // do something specific
}

```

---

## Document attributes

This section describes the page setup functions that return or set a document attribute. These are features of a complete document rather than a page.

For `pageBreakLevel`, `pageTOCLevel` and `pageHeaderFooter`, there are two versions of the function that gets the document attribute: one for a specific page; the other with no page specified, which operates on the current page. Similarly, there are two versions of these functions that set the document attribute. The functions that get or set data for a specific page use the data type `PageLayout`. Note that a statement such as `'pageBreakLevel = 1'` is not supported.

---

### `pageBreakLevel`, `pageTOCLevel(get)`

---

#### Declaration

```
int pageBreakLevel([PageLayout myPageSetup])
```

```
int pageTOCLevel([PageLayout myPageSetup])
```

where:

*myPageSetup*            Specifies a page setup

#### Operation

Returns the document attribute as described below on *myPageSetup*, or if *myPageSetup* is omitted, on the current page.

`pageBreakLevel`            Heading level at which a page break is automatically inserted

`pageTOCLevel`            Lowest heading level included in table of contents

---

### `pageBreakLevel`, `pageTOCLevel(set)`

---

#### Declaration

```
bool pageBreakLevel([PageLayout myPageSetup, ]
                    int level)
```

```
bool pageTOCLevel([PageLayout myPageSetup, ]
                  int level)
```

where:

*myPageSetup*            Specifies a page setup

*level*                    Specifies a level

## Operation

Sets the document attribute described below on *myPageSetup*, or if *myPageSetup* is omitted, on the current page. Returns `true` if the operation succeeds; otherwise, returns `false`.

<code>pageBreakLevel</code>	Heading level at which a page break is automatically inserted
<code>pageTOCLevel</code>	Lowest heading level included in table of contents

---

## pageHeaderFooter(get)

---

### Declaration

```
string pageHeaderFooter([PageLayout myPageSetup,
                        int fieldNumber)
```

where:

<i>myPageSetup</i>	Specifies a page setup
<i>fieldNumber</i>	Identifies a header or footer field

### Operation

Returns the header or footer string defined for *myPageSetup*, or if *myPageSetup* is omitted, for the current page, as follows:

	<i>fieldNumber</i> for page type		
	<b>body</b>	<b>contents</b>	<b>title</b>
left header	0	6	12
center header	1	7	13
right header	2	8	14
left footer	3	9	15
center footer	4	10	16
right footer	5	11	17

---

## pageHeaderFooter(set)

---

### Declaration

```
bool pageHeaderFooter([PageLayout myPageSetup,
                      int fieldNumber, string s)
```

where:

<i>myPageSetup</i>	Specifies a page setup
<i>fieldNumber</i>	Identifies a header or footer field
<i>s</i>	Is the string to be placed in the specified field

## Operation

Places the header or footer string in the specified field (see the `pageHeaderFooter (get)` function) on `myPageSetup`, or if `myPageSetup` is omitted, on the current page. Returns `true` if the operation succeeds; otherwise, returns `false`.

---

## pageExpandHF

---

### Declaration

```
string pageExpandHF(string HF,
                   string thisPage,
                   string maxPage)
```

### Operation

Takes a header or footer string, *HF*, a current page number as a string, and a maximum page number as a string, and returns the string to be printed. Page numbers are passed as strings to permit roman and other numerals.

Typically, the *HF* value is returned from the `pageHeaderFooter (get)` function.

The options are:

&N	Current page number, for a contents page in Roman numerals; not available on a title page
&C	Total page count; not available for title page or contents pages
&M	Current module name
&P	Project name
&V	Current version of module
&U	User name
&D	Session date
&T	Time of printing
&A	Rational DOORS product name
&B	Rational DOORS product version

## Example

This example prints Page 1 of 10:

```
print pageExpandHF("Page &N of &C", "1", "10")
```

---

## Page setup information

This section describes the page setup functions that return or set specific information.

For `pageColumns`, and `pageFormat`, there are two versions of the function that gets the layout information: one for a specific page; the other with no page specified, which operates on the current page. Similarly, there are two versions of each function that sets the layout information. The functions that get or set layout information for a specific page use the data type `PageLayout`.

---

## Setting current page setup

The assignment operator `=` can be used as shown in the following syntax:

```
current = PageLayout setup
```

Makes `setup` the current page setup, provided the user has read access to the page setup. See also, the `current (page setup)` function.

For large DXL programs, when you set the current page setup, cast the current on the left hand side of the assignment to the correct type. This speeds up the parsing of the DXL program, so when your program is first run, it is loaded into memory quicker. It does not affect the subsequent execution of your program. So:

```
current = newCurrentPageSetup
```

becomes

```
(current ModuleRef__) = newCurrentPageSetup
```

Note that this cast only works for assignments to `current`. It is not useful for comparisons or getting the value of the current page setup.

---

## current(page setup)

### Declaration

```
PageLayout current()
```

### Operation

Returns the current page setup.

---

## pageColumns, pageFormat(get)

---

### Declaration

```
int pageColumns([PageLayout myPageSetup])
int pageFormat([PageLayout myPageSetup])
where:
```

*myPageSetup*      Specifies a page setup

### Operation

Returns the information described below on *myPageSetup*, or if *myPageSetup* is omitted, on the current page.

<code>pageColumns</code>	Column style indicated by 0 (filled), 1 (table), 2 (not marked)
<code>pageFormat</code>	Page format indicated by 0 (columns), 1 (book)

---

## pageColumns, pageFormat(set)

---

### Declaration

```
bool pageColumns([PageLayout myPageSetup,]
                 int style)
bool pageFormat([PageLayout myPageSetup,]
               int style)
where:
```

*myPageSetup*      Specifies a page setup

*style*              Specifies a style

### Operation

Sets the information described below on *myPageSetup*, or if *myPageSetup* is omitted, on the current page. Returns `true` if the operation succeeds; otherwise, returns `false`.

<code>pageColumns</code>	Column style indicated by 0 (filled), 1 (table), 2 (not marked)
<code>pageFormat</code>	Page format indicated by 0 (columns), 1 (book)

---

## pageTitlePage

---

### Declaration

```
bool pageTitlePage()
bool pageTitlePage(PageLayout)
```

### Operation

These functions allow the user to get the signature page setting for either the current page layout or the specified one.

---

## pageSignaturePage

---

### Declaration

```
bool pageSignaturePage(bool)
bool pageSignaturePage(PageLayout, bool)
```

### Operation

These functions allow the user to set the signature page setting for either the current page layout or the specified one.

---

## pageIncludeFilters

---

### Declaration

```
bool pageIncludeFilters([PageLayout][, bool])
```

### Operation

These functions allow the user to either set the **Include filter criteria on title page** setting, or, if a boolean parameter is not supplied, obtain the current setting.

If a `PageLayout` is not supplied, the operation will be performed on the current `PageLayout`.

---

## pageIncludeSort

---

### Declaration

```
bool pageIncludeSort([PageLayout][, bool])
```

### Operation

These functions allow the user to either set the **Include sort criteria on title page** setting, or, if a boolean parameter is not supplied, obtain the current setting.

If a `PageLayout` is not supplied, the operation will be performed on the current `PageLayout`.



---

## Page setup management

This section defines the functions that allow you to manage page setups.

---

### create

---

#### Declaration

```
PageLayout create(string myPageSetup)
```

#### Operation

Creates the page setup *myPageSetup*.

---

### delete

---

#### Declaration

```
bool delete(PageLayout myPageSetup)
```

#### Operation

Deletes the page setup *myPageSetup*. Returns `true` if the operation succeeds; otherwise, returns `false`.

---

### isValidName

---

See “`isValidName`,” on page 296.

---

### pageLayout

---

#### Declaration

```
PageLayout pageLayout(string myPageSetup)
```

#### Operation

Returns the page setup of *myPageSetup*.

---

### pageName

---

#### Declaration

```
string pageName([PageLayout myPageSetup])
```

#### Operation

Returns the name of the page setup *myPageSetup*, or if *myPageSetup* is omitted, of the current page.

---

## save(page setup)

---

### Declaration

```
bool save(PageLayout myPageSetup)
```

### Operation

Saves the page setup *myPageSetup*. Returns `true` if the operation succeeds; otherwise, returns `false`.

---

## for setup name in setups

---

### Syntax

```
for setupName in pageSetups database do {  
    ...  
}
```

where:

```
setupName    is a string variable
```

### Operation

Assigns the string *setupName* to be each successive page setup name found in the database.

### Example

```
string setupName  
for setupName in pageSetups database do {  
    print setupName "\n"  
}
```

## Chapter 31

# Tables

This chapter describes the table handling functions, many of which are useful for making exporters.

- Table concept
- Table constants
- Table management
- Table manipulation
- Table attributes

---

## Table concept

In Rational DOORS, a table is an object hierarchy displayed in the form of a table.

The table's top level is referred to as the table header object; for each row it has a sub-object, called a row object. These row objects, in turn, have sub-objects, which are the table cells.

---

## Table constants

You can use the column alignment constants of type `Justification` for tables. For further information, see “Column alignment constants,” on page 686.

You define table borders using constants of type `TableBorderStyle` and `TableBorderPosition`.

### Declaration

```
const TableBorderStyle noborder
const TableBorderStyle solidBorder
const TableBorderStyle dottedborder
const TableBorderPosition left
const TableBorderPosition right
const TableBorderPosition top
const TableBorderPosition bottom
```

### Operation

These constants are used to define tables with the `setCellBorder` and `setAllCellsBorder` functions.

---

## Table management

This section defines the table management functions.

---

### table(create)

---

#### Declaration

```
Object table(Module m,
             int rows,
             int cols)

Object table(Object o,
             int rows,
             int cols)

Object table(before(Object o),
             int rows,
             int cols)

Object table(below(Object o),
             int rows,
             int cols)

Object table(last(below(Object o)),
             int rows,
             int cols)
```

#### Operation

The first form creates a table of size *rows*, *cols* as the first object in a module.

The second form creates a table of size *rows*, *cols* at the same level and immediately after object *o*.

The third form creates a table of size *rows*, *cols* at the same level and immediately before the object *o*.

The fourth form creates a table of size *rows*, *cols* as the first child of the object *o*.

The fifth form creates a table of size *rows*, *cols* as the last child of the object *o*.

#### Example

```
// create as first object
Object params = table(current Module, 10, 3)

// create at same level and after object
Object analysis = table(current object, 4, 4)

// create at same level and before object
Object revisions = table(before first current,
                        noOfChanges, 3)
```

```
// create as first child
Object wordCount = table(below checkedObject,
                        noOfWords, 2)
```

---

## table

---

### Declaration

```
bool table(Object o)
```

### Operation

Returns `true` if `o` is a table header object; otherwise, returns `false`.

Use this function in an exporter that does not handle tables.

---

## row

---

### Declaration

```
bool row(Object o)
```

### Operation

Returns `true` if `o` is a row header object; otherwise, returns `false`.

---

## cell

---

### Declaration

```
bool cell(Object o)
```

### Operation

Returns `true` if `o` is a table cell; otherwise, returns `false`.

---

## tableContents(get)

---

### Declaration

```
bool tableContents(Module m)
```

### Operation

Gets the status of tables in the specified module. It returns `true` for tables shown or `false` for tables hidden.

## Example

```
if (tableContents current Module &&
    table current Object) {
    dumpTable(current, outputStream)
}
```

---

## tableContents(set)

---

### Declaration

```
void tableContents(bool expression)
```

### Operation

Shows or hides tables in the current module, if *expression* evaluates to true or false, respectively.

---

## deleteCell, deleteColumn, deleteRow, deleteTable

---

### Declaration

```
string deleteCell(Object tableCell)
string deleteColumn(Object tableCell)
string deleteRow(Object tableCell)
string deleteTable(Object tableObj)
```

### Operation

Deletes the cell, column, row, or table containing *tableCell*, which must be a table cell.

If successful, returns a null string. Otherwise, returns an error message. If the object is not a table cell, the call fails but no error is reported.

---

## undeleteCell, undeleteColumn, undeleteRow, undeleteTable

---

### Declaration

```
string undeleteCell(Object tableCell)
string undeleteColumn(Object tableCell)
string undeleteRow(Object tableCell)
string undeleteTable(Object tableObj)
```

### Operation

Undeletes the cell, column, row, or table containing *tableCell*, which must be a table cell.

If successful, returns a null string. Otherwise, returns an error message. If the object is not a table cell, the call fails but no error is reported.

---

## for row in table

---

### Syntax

```
for ro in table(Object o) do {
  ...
}
```

where:

*ro* is a row variable of type *Object*  
*o* is an object of type *Object*

### Operation

Assigns the cell variable *ro* to be each successive table row, returning row objects, which can be passed to the `for cell` in row loop.

---

## for cell in row

---

### Syntax

```
for co in row(Object o) do {
  ...
}
```

where:

*co* Is a cell variable of type *Object*  
*o* Is an object of type *Object*

### Operation

Assigns the cell variable *co* to be each successive row cell.

This loop returns all cells in a row regardless of whether they are displayed (filtered or deleted).

To only return cells in the current display set, test each cell using `isVisible(Object o)`.

### Example 1

This outputs the identifiers of the table cells in the current table.

```
Object rowHead
for rowHead in table current Object do {
  Object cell
```

```

        for cell in row rowHead do {
            print identifier cell "\n"
        }
    }

```

## Example 2

This outputs the identifiers of the table cells in the current display set.

```

Object rowHead
for rowHead in table current Object do {
    Object cell
    for cell in row rowHead do {
        if (isVisible cell)
            print identifier cell "\n"
    }
}
}

```

---

## Table manipulation

This section defines functions for editing and manipulating tables.

---

### appendCell

---

#### Declaration

```
Object appendCell(Object tableCell)
```

#### Operation

Appends a table cell after the given object, which must be a table cell.

If the user does not have permission to create cells, or the specified object is not a table cell, a run-time error occurs.

---

### appendColumn(table)

---

#### Declaration

```
Object appendColumn(Object tableCell)
```

#### Operation

Appends a table column after the given object, which must be a table cell.

If the user does not have permission to create columns, or the specified object is not a table cell, a run-time error occurs.



---

## appendRow

---

### Declaration

```
Object appendRow(Object tableCell)
```

### Operation

Appends a table row after the given object, which must be a table cell.

If the user does not have permission to create rows, or the specified object is not a table cell, a run-time error occurs.

---

## insertCell

---

### Declaration

```
Object insertCell(Object tableCell)
```

### Operation

Inserts a table cell before the given object, which must be a table cell.

### Example

```
Object o = current Object
if (cell o) {
    Object newCell = insertCell o
    newCell."Object Text" = "New cell"
} else {
    ack "current object is not a cell"
}
```

---

## insertColumn(table)

---

### Declaration

```
Object insertColumn(Object tableCell)
```

### Operation

Inserts a table column before the given object, which must be a table cell.

### Example

```
Object o = current Object
```

```

if (cell o) {
    Object newColumn = insertColumn o
    newColumn."Object Text" = "New column"
} else {
    ack "current object is not a column"
}

```

---

## insertRow

---

### Declaration

```
Object insertRow(Object tableCell)
```

### Operation

Inserts a table row above the given object, which must be a table cell.

### Example

```

Object o = current Object
if (cell o) {
    Object newRow = insertRow o
    newRow."Object Text" = "New row"
} else {
    ack "current object is not a row"
}

```

---

## getTable

---

### Declaration

```
Object getTable(Object tableCell)
```

### Operation

Returns the header object of the table containing *tableCell*. This object is not visible. It is used in calls to functions that set all the cells in a table.

---

## getRow

---

### Declaration

```
Object getRow(Object tableCell)
```

### Operation

Returns the header object of the row containing *tableCell*. This object is not visible. It is used when you want to do something to all the objects in a row.

## Example

```
Object tableCell
Object rowObject = getRow(aCellIntheRow)
for tableCell in rowObject do{
    // do something to the cell
}
```

---

## getCellAlignment

---

### Declaration

Justification  
 getCellAlignment(Object *tableObject*)

### Operation

Returns the alignment of cells in *tableObject*.

---

## getCellWidth

---

### Declaration

int getCellWidth(Object *tableCell*)

### Operation

Returns the width in pixels of *tableCell*.

---

## getCellShowChangeBars

---

### Declaration

bool getCellShowChangeBars(Object *tableCell*)

### Operation

If *tableCell* is set to show change bars, returns true; otherwise, returns false.

---

## getCellShowLinkArrows

---

### Declaration

bool getCellShowLinkArrows(Object *tableCell*)

### Operation

If *tableCell* is set to show link arrows, returns true; otherwise, returns false.

---

## getShowTableAcrossModule

---

### Declaration

```
bool getShowTableAcrossModule(Object tableCell)
```

### Operation

If *tableCell* is set to show the table across the module, instead of just in the main column, returns `true`; otherwise, returns `false`.

---

## setAllCellsAlignment

---

### Declaration

```
void
setAllCellsAlignment(Object tableObject,
                    Justification alignment)
```

### Operation

Sets all cells alignment within *tableObject* to have *alignment*. The *tableObject* argument must be the object returned by a call to the `getTable` function.

---

## setAllCellsBorder

---

### Declaration

```
void setAllCellsBorder(Object tableObject,
                      TableBorderPosition edge,
                      TableBorderStyle style)
```

### Operation

Sets all specified border edges within *tableObject* to have the specified style.

---

## setAllCellsShowChangeBars

---

### Declaration

```
void
setAllCellsShowChangeBars(Object tableObject,
                          bool show)
```

### Operation

If *show* is `true`, sets the all the cells in *tableObject* to show change bars. Otherwise, sets all the cells to hide change bars. The *tableObject* argument must be the object returned by a call to the `getTable` function.

---

## setAllCellsShowLinkArrows

---

### Declaration

```
void  
setAllCellsShowLinkArrows(Object tableObject,  
                           bool show)
```

### Operation

If *show* is true, sets the all the cells in *tableObject* to show link arrows. Otherwise, sets all the cells to hide link arrows. The *tableObject* argument must be the object returned by a call to the `getTable` function.

---

## setAllCellsWidth

---

### Declaration

```
void setAllCellsWidth(Object tableObject,  
                      int width)
```

### Operation

Sets all the cells in *tableObject* to have *width* in pixels. The *tableObject* argument must be the object returned by a call to the `getTable` function.

---

## setCellAlignment

---

### Declaration

```
void setCellAlignment(Object tableCell,  
                      Justification alignment)
```

### Operation

Sets cell alignment within *tableCell* to have *alignment*.

---

## setCellBorder

---

### Declaration

```
void setCellBorder(Object tableCell,  
                  TableBorderPosition edge  
                  TableBorderStyle style)
```

### Operation

Sets the specified border edge to the specified style on the given cell.

---

## setCellShowChangeBars

---

### Declaration

```
void setCellShowChangeBars (Object tableCell,  
                             bool show)
```

### Operation

If *show* is `true`, sets the cell containing *tableCell* to show change bars. Otherwise, sets the cell to hide change bars.

---

## setCellShowLinkArrows

---

### Declaration

```
void setCellShowLinkArrows (Object tableCell,  
                             bool show)
```

### Operation

If *show* is `true`, sets the cell containing *tableCell* to show link arrows. Otherwise, sets the cell to hide link arrows.

---

## setCellWidth

---

### Declaration

```
void setCellWidth (Object tableCell,  
                  int width)
```

### Operation

Sets the cell containing *tableCell* to have *width* in pixels.

---

## setColumnAlignment

---

### Declaration

```
void setColumnAlignment (Object tableCell,  
                         Justification alignment)
```

### Operation

Sets the column containing *tableCell* to have *alignment*.

---

## setColumnShowChangeBars

---

### Declaration

```
void setColumnShowChangeBars(Object tableCell,
                              bool show)
```

### Operation

If *show* is true, sets the column containing *tableCell* to show change bars. Otherwise, sets the column to hide change bars.

---

## setColumnShowLinkArrows

---

### Declaration

```
void setColumnShowLinkArrows(Object tableCell,
                              bool show)
```

### Operation

If *show* is true, sets the column containing *tableCell* to show link arrows. Otherwise, sets the column to hide link arrows.

---

## setColumnWidth

---

### Declaration

```
void setColumnWidth(Object tableCell,
                    int width)
```

### Operation

Sets the column containing *tableCell* to have *width* in pixels.

---

## setRowWidth

---

### Declaration

```
void setRowWidth(Object tableCell,
                 int width)
```

### Operation

Sets the row containing *tableCell* to have *width* in pixels.

---

## setShowTableAcrossModule

---

### Declaration

```
void setShowTableAcrossModule(Object tableCell,
                               bool showTable)
```

### Operation

If *showTable* is true, sets the table containing *tableCell* to show the table across the module, instead of just in the main column. Otherwise, sets the table not to show across the module.

---

## toTable

---

### Declaration

```
void toTable(Object header)
```

### Operation

Converts a three-level object hierarchy into a table.

### Example

This loop function detects objects that have been imported from an imaginary format called XYZ as Rational DOORS 3.0 tables, and converts them into Rational DOORS native tables.

```
Object o = first current Module
while (!null o) {
    string importType = o."XYZ Type"
    if (!table o) {
        if (importType == "Table") {
            toTable o
            o = next sibling o
        } else {
            o = next o
        }
    }
}
```

---

## Table attributes

This section defines the functions which deal with the attributes shown in tables.

Note that the display of attributes in tables objects is controlled through the reserved “Main Column Attribute” attribute. Values of which can be assigned or obtained as per normal attributes, but with the addition of the “reserved” keyword e.g. `Object.(reserved "Main Column Attribute") = "Object Heading"`



---

## useDefaultTableAttribute

---

### Declaration

```
bool useDefaultTableAttribute(ViewDef vd)
void useDefaultTableAttribute(ViewDef vd, bool setting)
```

### Operation

The first form returns true if the default table attribute is being used in the given view, otherwise it returns false. The second form turns the use of the default table attribute in the given view on or off.

---

## enableDefaultTableAttribute

---

### Declaration

```
void enableDefaultTableAttribute(bool setting)
bool enableDefaultTableAttribute(Module)
```

### Operation

The first form enables or disables the ability to specify a default table attribute in the current module. The second form returns true if the use of a default table attribute is enabled in the given module, otherwise it returns false.

---

## overrideTableAttribute

---

### Declaration

```
void overrideTableAttribute(bool setting)
bool overrideTableAttribute(Module)
```

### Operation

The first form sets a flag indicating that the specified default attribute for the current module should override the display attribute for all tables in the module. Setting this value will have no effect if the Default Table Attribute option is not enabled. The second form returns true if the Override Table Attribute option is enabled in the given module, otherwise it returns false.

---

## defaultTableAttribute

---

### Declaration

```
void defaultTableAttribute(string AttrName)
string defaultTableAttribute(Module)
```

## Operation

The first form sets the default table cell attribute on the current module. If the name provided is not a valid attribute name, then the default “Main Column” will be displayed. Setting this value will have no effect if the Default Table Attribute option is not enabled. The second form returns the name of the Default Table Attribute for the given module.

## Example

```
//This example re-saves the current view having set the default table attribute
//to be the Object Heading, with some verification along the way.
string curViewName = currentView (current Module)
View curView = view curViewName
ViewDef vd = get curView
string MyDefTableAttr = "Object Heading"

if (!enableDefaultTableAttribute (current Module)){
    enableDefaultTableAttribute (true)
}

defaultTableAttribute (MyDefTableAttr)

if (defaultTableAttribute (current Module) != MyDefTableAttr){
    print "An error occurred setting the default table attribute.\n"
} else {
    useDefaultTableAttribute (vd, true)

    if (!useDefaultTableAttribute (vd)){
        print "An error occurred while activating the default table attribute on
the current view."
    } else {
        save (curView, vd)
    }
}
}
```

## Chapter 32

# Rich text

This chapter describes the functions that allow manipulation of rich text.

- Rich text processing
- Rich text strings
- Enhanced character support
- Importing rich text
- Diagnostic perms

---

## Rich text processing

This section gives the syntax for operators, functions and a `for` loop, which can be used to process rich text. These elements use internal data types, so declarations are not stated.

A rich text string contains sections of formatting, referred to as **chunks**. Each chunk can be processed using the core `for` loop that performs the decomposition. Chunks are processed as variables of type `RichText`, from which different properties can be extracted.

These decomposition functions are particularly valuable for implementing exporters that have to generate formatting information.

---

## Rich text tags

The following tags can be used in DXL code to create rich text strings:

<code>\b</code>	bold text
<code>\i</code>	italic text
<code>\ul</code>	underlined text
<code>\strike</code>	struck through text
<code>\sub</code>	subscript text
<code>\super</code>	superscript text
<code>\nosubersub</code>	neither subscript nor superscript

The syntax for using these tags within a string is as follows:

```
{tag<space>text}
```

or

```
{tag{text}}
```

Tags can be nested, to apply more than one type of formatting, as follows:

```
{tag<space>text {tag<space>text}}
```

**Note:** Remember that the back-slash character (\) must be escaped with another back-slash character in a string.

## Rich text constructors

The dot operator (.) is used to extract information from rich text chunks.

### Syntax

```
richString.richTextProperty
```

where:

*richString* Is a chunk of rich text of type `RichText`

*richTextProperty* Is one of the properties described below

### Operation

The properties act on the chunk of rich text as follows:

String property	Extracts
<code>text</code>	The text of a chunk of rich text as a string without formatting

Boolean property	Extracts
<code>bold</code>	Whether the chunk of rich text has bold formatting
<code>last</code>	Whether the chunk of rich text is the last in the string
<code>italic</code>	Whether the chunk of rich text has italic formatting
<code>newline</code>	Whether the chunk of rich text is immediately followed by a newline character
<code>strikethru</code>	Whether the chunk of rich text has strike through formatting
<code>subscript</code>	Whether the chunk of rich text has subscript formatting

Boolean property	Extracts
<code>superscript</code>	Whether the chunk of rich text that has superscript formatting
<code>underline</code>	Whether the chunk of rich text that has underline formatting

For examples, see the `for rich text in string` loop.

---

## `richText(column)`

---

### Declaration

```
string richText(Column c,
                Object o)
```

### Operation

Returns the text contained in column `c` for the object `o` as rich text.

---

## `richTextWithOle(column)`

---

### Declaration

```
string richTextWithOle(Column c, Object o)
```

### Operation

Returns the text contained in column `c` for the object `o` as rich text, including OLE objects.

---

## `richTextWithOleNoCache(column)`

---

### Declaration

```
string richTextWithOleNoCache(Column c, Object o)
```

### Operation

Returns the text contained in column `c` for the object `o` as rich text, including OLE objects, and clears the OLE cache.

---

## `richTextNoOle(column)`

---

### Declaration

```
string richTextNoOle(Column c, Object o)
```

## Operation

Returns the text contained in column *c* for the object *o* as rich text, excluding OLE objects.

## removeUnlistedRichText

### Declaration

```
string removeUnlistedRichText(string s)
```

### Operation

Removes rich text markup that Rational DOORS does not recognize. Fonts are preserved when importing Word or RTF documents. Fonts can be specified by inserting a symbol from a specific font.

### Example

This example prints `{\b bold text}` in the DXL Interaction window's output pane:

```
string s = "{\\b \\unknown bold text}"
print removeUnlistedRichText s
```

## for rich text in string

### Syntax

```
for rt in string s do {
  ...
}
```

where:

<i>rt</i>	is a variable of type RichText
<i>s</i>	is a string containing valid rich text

### Operation

Assigns the rich text variable *rt* to be each successive chunk of formatting in a rich text string, returning each as a pointer to a structure of type RichText. This structure can tell you whether a piece of text is bold, italic, underlined, struck through, subscript, superscript, or at the end of a line.

### Example

```
string s = "{\\b Bold}{\\i Italic}DXL"
RichText rt
for rt in s do {
  if (rt.italic) print rt.text " is italic\n"
  else
    if (rt.bold) print rt.text " is bold\n"
    else print rt.text " is neither\n"
```

```
}
```

This example prints:

```
  Bold is bold
  Italic is italic
  DXL is neither
```

---

## RichTextParagraph type properties

---

Properties are defined for use with the `.` (dot) operator and a `RichTextParagraph` type handle to extract information from a `RichTextParagraph` type, as shown in the following syntax:

### Syntax

```
for <RichTextParagraph> in <string> do
```

### Operation

Loops through the rich text paragraph `RichTextParagraph` in the string `string`.

The following tables list the properties and the information they extract:

Integer property	Extracts
<code>indentLevel</code>	The indent level of the paragraph. The units are twips (= 1/20 point or 1/1440 inch). Currently the base unit of indentation in Rational DOORS is 360 twips, so values of <code>indentLevel</code> will be multiples of 360.
<code>bulletStyle</code>	The bullet style, as an integer. Currently the only values are 0 (no bullets) and 1 (bullets).

Boolean property	Extracts
<code>isBullet</code>	Whether the paragraph has a bullet point.

String property	Extracts
<code>text</code>	The plain text of the paragraph.

### Example

```
void dumpParagraphs(string s)
{
  RichTextParagraph rp

  for rp in s do {
```

```

        print "****New paragraph\n"
        print "text:" rp.text ":\n "
        print "indent:" rp.indentLevel ": "
        print "bullet:" rp.isBullet ": "
        print "bulletStyle:" rp.bulletStyle ":\n"
    }
}

Object o = current
string s = richText o."Object text"
dumpParagraphs s

```

---

## RichText type properties

---

Properties are defined for use with the . (dot) operator and a RichText type handle to extract information from a RichText type, as shown in the following syntax:

### Syntax

```
for <RichText> in <RichTextParagraph> do
```

### Operation

Loops through the rich text chunks *RichText* in the RichTextParagraph *RichTextParagraph*.

The following tables list the properties and the information they extract:

Integer property	Extracts
<code>indentLevel</code>	The indent level of the rich text chunk. The units are twips (= 1/20 point or 1/1440 inch). Currently the base unit of indentation in Rational DOORS is 360 twips, so values of <code>indentLevel</code> will be multiples of 360. The value will remain the same for all chunks in a line.
<code>bulletStyle</code>	The bullet style, as an integer. Currently the only values are 0 (no bullets) and 1 (bullets). The value will remain the same for all chunks in a line.

Boolean property	Extracts
<code>isBullet</code>	Whether the paragraph has a bullet point. The value will remain the same for all chunks in a line.
<code>isUrl</code>	Whether the rich text chunk is a URL.
<code>isOle</code>	Whether the rich text chunk represents an OLE object.



---

<b>EmbeddedOleObject property</b>	<b>Extracts</b>
-----------------------------------	-----------------

---

getEmbeddedOle	The embedded OLE object represented by the chunk.
----------------	---

---

## Example

```
void dumpAllInfo(RichText rt)
{
    print "*****New chunk:\n"
    print "text:" rt.text ": "
    print "bold:" rt.bold ": "
    print "italic:" rt.italic ": "
    print "underline:" rt.underline ":\n"
    print "strikethru:" rt.strikethru ": "
    print "superscript:" rt.superscript ": "
    print "subscript:" rt.subscript ": "
    print "charset:" rt.charset ":\n"
    print "newline:" rt.newline ": "
    print "last:" rt.last ":\n"
// new in 6.0
    print "isOle:" rt.isOle ": "
    print "indent:" rt.indentLevel ": "
    print "bullet:" rt.isBullet ": "
    print "bulletStyle:" rt.bulletStyle ": "
    print "isUrl:" rt.isUrl ":\n"
}

void dumpAllParagraphs(string s)
{
    RichTextParagraph rp
    RichText rt

    for rp in s do {
        print "****New paragraph\n"
        print "text:" rp.text ":\n "
        print "indent:" rp.indentLevel ": "
        print "bullet:" rp.isBullet ":\n"
        print "bulletStyle:" rp.bulletStyle ":\n"
        for rt in rp do
        {
            dumpAllInfo rt
        }
    }
}
```

```
Object o = current
string s = richTextWithOle o."Object text"

dumpAllParagraphs s
```

---

## Rich text strings

This section defines an operator and functions for strings containing rich text.

---

### Assignment (rich text)

---

The equals operator (=) is used to assign rich text format to attributes, as follows:

#### Syntax

```
attrRef = richText(string s)
```

where *attrRef* can be one of:

```
(Object o). (string attrName)
```

```
(Module m). (string attrName)
```

```
(Link l). (string attrName)
```

where:

<i>o</i>	is an object of type Object
<i>m</i>	is a module of type Module
<i>l</i>	is a link of type Link
<i>attrName</i>	is a string identifying the attribute

#### Operation

Sets the attribute called *attrName* to the rich text string contained in *s*.

#### Example

```
Object o = current
o."Object Text" = richText "{\\b BOLD}"
o."Object Heading" = "{\\b BOLD}"
```

This sets:

- The current object's text to **BOLD**
- The current object's heading to `{\\b BOLD\\}` which is displayed as **{b bold}**

This demonstrates the importance of using the `richText` function in both getting and setting attribute values if you wish to maintain the rich text content. If you do not process the string value with `richText`, all the markup is escaped with backslashes and becomes apparent to the user.

---

## cutRichText

---

### Declaration

```
string cutRichText(string s,
                  int start,
                  int end,)
```

### Operation

Returns the string `s` with the displayed characters from `start` to `end` removed. For the purposes of counting characters, rich text markup is ignored, and markup is preserved.

### Example

```
cutRichText("{\\b 0123456}", 1, 3)
```

This example returns: `{\\b 0456}`

---

## findRichText

---

### Declaration

```
bool findRichText(string s,
                 string sub,
                 int& offset,
                 int& length,
                 bool matchCase)
```

### Operation

Returns `true` if string `s` contains the substring `sub`.

If `matchCase` is `true`, string `s` must contain string `sub` exactly with matching case; otherwise, any case matches.

The function returns additional information in `offset` and `length`. The value of `offset` is the number of characters in `s` to the start of the first match with string `sub`. The value of `length` contains the number of characters in the matching string. The function `replaceRichText` uses `offset` and `length` to replace the matched string with another string.

### Example

```
string s = "{\\b This is Bo{\\i ld and italic}}"
string sub = "bold"
int offset
int len
```

```

if (findRichText(s, sub, offset, len, false)) {
    print "Offset = " offset "\n"
    print "Length = " len "\n"
} else {
    print "Failed to match"
}

```

This example prints:

```
Offset = 12
```

```
Length = 8
```

because the braces are delimiters, not characters in the string.

## isRichText

### Declaration

```
bool isRichText(string s)
```

### Operation

Returns `true` if string `s` is in the Rational DOORS rich text format; otherwise, returns `false`.

If `false` is returned, `s` cannot be used to set any object attribute value.

### Example

This example prints `true` in the DXL Interaction window's output pane:

```
print isRichText "{\\i correct balance}"
```

This example prints `false` in the DXL Interaction window's output pane:

```
isRichText "{\\b missing bracket}"
```

## replaceRichText

### Declaration

```
string replaceRichText(string s,
                       int offset,
                       int length,
                       string r)
```

### Operation

Returns a string, which is equivalent to `s` but with the characters between `offset` and `offset+length` replaced with `r`, whilst retaining formatting tags.

### Example

```
RichText rt
```

```
string s = "{\\b This is Bo{\\i ld and italic}"
```

```
string r = "bOLD"
string result = replaceRichText(s, 12, 8, r)
print result "\n"
Prints:
{\b This is bO{\i LD and italic}}
```

---

## richtext\_identifer(Object)

---

### Declaration

```
string richtext_identifer(Object o)
```

### Operation

Returns the object identifier (which is a combination of module prefix and object absno) as an RTF string.

### Example

```
Object o = current
print richtext_identifer(o)
```

---

## pasteToEditbox

---

### Declaration

```
bool pasteToEditbox()
```

### Operation

Pastes the contents of the clipboard into a module object that is ready for in-place editing. If the paste fails, the function returns false.

### Example

This example pastes bold text to an open module:

```
setRichClip richText "{\\b bold text}"
pasteToEditbox
```

---

## richClip

---

This function has the following syntax:

```
richClip()
```

Gets the rich text contents of the system clipboard as a rich text string.

### Example

```
o."Object Text" = richClip
```

---

## setRichClip

---

### Declaration

```
void setRichClip(richText (string s)
                [,string styleName])
```

### Operation

Sets the system clipboard to contain the rich text string *s*. Optionally, you can include a minimal RTF style sheet that contains a supplied style name, which sets the string style.

### Example

```
setRichClip richText o."Object Text"
// with style sheet
setRichClip(richText o."Object Heading,
            "Heading 1")
```

---

## setRichClip(Buffer/RTF\_string\_\_)

---

### Declaration

```
void setRichClip(RTF_string__ s, string styleName, string fontTable)
void setRichClip(Buffer buff, string styleName, string fontTable)
void setRichClip(RTF_string__ s, string styleName, string fontTable, bool
keepBullets, bool keepIndents)
void setRichClip(Buffer buff, string styleName, string fontTable, bool
keepBullets, bool keepIndents)
```

### Operation

First form sets the system clipboard with the rich text obtained by applying the style *styleName* to the string *s*, using the font table *fontTable* supplied, which should include a default font. Font numbers in the string *s* will be translated to the supplied font table *fontTable*.

Second form is same as the first but the source is a buffer *buff* rather than an RTF\_string\_\_.

Third form sets the system clipboard with the rich text obtained by applying the style *styleName* to the string *s*, using the font table *fontTable* supplied. If *keepBullets* is false, any bullet characters are removed from string *s*. If *keepIndents* is false, any indentation is removed from string *s*. If *keepBullets* and *keepIndents* are both true, the behavior is exactly the same as the first form.

Fourth form is same as the third but the source is a buffer *buff* other than an RTF\_string\_\_.

### Example 1

The following code:

```
string s = "hello"
```

```
string fontTable = "\\deff0{\\fonttbl {\\f1 Times New Roman;}}"
setRichClip(richText s, "Normal", fontTable)
```

puts the following rich text string onto the system clipboard:

```
{\rtf1 \deff0{\\fonttbl {\\f1 Times New Roman;}}{\stylesheet {\\s1 Normal;}}{\\s1
hello\par}}
```

## Example 2

```
string bulletedString =
"{{\rtf1\ansi\ansicpg1252\deff0\deflang1033{\\fonttbl{\\f0\\fswiss\\fcharset
t0 Arial;}{\\f1\\fnil\\fcharset2 Symbol;}}
\\viewkind4\\uc1\\pard\\f0\\fs20 Some text with\par
\\pard{\\pntext\\f1\\'B7\\tab}{\\*\\pn\\pnlvlblt\\pnf1\\pnindent0{\\pntxtb\\'B7
}}\\fi-720\\li720 bullet 1\par
{\\pntext\\f1\\'B7\\tab}bullet 2\par
\\pard bullet points in it.\par
\\par
}"
```

```
string fontTable = "\\deff0{\\fonttbl{\\f0\\fswiss\\fcharset0
Arial;}{\\f1\\fnil\\fcharset2 Symbol;}}"
```

```
setRichClip(richText bulletedString, "Normal", fontTable)
```

```
// the previous call puts
```

```
// "{\rtf1 \deff0{\\fonttbl{\\f0\\fswiss\\fcharset0 Arial;}{\\f1\\fnil\\fcharset2
Symbol;}}{\stylesheet {\\s1 Normal;}}{\\s1 Some text with\par {\\f1\\'b7\\tab}bullet
1\par {\\f1\\'b7\\tab}bullet 2\par bullet points in it.\par \par}"
```

```
// on the clipboard
```

```
setRichClip(richText bulletedString, "Normal", fontTable, false, false)
```

```
// the previous call puts
```

```
// "{\rtf1 \deff0{\\fonttbl{\\f0\\fswiss\\fcharset0 Arial;}{\\f1\\fnil\\fcharset2
Symbol;}}{\stylesheet {\\s1 Normal;}}{\\s1 Some text with\par bullet 1\par bullet
2\par bullet points in it.\par \par}"
```

```
// on the clipboard -- note no bullet symbols (\\'b7) in the markup
```

---

## rtfSubString

---

### Declaration

```
Buffer rtfSubString(Buffer input, Buffer output, int start, int end)
```

### Operation

This function takes an RTF buffer and returns the RTF sub-string between the defined start and end points.

Variable	Description
<i>input</i>	The complete RTF text. This can be full RTF or an RTF fragment, but must be valid RTF and not plain text.
<i>output</i>	The buffer in which the sub-string will be returned. This buffer must be created before calling <code>rtfSubString</code> . This return value will always be full RTF. A reference to this buffer is the return value of the function.
<i>start</i>	The zero-based start point of the sub-string.
<i>end</i>	The end point of the sub-string.

### Example

```
Object o = current
Buffer input = create
Buffer output = create
input = o."Object Text"
rtfSubString(input, output, 4, 8)
print stringOf(output)
```

---

## richText(of attribute)

---

### Declaration

```
Buffer richText(attrRef
                [,bool includeFontTable])
```

where *attrRef* can be one of:

```
(Object o).(string attrName)
(Module m).(string attrName)
(Link l).(string attrName)
```



where:

- `o` is an object of type `Object`
- `m` is a module of type `Module`
- `l` is a link of type `Link`
- `attrName` is a string identifying the attribute

## Operation

Returns the rich text version of an attribute called `attrName`, if `includeFontTable` is `false`, or not present.

If the boolean argument is `true`, it returns the rich text version of an attribute value appended to the font table for that module. The Boolean argument is only applicable to the string version.

This preserves the meaning of font markup when moving rich text attribute values between modules.

## Example

```
print richText (current Object) . "Object Text"
```

If the Object text attribute of the current object is **Engine**:

```
{\b Engine }
Module oldm, newm
Object oldo, newo
oldo = first oldm
newo = create newm
newo."Object Text" = richText(oldo."Object Text", true)
```

## Example 2

```
Object o = current Object
Buffer b = create
b = richText(o."Object Text")
print stringOf b
delete b
```

---

## richText(of string)

---

### Declaration

```
string richText(string s)
```

### Operation

Returns a string, which is the correct rich text version of string `s`. It inserts a backslash escape character before unescaped braces and unescaped backslashes. This makes it suitable for assignment to attribute values.

## Example

```
print richText "{ \\hello }"
```

Prints:

```
"\{ \\hello \}"
```

---

## string exportAttributeToFile

---

### Declaration

```
string exportAttributeToFile(attrRef, string fileNameWithCompletePath)
```

where *attrRef* can be one of:

```
(Object o).(string attrName)
```

```
(Module m).(string attrName)
```

```
(Link l).(string attrName)
```

### Operation

Writes the rich text of attribute *attr*, including the OLE objects to file *fileNameWithCompletePath*. If *fileNameWithCompletePath* does not already exist, it is created. If it already exists, it is overwritten.

Returns null on success, or an error message on failure.

---

## stringOf(rich text)

---

### Declaration

```
string stringOf(richText(string s))
```

### Operation

This enables access to rich text as a string.

---

## richTextWithOle

---

### Declaration

```
string richTextWithOle(attrRef attr)
```

where *attrRef* is in one of the following formats:

```
(Object o).(string attrName)
```

```
(Module m).(string attrName)
```

```
(Link l).(string attrName)
```

## Operation

Returns the rich text of attribute *attr*, including the OLE objects. The use of this perm should be confined to copying rich text values from one attribute to another.

### richTextWithOleNoCache

#### Declaration

```
string richTextWithOleNoCache(attrRef attr)
```

where *attrRef* is in one of the following formats:

```
(Object o).(string attrName)
```

```
(Module m).(string attrName)
```

```
(Link l).(string attrName)
```

#### Operation

Returns the rich text of attribute *attr*, including the OLE objects, and clears the OLE cache. The use of this perm should be confined to copying rich text values from one attribute to another.

### richTextNoOle

#### Declaration

```
string richTextNoOle(attrRef attr)
```

where *attrRef* is in one of the following formats:

```
(Object o).(string attrName)
```

```
(Module m).(string attrName)
```

```
(Link l).(string attrName)
```

#### Operation

Returns the rich text of attribute *attr*, excluding the OLE objects. The use of this perm should be confined to copying rich text values from one attribute to another.

### applyTextFormattingToParagraph

#### Declaration

```
string applyTextFormattingToParagraph(string s, bool addBullets,  
int indentLevel, int paraNumber, [int firstIndent])
```

#### Operation

Applies bullet and/or indent style to the given text, overwriting any existing bulleting/indenting.

- If *addBullets* is true, adds bullet style.

- If *indentLevel* is nonzero, adds indenting to the value of *indentLevel*. The units for *indentLevel* are twips = twentieths of a point.
- If *paraNumber* is zero, the formatting is applied to all the text. Otherwise it is only applied to the specified paragraph number.
- If the optional parameter *firstIndent* is specified, then this sets the first line indent. If the value is negative then this sets a hanging indent. The units are in points.

The input string *s* must be rich text. For example, from `string s = richText o."Object Text"`.

Returns a rich text string which describes the text with the formatting applied.

### Example

```
Object o = current
string s = o."Object text"
o."Object text" = richText (applyTextFormattingToParagraph(richText
s,true,0,0))
```

Adds bullet style to all of the current object's text.

## exportRTFString

### Declaration

```
string exportRTFString(string text)
```

### Operation

Translates a Rational DOORS rich text string to the RTF standard. Newlines are converted into `\par` tags, not `\newline`.

For use with legacy RTF only, any new code should use `removeUnlistedRichText`.

### Example

```
Object o = current
string str = o."Object Text"
string rtf_string = exportRTFString(str)
```

## richTextFragment

### Declaration

```
string richTextFragment(string richString)
string richTextFragment(string richString, string fontTable)
string richTextFragment(string richText [, string fontTable [, bool
inTable]])
```

## Operation

The first form takes an argument *richFrag* which should be a rich text string. Returns an equivalent representation of the rich text with RTF header information removed. Useful for building up a real RTF string without having to cope with the header information every time. Font markup will be mapped to the Rational DOORS default font table.

The second form is the same as the first except for the second argument, *fontTable*, which is a font table string. Any font markup in the string is mapped to the first font in the font table passed in which has the same character set as the original markup.

The third form has an optional boolean argument which, if provided and set to `true`, ensures that the returned rich text string is valid as contents of a rich text table. Use this setting if multiple paragraphs are exported to a single table cell and the resulting rich text output is to be opened by MS-Word 2000.

### Example 1

```
string richString =
"{\\rtf1\\ansi\\ansicpg1252\\deff0\\deflang1033
{\\fonttbl{\\f0\\fnl\\fprq1\\fcharset0 Times New Roman;}
{\\f1\\froman\\fprq2\\fcharset2 Symbol;}}
{\\colortbl ;\\red0\\green0\\blue0;}
\\viewkind4\\uc1\\pard\\cf1\\f0\\fs20
Some plain text.
\\b Some bold text.\\b0
  \\b\\i Some bold and italic text. \\b0\\i0
A symbol \\f1 a\\f0 (alpha).\\b\\i\\par }"

print richTextFragment richString

// returns

// Some plain text. \\b Some bold text.\\b0  \\b \\i Some bold and italic text.
\\b0 \\i0 A symbol \\{\\f1001 a}\\{\\f1007 (alpha).\\}
```

### Example 2

```
string fontTable =
"\\deff1{\\fonttbl
{\\f0\\fswiss\\fcharset0 Arial;}
{\\f1\\froman\\fprq2\\fcharset0 Times New Roman;}
{\\f2\\froman\\fprq2\\fcharset2 Symbol;}}"
```

```
print richTextFragment( richString, fontTable)

// returns

// Some plain text. \b Some bold text.\b0  \b \i Some bold and italic text.
\b0 \i0 A symbol {\f2 a}{\f0 (alpha).}
```

---

## Enhanced character support

This section lists constants and defines functions for the display and printing of characters outside the ANSI character set.

---

### Character set constants

For the display and printing of characters outside the ANSI character set, you can specify another character set. For the results to be correct, you must have the appropriate fonts installed. The following integer character set constants are declared:

```
charsetAnsi
charsetSymbol
charsetGreek
charsetRussian
charsetEastEurope
charsetTurkish
charsetHebrew
```

Certain UNIX machines may not display some characters correctly.

For an example of the use of character set constants, see "Character set identification" below.

---

### Character set identification

The dot operator (.) is used to identify the character set of rich text, as follows:

#### Syntax

```
richString.charset()
```

where:

*richString* is a chunk of rich text of type `RichText`

#### Operation

Returns the character set of a chunk of rich text.

## Example

```
for rt in s do {
    if (rt.charset == charsetAnsi) {
        print rt.text " is in the ANSI character
                      set\n"
    } else if (rt.charset == charsetSymbol) {
        print rt.text " is in the Symbol character
                      set\n"
    } else {
        print rt.text " is in character set number
                      " rt.charset "\n"
    }
}
```

---

## charsetDefault

---

### Declaration

```
int charsetDefault()
```

### Operation

Returns the system default character set. On UNIX platforms, this is always `charsetAnsi`. On Windows systems, this is the user's local setting.

### Example

```
string s
RichText rt
for rt in s do {
    if (rt.charset == charsetAnsi) {
        print rt.text " is in the ANSI character
                      set\n"
    } else if (rt.charset == charsetSymbol) {
        print rt.text " is in the Symbol character
                      set\n"
    } else {
        print rt.text " is in the character set
                      number " rt.charset "\n"
    }
}
if (rt.charset == charsetDefault) {
    print rt.text " is in your system default
                  character set\n"
}
}
```

---

## characterSet

---

### Declaration

```
void characterSet(DBE canvas,  
                int level,  
                int mode,  
                int characterSet)
```

### Operation

Sets the level, mode and character set for drawing strings on the canvas. Through the font tables, this sets the font.

### Example

```
DB symbolBox = create "Symbols"  
void repaint(DBE symbol) {  
    int fsize = 1 // level 1 size  
    int mode = 0 // body text style  
    background(symbol,  
               logicalPageBackgroundColor)  
    color(symbol, logicalDataTextColor)  
    characterSet(symbol, fsize, mode,  
                 charsetAnsi)  
    draw(symbol, 10, 20, "abc")  
    // appears as abc  
    characterSet(symbol, fsize, mode,  
                 charsetSymbol)  
    draw(symbol, 40, 20, "abc")  
    // appears as alpha beta chi  
}  
DBE symbol = canvas(symbolBox, 100, 50, repaint)  
show symbolBox
```

---

## fontTable

---

### Declaration

```
string fontTable(Module m)
```

### Operation

Returns the module's font table, which is used for mapping rich text font markup to character set information.



## Example

```
print fontTable current Module
```

In a newly created module, the Rational DOORS default font table is:

```
{\f1016\fswiss\fcharset134 Tahoma;}
{\f1015\fswiss\fcharset136 Tahoma;}
{\f1014\fswiss\fcharset129 Tahoma;}
{\f1013\fswiss\fcharset128 Tahoma;}
{\f1012\fswiss\fcharset177 Arial;}
{\f1011\fswiss\fcharset162 Arial;}
{\f1010\fswiss\fcharset238 Arial;}
{\f1009\fswiss\fcharset204 Arial;}
{\f1008\fswiss\fcharset161 Arial;}
{\f1007\fswiss\fcharset0 Arial;}
{\f1006\froman\fcharset177 Times New Roman;}
{\f1005\froman\fcharset162 Times New Roman;}
{\f1004\froman\fcharset238 Times New Roman;}
{\f1003\froman\fcharset204 Times New Roman;}
{\f1002\froman\fcharset161 Times New Roman;}
{\f1001\fttech\fcharset2 Symbol;}
{\f1000\froman\fcharset0 Times New Roman;}
```

---

## Importing rich text

This section defines a function for importing rich text.

---

### importRTF

---

#### Declaration

```
int importRTF(string file,
              Module m,
              bool mapStyles,
              bool dynamicUpdate)
```

## Operation

Imports the rich text format file `file`, into a new sibling at the same level as the current object of module `m`. If `mapStyles` is set, you are prompted to match styles if non-standard styles are used. If `dynamicUpdate` is set, the displayed module is refreshed.

## Returns

```
#define ecOK          0    /* Everything's fine! */
#define ecStackUnderflow 1  /* Unmatched '}' */
#define ecStackOverflow 2  /* Too many '{' -- memory exhausted */
#define ecUnmatchedBrace 3 /* RTF ended during an open group. */
#define ecInvalidHex  4  /* invalid hex character found in data */
#define ecBadTable    5  /* RTF table (sym or prop) invalid */
#define ecAssertion   6  /* Assertion failure */
#define ecEndOfFile   7  /* end of file reached */
#define ecFileNotFound 8  /* The file could not be found (or opened) */
```

## Example

```
Int i = importRTF("c:\\doors\\examples\\parse.rtf", current Module, false,
false)
if (i == 0)
{
    print "Successful\n"
} else {
    print "Failed - return code " i " \n"
}
```

---

## Diagnostic perms

These perms are for run-time richText/OLE DXL diagnostics. DXL scripts written for pre-V6 Rational DOORS do not specify whether OLE objects should be included in richText extracted from Object Text attributes or the main column in a view. If diagnostics are enabled, the user can be given warnings when this occurs, enabling the user to replace the `richText()` call with `richTextWithOle()` or `richTextNoOle()`. The user can also be warned when a new value is assigned to an Object Text attribute, as this will now replace any OLE objects in the Object Text.

---

### enableObjectTextAssignmentWarnings

---

#### Declaration

```
enableObjectTextAssignmentWarnings(string logFile)
```

## Operation

Enables warnings whenever a new value is assigned to an Object Text attribute. Warnings are disabled by default. This perm returns no value. The *logFile* argument enables the user to specify a file where filenames and line numbers will be logged, where warnings are issued. If this argument is null, no logging is done. If the file cannot be opened, a warning message is displayed. If a log file has already been opened, this argument has no effect.

## disableObjectTextAssignmentWarnings

### Declaration

```
disableObjectTextAssignmentWarnings()
```

### Operation

Disables warnings whenever a new value is assigned to an Object Text attribute. Warnings are disabled by default. This perm returns no value.

## enableObjectTextRichTextWarnings

### Declaration

```
enableObjectTextRichTextWarnings(string logFile)
```

### Operation

Enables warnings whenever the *richText (Attribute)* perm is applied to an Object Text attribute, or the *richText (Column, Object)* perm is applied to the Main column. The *logFile* argument is treated the same way as that for *enableObjectTextAssignmentWarnings ()*. If a *logFile* has already been opened, this argument has no effect.

This perm returns no value.

## disableObjectTextRichTextWarnings

### Declaration

```
disableObjectTextRichTextWarnings()
```

### Operation

Disables warnings when the *richText (Attribute)* perm is applied to an Object Text attribute, or the *richText (Column, Object)* perm is applied to the Main column. If *enableGeneralRichTextWarnings ()* has been called, warnings will still be issued for all *richText ()* perms, until *disableGeneralRichTextWarnings ()* is called.

This perm returns no value.

---

## enableGeneralRichTextWarnings

---

### Declaration

```
enableGeneralRichTextWarnings(string logFile)
```

### Operation

Enables warnings whenever the `richText (Attribute)` or `richText (Column, Object)` perm is called. The `logFile` argument is treated the same way as for the other `enable` perms above. This perm returns no value.

---

## disableGeneralRichTextWarnings

---

### Declaration

```
disableGeneralRichTextWarnings()
```

### Operation

Normally disables warnings whenever the `richText (Attribute)` or `richText (Column, Object)` perm is called. The exception to this is if `enableObjectTextRichTextWarnings()` has been called, warnings will still be issued when these `richText` perms are applied to Object Text or the Main column. This perm returns no value.

---

## enableRepeatWarnings

---

### Declaration

```
enableRepeatWarnings()
```

### Operation

Enables multiple repeated warnings to be issued for the same DXL script file/line-number combination, whenever that code is executed by the interpreter. By default, only one warning is issued for any file/line in any one Rational DOORS client session. This perm returns no value.

---

## disableRepeatWarnings

---

### Declaration

```
disableRepeatWarnings()
```

### Operation

This perm negates the effect of `enableRepeatWarnings()`. It returns no value. Note that the repeat prevention does not apply to DXL scripts run from the DXL Interaction window.

---

## disableDisplayWarnings

---

### Declaration

```
disableDisplayWarnings ()
```

### Operation

Disables the pop-up warning dialogs. If enabled, warnings are still logged in the specified `logFile`. This perm returns no value.

---

## enableDisplayWarnings

---

### Declaration

```
enableDisplayWarnings ()
```

### Operation

Enables pop-up warning dialogs. It returns no value.

---

## dxlWarningFilename

---

### Declaration

```
string dxlWarningFilename ()
```

### Operation

Returns the filename quoted in the last pop-up warning dialog.

---

## dxlWarningLineNumber

---

### Declaration

```
int dxlWarningLineNumber ()
```

### Operation

Returns the line number quoted in the last pop-up warning dialog.



## Chapter 33

# Spelling Checker

This chapter describes the following features of the spelling checker:

- Constants and general functions
- Language and Grammar
- Spelling Dictionary
- Miscellaneous Spelling
- Spelling\Dictionary Examples

---

## Constants and general functions

---

### Language Constants

---

#### Operation

The following are used to specify one of the standard supported languages:

`USEnglish`

`UKEnglish`

`French`

`German`

`GermanReform`

#### Example

```
SpellingOptions options
getOptions(options, userSpellingOptions)
setLanguage(options, German)
saveOptions(options)
```

---

### Options Constants

---

#### Operation

The following are used by the `getOptions` function to specify which set of spelling options are to be opened:

`databaseSpellingOptions`

```
userSpellingOptions
```

### Example

```
SpellingOptions options
getOptions(options, databaseSpellingOptions)
```

## Dictionary Constants

### Operation

The following are used by the open function to indicate which type of dictionary is to be opened:

```
databaseDictionary
clientDictionary
```

### Example

```
Dictionary d
open(d, clientDictionary)
insert(d, "IBM")
```

## Grammar Constants

### Operation

The following are used to define the formality of grammar checking:

```
informalGrammar
standardGrammar
formalGrammar
```

### Example

```
SpellingOptions options
getOptions(options, userSpellingOptions)
setGrammarLevel(options, informalGrammar)
saveOptions(options)
```

## Spell Check Mode Constants

### Operation

The following are used to define the level of spell checking to be carried out:

```
spellingOnly
```



```
quickProof
fullProof
```

## Example

```
SpellingOptions options
getOptions(options, userSpellingOptions)
setCheckMode(options, quickProof)
```

## spell

### Declaration

```
string spell(string word)
string spell(Object o,
             string attrName,
             int &start,
             int &end)
```

### Operation

The first form checks the word for spelling, and returns a null string if it is correct or if *word* is a null string. If the spelling is not correct, returns an error message.

The second form checks the attribute name for spelling, and returns a null string if it is correct, if *attrName* is a null string, or if the specified attribute is not contained in the specified object. If the spelling is not correct, returns an error message. It only works with string or text attributes.

The *start* and *finish* arguments must be initialized to *zero* before the function is called. If the contents of *attrName* are misspelled, the function sets the values of *start* and *finish* to identify the first and last characters of the incorrectly spelled substring.

### Example

```
Object o = current
// check status
if (o != null)
{
    int iStart = 0, iFinish = 0
    // get attribute info
    string sObjectHeading = probeRichAttr_(o,
                                           "Object Heading")

    int iLength = length(sObjectHeading)
    // process attribute
    while (iStart < iLength)
    {
        // check attribute
```

```

    if (spell(o, "Object Heading", iStart,
              iFinish) != null)
    {
        // warn user
        print "Spelling mistake located ["
              iStart ":" iFinish "] - '"
              sObjectHeading[iStart:iFinish] "'\n"
        // adjust accordingly
        iStart = iFinish
    }
}

```

---

## spellFix

---

### Declaration

```

string spellFix(Object o,
                string attrName,
                int &start,
                int &end,
                string newString)

```

### Operation

Replaces a misspelled string within the specified attribute, which must be a string or text attribute. The string is identified using *start* and *finish*, provided the `spell` function has previously been called on the object and attribute.

In cases where the new string is a different length from the misspelled substring, the function resets the values of *start* and *finish*.

Returns a null string if it the substring is replaced successfully or if the specified attribute is not contained in the specified object. Otherwise, returns an error message.

---

## alternative

---

### Declaration

```

string alternative(int n)

```

### Operation

Returns the *n*th spelling for the word last passed to `spell`.

---

## alternatives

---

### Declaration

```

int alternatives()

```

## Operation

Returns the number of options found for the last call to `spell`.

---

### for all spellings

---

#### Syntax

```
for s in alternatives do {
    ...
}
```

where:

`s` is a string variable

#### Operation

Assigns string `s` to be each successive value found for the last spelling check.

#### Example

```
string mess = spell("whta")
if (null mess) {
    print "You are a spelling bee\n"
} else {
    int n = alternatives
    print "There are " n " other spellings:\n"
        string altSpelling

    for altSpelling in alternatives do
        print altSpelling "\n"
}
```

---

### spell

---

#### Declaration

```
Buffer spell(Buffer returnBuffer, Buffer word)
```

```
Buffer spell(Buffer returnBuffer,
    Object o,
    string attribute,
    int &wordStart,
    int &wordEnd,
    int &sentenceStart,
    int &sentenceEnd,
    int &ruleType,
    bool spellingErrorsFirst,
    bool &deletionError)
```

## Operation

First form of the spell perm that returns a buffer *returnBuffer*, to reduce memory usage caused by using strings. The perm returns an empty Buffer if the *word* is correct, or an error message otherwise.

- *returnBuffer*

Buffer used to create the return value - must be created before calling.

- *word*

The word to be checked.

The second form of this perm checks spelling and grammar in the named attribute *attribute* of the specified object *o*. If an error is found, the error details returned in the parameters relate to the first error. Call `getNextError()` to view subsequent error details.

Variable	Description
<i>returnBuffer</i>	Buffer used to create the return value - must be created before calling.
<i>o</i>	The object to be checked.
<i>attribute</i>	Name of the specific attribute to be checked.
<i>wordStart</i>	If an error is found, returns the start position of the incorrect word in the attribute text.
<i>wordEnd</i>	If an error is found, returns the end position of the incorrect word.
<i>sentenceStart</i>	If an error is found, returns the start position of the sentence containing the error.
<i>sentenceEnd</i>	If an error is found, returns the end position of the sentence containing the error.
<i>ruleType</i>	If an error is found, returns the code of the rule that triggered the error.
<i>spellingErrorsFirst</i>	Specifies whether spelling errors should be reported before grammar errors - note that this operates at a sentence level.
<i>deletionError</i>	If an error is found, this flag indicates that the error type recommends that text is deleted (e.g. this will occur when a word is duplicated, such as "This is is an error.")

---

## getNextError

---

### Declaration

```
void getNextError(Buffer errorString,
                  int &wordStart,
                  int &wordEnd,
                  int &sentenceStart,
                  int &sentenceEnd,
```

```

bool &correctionComplete,
bool skipSentence,
int &ruleType,
bool &deletionError)

```

## Operation

Returns errors found after a call to `spell(Buffer, Object, string, int, int, int, int, int, bool, bool)`. Note that this perm does not return errors found after calling any other variant of the `spell` perm.

Variable	Description
<code>returnBuffer</code>	If an error is found, the description will be placed in this buffer - must be created before calling.
<code>wordStart</code>	If an error is found, returns the start position of the incorrect word in the attribute text.
<code>wordEnd</code>	If an error is found, returns the end position of the incorrect word.
<code>sentenceStart</code>	If an error is found, returns the start position of the sentence containing the error.
<code>sentenceEnd</code>	If an error is found, returns the end position of the sentence containing the error.
<code>correctionComplete</code>	This flag will be returned <code>true</code> if no more errors were found.
<code>skipSentence</code>	Set this flag when calling to ignore any remaining errors in the current sentence.
<code>ruleType</code>	If an error is found, returns the code of the rule that triggered the error.
<code>deletionError</code>	If an error is found, this flag indicates that the error type recommends that text is deleted.

---

## SpellingErrors\_\_

---

### Declaration

```
SpellingErrors__ spellingErrors()
```

### Operation

Structure encapsulating information about spelling and grammatical errors.

---

## for SpellingError in SpellingErrors\_\_

---

### Declaration

```
for SpellingError in SpellingErrors__
```

## Operation

Loop to iterate over errors found after calling the `spell(Buffer, Object, string, int&, int&, int&, int&, int&, bool, bool&)` perm. Note that this loop does not list errors found after calling any other variant of the `spell` perm.

## getErrorString

### Declaration

```
Buffer getErrorString(Buffer returnBuffer, SpellingError spellErr)
```

### Operation

Returns a description for the specified error `spellErr`. The `returnBuffer` parameter must be created before calling.

## getErrorStartPos(SpellingError)

### Declaration

```
int getErrorStartPos(SpellingError spellErr)
```

### Operation

Used inside the `'for error in spellingErrors do'` loop. Returns the position of the start of the spelling/grammatical error relative to the start of the object.

## getErrorStopPos(SpellingError)

### Declaration

```
int getErrorStopPos(SpellingError spellErr)
```

### Operation

Used inside the `'for error in spellingErrors do'` loop. Returns the position of the last character of the spelling/grammatical error relative to the start of the object.

## getSentenceStartPos(SpellingError)

### Declaration

```
int getSentenceStartPos(SpellingError spellErr)
```

### Operation

Used inside the `'for error in spellingErrors do'` loop. Returns the position of the first character in the sentence containing the spelling/grammatical error relative to the start of the object.

---

## getSentenceStopPos(SpellingError)

---

### Declaration

```
int getSentenceStopPos(SpellingError spellErr)
```

### Operation

Used inside the 'for error in spellingErrors do' loop. Used inside the 'for error in spellingErrors do' loop. Returns the position of the last character in the sentence containing the spelling/grammatical error relative to the start of the object.

---

## getCorrectionComplete(SpellingError)

---

### Declaration

```
bool getCorrectionComplete(SpellingError spellErr)
```

### Operation

Used inside the 'for error in spellingErrors do' loop. Returns true if the spell check is complete otherwise false.

---

## ignoreWord

---

### Declaration

```
void ignoreWord(string word)
```

### Operation

Causes the specified *word* to be ignored if it is found to be incorrect during spell checking. The *word* is ignored until `resetSpellingState` is called.

---

## for Buffer in SpellingAlternatives\_\_

---

### Declaration

```
for b in spellAlt do {
    ...
}
```

where:

<i>b</i>	is a variable of type Buffer
<i>spellAlt</i>	is a variable of type SpellingAlternatives__

## Operation

A loop to iterate through alternative words found after a spelling error. Alternative words are returned in a Buffer object, but note that the user should not create or destroy the Buffer.

---

### alternative

---

#### Declaration

```
Buffer alternative(Buffer returnBuffer, int index)
```

#### Operation

Returns the alternative word at the specified index position, after a spelling error. The *returnBuffer* parameter must be created before calling. An error will be reported if the *index* is out of range.

---

## Language and Grammar

---

### Languages\_\_

---

#### Declaration

```
Languages__ languages ()
```

#### Operation

Type to iterate through `spLanguageInfo`

---

### Language

---

#### Declaration

```
Language lang
```

#### Operation

Type to encapsulate details of available language databases.

---

### spGetLanguages

---

#### Declaration

```
int spGetLanguages ()
```



## Operation

Fills the list of available languages. This will be a list of those languages that are supported by the spell checker and whose language database is present on the local client. Returns the number of available languages.

## for Language in Languages\_\_

### Declaration

```
for Language in Languages__
```

### Operation

Iterates through the specified Languages.

## getLanguage

### Declaration

```
Language getLanguage(int index)
```

### Operation

Returns the `spLanguageInfo` structure for the language at the specified `index` in the list of available languages. If the `index` value is outwith the range of available languages, an error report is generated.

## getId

### Declaration

```
int getId(Language lang)
```

### Operation

Returns the ID of the specified language `lang`. (e.g. "English", "German").

## getName

### Declaration

```
string getName(Language lang)
```

### Operation

Returns a string identifying the specified language `lang`. (e.g. "UK English", "German").

---

## isSupported

---

### Declaration

```
bool isSupported(Language lang)
```

### Operation

Returns a boolean indicating if the specified language *lang* is officially supported by Rational DOORS. At present, this covers US English, UK English, French and German (pre- and post-Reform).

---

## getGrammarRules

---

### Declaration

```
int getGrammarRules(SpellOptions &spellOptions, GrammarRules &gramRules)
```

### Operation

Gets a list of active grammar rules for the specified options set *spellOpt*, returning the number of active rules *&gramRules*. Active rules are determined by the current language and grammar strictness level.

The `GrammarRules` parameter must be initialized to 'null' before calling.

---

## getName

---

### Declaration

```
Buffer getName(GrammarRules &gramRules, int index, Buffer buf)
```

### Operation

Returns the short name of the grammar rule at the position specified by the *index* parameter in the set of grammar rules *&gramRules*. If the value of *index* is greater than the number of active rules, an error report is generated. The *buf* parameter is a Buffer that is used to create the return value; it must be created by the user before calling and deleted afterwards.

---

## getExplanation

---

### Declaration

```
string getExplanation(GrammarRules &gramRules, int index, Buffer buf)
```

### Operation

Returns a full explanation of the grammar rule at the position specified by the *index* parameter in the set of grammar rules *&gramRules*. If the value of *index* is greater than the number of active rules, an error report is generated. The *buf* parameter is a Buffer that is used to create the return value; it must be created by the user before calling and deleted afterwards.

---

## getOptions

---

Structure encapsulating spell checker options.

### Declaration

```
string getOptions(SpellingOptions &spellOptions, int optionsSet)
```

### Operation

Gets set of spelling options. The *optionsSet* parameter indicates which set of options to load. At present this is limited to the database-wide default settings (defined by *spDatabaseOptions* with a value of 0) and the user's personal setting (*spUserOptions* with a value of 1). Any other value will return a failure message. Where a user's settings have not yet been configured, the database default values will be returned. An error string is returned if there is a problem reading the options files, but in this case the *SpellingOptions* parameter will contain standard defaults.

---

## save(SpellingOptions)

---

### Declaration

```
string save(SpellingOptions &spellOptions)
```

### Operation

Saves the spelling options.

If the options was loaded as the database defaults, the user must have sufficient access rights to modify database settings, otherwise the function will return an error string.

---

## getLanguage

---

### Declaration

```
int getLanguage(SpellingOptions &spellOptions)
```

### Operation

Returns the ID of the spelling checking language defined in the *SpellingOptions* parameter.

---

## setLanguage

---

### Declaration

```
string setLanguage(SpellingOptions &spellOptions, int languageId)
```

### Operation

Sets the spell checking language in the specified set of *SpellingOptions*. If the *languageId* is invalid, the function will return an error string.

---

## getEnglishOptions

---

### Declaration

```
string getEnglishOptions(SpellingOptions &spellOptions, bool &legalLexicon,  
bool &financialLexicon)
```

### Operation

Returns boolean values indicating the state of options specific to US and UK English. Returns error string if the parameters are missing from the options set.

---

## setEnglishOptions

---

### Declaration

```
string setEnglishOptions(SpellingOptions &spellOptions, bool &legalLexicon,  
bool &financialLexicon)
```

### Operation

Sets a boolean value indicating the state of options specific to US and UK English. These can be modified if a language other than English is selected.

---

## getUKOptions

---

### Declaration

```
string getUKOptions(SpellingOptions &spellOptions, bool &izeEndings)
```

### Operation

Returns a boolean value indicating the state of an option specific to UK English.

---

## setUKOptions

---

### Declaration

```
string setUKOptions(SpellingOptions spellOptions, bool izeEndings)
```

### Operation

Sets a boolean value indicating the state of an option specific to UK English. This option can be set even if a language other than UK English is selected.

---

## getFrenchOptions

---

### Declaration

```
string getFrenchOptions(SpellingOptions &spellOptions, bool &openLigature, bool &accentedUpperCase)
```

### Operation

Gets boolean values indicating the state of options specific to French.

---

## setFrenchOptions

---

### Declaration

```
string setFrenchOptions(SpellingOptions &spellOptions, bool &openLigature, bool &accentedUpperCase)
```

### Operation

Sets boolean values indicating the state of options specific to French. These options can be set even if a language other than French is selected.

---

## getGermanOptions

---

### Declaration

```
string getGermanOptions(SpellingOptions &spellOptions, bool &scharfes)
```

### Operation

Gets boolean values indicating the state of options specific to German.

---

## setGermanOptions

---

### Declaration

```
string setGermanOptions(SpellingOptions &spellOptions, bool &sharfes)
```

### Operation

Sets boolean values indicating the state of options specific to German. These options can be set even if a language other than German is selected.

---

## getGreekOptions

---

### Declaration

```
string getGreekOptions(SpellingOptions, bool& accentedUpperCase)
```

### Operation

Gets boolean values indicating the state of options specific to Greek.

---

## setGreekOptions

---

### Declaration

```
string setGreekOptions(SpellingOptions, bool accentedUpperCase)
```

### Operation

Sets boolean values indicating the state of options specific to Greek. These options can be set even if a language other than Greek is selected.

---

## getSpanishOptions

---

### Declaration

```
string getSpanishOptions(SpellingOptions, bool& accentedUpperCase)
```

### Operation

Gets boolean values indicating the state of options specific to Spanish.

---

## setSpanishOptions

---

### Declaration

```
string setSpanishOptions(SpellingOptions, bool accentedUpperCase)
```

### Operation

Sets boolean values indicating the state of options specific to Spanish. These options can be set even if a language other than Spanish is selected.

---

## getCatalanOptions

---

### Declaration

```
string getCatalanOptions(SpellingOptions, bool& periodMode)
```

## Operation

Gets boolean values indicating the state of options specific to Catalan.

## setCatalanOptions

### Declaration

```
string setCatalanOptions(SpellingOptions, bool periodMode)
```

### Operation

Sets boolean values indicating the state of options specific to Catalan. These options can be set even if a language other than Catalan is selected.

## getRussianOptions

### Declaration

```
string getRussianOptions(SpellingOptions, bool& joMode)
```

### Operation

Gets boolean values indicating the state of options specific to Russian.

## setRussianOptions

### Declaration

```
string setRussianOptions(SpellingOptions, bool joMode)
```

### Operation

Sets boolean values indicating the state of options specific to Russian. These options can be set even if a language other than Russian is selected.

## getGrammarLevel

### Declaration

```
int getGrammarLevel(SpellingOptions &spellOptions)
```

### Operation

Returns an integer value indicating the strictness of grammar checking.

---

## setGrammarLevel

---

### Declaration

```
string setGrammarLevel(SpellingOptions &spellOptions, int grammar)
```

### Operation

Sets an integer value indicating the strictness of grammar checking. Returns an error string if the grammar level is invalid, or if the user does not have sufficient rights to modify settings.

---

## setSpellingCheckingMode

---

### Declaration

```
string setSpellingCheckingMode(int spellMode)
```

### Operation

Sets the mode for spell checking - the parameter is a value indicating spelling only, quick proof, or full proof modes. Returns an error string if the mode value is invalid or the user does not have sufficient rights to modify settings.

---

## getSpellingCheckingMode

---

### Declaration

```
int getSpellingCheckingMode()
```

### Operation

Returns a value indicating the current spell checking mode.

---

## getSpellingFirst

---

### Declaration

```
bool getSpellingFirst(SpellOptions &spellOptions)
```

### Operation

Returns a flag indicating if spelling errors are to be returned before grammar errors in the specified options set.

---

## setSpellingFirst

---

### Declaration

```
string setSpellingFirst(SpellOptions &spellOptions, bool errors)
```



## Operation

Sets a flag indicating if spelling errors are to be returned before grammar errors in the specified options set. Returns an error string if the user does not have sufficient rights to modify settings.

## getIgnoreReadOnly

### Declaration

```
bool getIgnoreReadOnly(SpellOptions &spellOptions)
```

### Operation

Returns a flag indicating if objects that are read only are to be ignored (not checked) in the specified options set.

## setIgnoreReadOnly

### Declaration

```
string setIgnoreReadOnly(SpellOptions &spellOptions, bool read)
```

### Operation

Sets a flag indicating if objects that are read only are to be ignored (not checked) in the specified options set. Returns an error string if the user does not have sufficient rights to modify settings.

# Spelling Dictionary

## Dictionary

A new type to represent a dictionary, including its type (database or client) and contents. A variable of this type should be initialized to null before opening the dictionary.

## open(Dictionary)

### Declaration

```
string open(Dictionary &dict, int dictionaryType)
```

```
string open(Dictionary &dict, int languageId, int dictionaryType)
```

### Operation

The first form opens a client or database dictionary for the language defined in the current user's spelling options. The Dictionary parameter should be initialized to null before calling this function. Returns a string indicating failure, or null if successful. A dictionary must be opened to make its contents available to the spell checker.

Note that there is an upper limit on the number of dictionaries that can be opened at any one time, so it is important that the dictionary is explicitly closed using `spCloseDictionary` after use.

This function will load the dictionary ACL if the dictionary type is set to `spDatabaseDictionary`.

The second form opens a client or database dictionary for the language specified. This opens a temporary dictionary for management functions (such as adding and removing words), and the contents of this dictionary will not be used in normal spell checking. The `Dictionary` parameter should be initialized to null before calling this function. Returns a string indicating failure, or null if successful.

It is important that the dictionary is explicitly closed using `spCloseDictionary` after use.

This function will load the dictionary ACL if the dictionary type is set to `spDatabaseDictionary`.

## close(Dictionary)

### Declaration

```
string close(Dictionary &dict, bool saveContents)
string close(Dictionary &dict, bool saveContents, bool saveACL)
```

### Operation

The first form closes the specified dictionary. If the `saveContents` parameter is `true`, and the user has sufficient permissions, the contents of the dictionary will be saved. This function will not save any changes to the dictionary access control list. Note that this function resets the dictionary parameter to 'null'.

The second form closes the specified dictionary. If the `saveContents` parameter is `true`, and the user has sufficient permissions, the contents of the dictionary will be saved. If the `saveACL` parameter is `true`, and the dictionary type was Database dictionary, and the user has sufficient permissions, the dictionary access control list will be saved. Note that this function resets the dictionary parameter to 'null'.

## alternativeWord

### Declaration

```
alternativeWord
```

### Operation

Structure to encapsulate a word and its suggested alternative.

## for Buffer in Dictionary

### Declaration

```
for b in &dict do {
    ...
}
```

where:

*b* is a variable of type `Buffer`  
*&dict* is a variable of type `Dictionary`

## Operation

Iterator over the words in a dictionary. The user does not need to create the `Buffer` before the loop; the user should not delete the `Buffer` inside or after the loop.

## for alternativeWord in Dictionary

### Declaration

```
for altWord in &dict do {
    ...
}
```

where:

*altWord* is a variable of type `alternativeWord`  
*&dict* is a variable of type `Dictionary`

### Operation

Iterator over the alternative words in a dictionary.

## getWord

### Declaration

```
Buffer getWord(alternativeWord altWord, Buffer b)
```

### Operation

Returns the word component of an `spAltWord` structure. The *b* parameter is used to create the return value and should be created before calling and deleted afterwards.

## getAlternative

### Declaration

```
Buffer getAlternative(alternativeWord altWord, Buffer b)
```

## Operation

Returns the alternative word component of an `spAltWord` structure. The `b` parameter is used to create the return value and should be created before calling and deleted afterwards.

## insert

### Declaration

```
string insert(Dictionary &dict, string word, string alternative)
```

### Operation

Adds a word and a preferred alternative word to the specified dictionary.

Returns an error string if the user does not have sufficient rights to modify the dictionary.

## remove

### Declaration

```
string remove(Dictionary &dict, string word)
```

### Operation

Removes a `word` from the specified dictionary.

Returns an error string if the user does not have sufficient rights to modify the dictionary.

## isDatabaseDict

### Declaration

```
bool isDatabaseDict(Dictionary &dict)
```

### Operation

Returns a flag indicating whether the specified dictionary is a database dictionary (`true`) or client dictionary (`false`).

## Miscellaneous Spelling

## anagram

### Declaration

```
bool anagram(string word, int minLength)
```

## Operation

Gets up to a maximum of twenty anagrams of the specified *word*, with the specified minimum length.

Returns a flag indicating if any anagrams were found.

Anagrams are accessed by the same method as getting spelling alternatives.

## Example

```
if (anagram("word", 2))
{
    string s
    for s in alternatives do
    {
        print s "\n"
    }
}
```

## wildcard

### Declaration

```
bool wildcard(string pattern)
```

Gets up to a maximum of twenty wildcards based on the specified *pattern*. The *pattern* string, a '?' matches a single letter, and "\*" matches zero or more letters.

Returns a flag indicating if any wildcard matches were found.

Wildcard matches are accessed by the same method as getting spelling alternatives.

### Example

```
if (wildcard("w?a*d"))
{
    string s
    for s in alternatives do
    {
        print s "\n"
    }
}
```

---

## Spelling\Dictionary Examples

### Example 1

```
//Check single word and show corrections

string result
result = spell("helo")
if (!null result)
{
    print result "\n"
    Buffer suggestion
    for suggestion in alternatives do
    {
        print stringOf(suggestion) "\n"
    }
}
```

### Example 2

```
//Open dictionary and show contents

Dictionary dict
if (null open(dict, databaseDictionary))
{
    print "Words\n"
    Buffer word
    for word in dict do
    {
        print stringOf(word) "\n"
    }

    print "\n"
    AlternativeWord altWord
    Buffer wordBuffer = create
```

```

for altWord in dict do
{
    print stringOf(getWord(altWord, wordBuffer) )
    print " -> "
    print stringOf(getAlternative(altWord, wordBuffer)) "\n"
}
delete wordBuffer
print close(dict, true)
}

```

### Example 3

```
//List names of available languages
```

```

Language language
if (getLanguages > 0)
{
    for language in languages do
    {
        print getName(language) "\n"
    }
}

```

### Example 4

```

//Open user's spell settings and show current language
SpellingOptions options
getOptions(options, userSpellingOptions)
// get the user's current language
int languageId = getLanguage(options)
// get the details for this language
Language language = getLanguage(languageId)

print getName(language) "\n"
// set the language to French and save the options
print setLanguage(options, French)
print saveOptions(options)

```

## Example 5

```
//Show grammar options and active rules
SpellingOptions options
getOptions(options, userSpellingOptions)
int grammarLevel = getGrammarLevel(options)
int checkingMode = getCheckMode(options)

if (grammarLevel == formalGrammar)
    print "Formal \n"
else if (grammarLevel == standardGrammar)
    print "Standard \n"
else
    print "Informal \n"
if (checkingMode == spellingOnly)
    print "Spelling Only\n"
else if (checkingMode == quickProof)
    print "Quick Proof \n"
else
    print "Full Proof \n"
GrammarRules rules = null
int numRules = getGrammarRules(options, rules)
int index
Buffer ruleName = create
for (index = 0; index < numRules; index++)
{
    print stringOf(getName(rules, index, ruleName)) "\n"
}
delete ruleName
```



## Chapter 34

# Database Integrity Checker

This chapter describes the database integrity checker.

- Database Integrity Types
- Database Integrity Perms

---

## Database Integrity Types

---

### IntegrityResultsData

---

This type is a handle to an object that is created and returned by the `checkDatabaseIntegrity` perm (see below), and which contains the results of the integrity check.

### IntegrityCheckItem

---

This type is contained in an ordered list in the `IntegrityResultsData` object. Each item in the list corresponds to the start or completion of the checking of a folder, or a discovered inconsistency (problem) with the data integrity.

### IntegrityProblem

---

This type is contained in a list in the `IntegrityResultsData` object. Each item corresponds to a problematical reference to a hierarchy `Item` by one folder in the hierarchy, or, in the case of orphaned items, to an item that is not referenced by any folder.

### ProblemItem

---

This type is contained in a list in the `IntegrityResultsData` object. Each item corresponds to a hierarchy `Item` that has one or more `IntegrityProblem` records associated with it.

### IntegrityItemType

---

This enumerated type is returned by the `type (IntegrityCheckItem)` and `type (IntegrityProblem)` perms, to identify the meaning of each item.

Both perms can return the following values:

- `referencesInvalidFolder`
- `referencesValidFolder`
- `noDataFound`
- `orphanedItem`.
- `invalidProjectListEntry`
- `missingProjectListEntry`

In addition, the type (`IntegrityCheckItem`) perm can return the following values:

- `startedCheck`
- `completedCheck`
- `failedCheck`

---

## Database Integrity Perms

The Database Integrity functionality is only accessible to administrator users. For any other user, the `checkDatabaseIntegrity` perm (see below) returns null, without performing any database integrity checks.

In general, the following perms generate run-time DXL errors when passed null arguments.

---

### `checkDatabaseIntegrity(Folder&, IntegrityResultsData&)`

---

#### Declaration

```
string checkDatabaseIntegrity(Folder& orphansFolder, IntegrityResultsData&
results)
```

#### Operation

Performs an integrity check on the database, and returns the results in an `IntegrityResultsData` object. Parent/child references are checked for consistency, the database project list is checked for missing items, and the database file system is scanned for orphaned items (data that has become detached from the folder hierarchy, and is therefore no longer accessible to Rational DOORS clients), and these items are placed in the specified orphans folder.

The perm returns null on success, and an error string on failure.

Passing a null argument to this perm causes a run-time error.

Note that the value of the `Folder` argument may be changed by the checking process.

For any user other than administrator, this perm will not perform any checking, and will return an error string and set results to null.

---

## checkFolderIntegrity(Folder, IntegrityResultsData& , bool)

---

### Declaration

```
string checkFolderIntegrity(Folder f, IntegrityResultsData& results, bool
recurse)
```

### Operation

Performs a parent/child reference consistency check on the contents of the specified *folder*, checks for a missing entry in the global project list if the *folder* is a Project, and puts the results in the *IntegrityResultsData* object. If the *recurse* argument is `true`, it performs the same check on all descendants of the folder.

This perm is restricted to administrator users. Error conditions are handled as by the `checkDatabaseIntegrity` perm.

---

## canceled/cancelled(IntegrityResultsData)

---

### Declaration

```
bool canceled/cancelled(IntegrityResultsData results)
```

### Operation

Returns `true` if the integrity check was cancelled by the user pressing the cancel button on the progress bar.

---

## for IntegrityCheckItem in IntegrityResultsData

---

### Declaration

```
for integchkitem in integresdata
```

### Operation

This iterator returns the *IntegrityCheckItem* objects in the order in which they were created during the integrity check. Information from these objects can then be used to compile a report of the integrity check.

---

## for ProblemItem in IntegrityResultsData

---

### Declaration

```
for probitem in integresdata
```

### Operation

This iterator returns an object for each hierarchy item *probitem* for which one or more problems are found.

---

## for IntegrityProblem in ProblemItem

---

### Declaration

```
for integprob in probitem
```

### Operation

This iterator returns an object for each problem found for the same item.

---



---

## for IntegrityProblem in IntegrityResultsData

---

### Declaration

```
for integprob in integresdata
```

### Operation

This returns all `IntegrityProblem` objects in the `IntegrityResultsData` object. These are grouped by unique ID.

---



---

## uniqueID(IntegrityCheckItem)

---

### Declaration

```
string uniqueID(IntegrityCheckItem integchkitem)
```

### Operation

This returns the index of the item to which the `IntegrityCheckItem` applies. For `Started/Failed/CompletedCheck` items, it refers to the folder whose contents are being checked. For others, it refers to the item in the folder that exhibits a problem.

---



---

## uniqueID(IntegrityProblem)

---

### Declaration

```
string uniqueID(IntegrityProblem integprob)
```

### Operation

This returns the index of the item that exhibits the problem.

---



---

## uniqueID(ProblemItem)

---

### Declaration

```
string uniqueID(ProblemItem probitem)
```

## Operation

This returns the index of the problem item *problem*.

### problems(IntegrityResultsData, string)

#### Declaration

```
ProblemItem problems(IntegrityResultsData integresdata, string uniqueID)
```

#### Operation

This is the converse of the unique ID perm above, returning the *ProblemItem* for a given index. It returns null if no problems are listed in the *IntegrityResultsData* variable for the given Item index.

### timestamp(IntegrityCheckItem)

#### Declaration

```
Date timestamp(IntegrityCheckItem integchkitem)
```

#### Operation

This returns the timestamp (date and time) indicating when the *IntegrityCheckItem* was generated.

### folder(IntegrityProblem)

#### Declaration

```
Folder folder(IntegrityProblem integprob)
```

#### Operation

Returns the parent folder that contains the problematical reference. It returns null for orphaned items.

### type(IntegrityCheckItem)

#### Declaration

```
IntegrityItemType type(IntegrityCheckItem integchkitem)
```

#### Operation

Can return any one of the following values:

- referencesInvalidFolder
- referencesValidFolder
- noDataFound
- orphanedItem

- `invalidProjectListEntry`
- `missingProjectListEntry`
- `startedCheck`
- `completedCheck`
- `failedCheck`

---

## type(IntegrityProblem)

---

### Declaration

`IntegrityItemType type(IntegrityProblem integprob)`

### Operation

Can return any one of the following values:

- `referencesInvalidFolder`
- `referencesValidFolder`
- `noDataFound`
- `orphanedItem`
- `invalidProjectListEntry`
- `missingProjectListEntry`

---

## type(ProblemItem)

---

### Declaration

`IntegrityItemType type(ProblemItem probitem)`

### Operation

Returns the type of the first problem associated with the specified item *probitem*. It can return any one of the following values:

- `referencesInvalidFolder`
- `referencesValidFolder`
- `noDataFound`
- `orphanedItem`
- `invalidProjectListEntry`
- `missingProjectListEntry`

---

## text(IntegrityCheckItem)

---

### Declaration

```
string text(IntegrityCheckItem integchkitem)
```

### Operation

Returns the error message string (if any) for the given IntegrityCheckItem.

---

## parentRefID(IntegrityProblem | ProblemItem)

---

### Declaration

```
string parentRefID(IntegrityProblem integprob| ProblemItem probitem)
```

### Operation

Returns the index of the parent referenced by the problem item's data.

---

## parentRef(IntegrityProblem | ProblemItem)

---

### Declaration

```
Folder parentRef(IntegrityProblem integprob| ProblemItem probitem)
```

### Operation

Returns the folder that the problem item references as its parent, if the folder exists.

---

## setParent(ProblemItem, Folder)

---

### Declaration

```
string setParent(ProblemItem probitem, Folder f)
```

### Operation

Sets the parent of the item referenced by the ProblemItem to the specified folder, removing all references in any other folders that are known to list the item in their contents (other parent folders associated with IntegrityProblems for the same ProblemItem). The perm returns null on success, and an error string on failure. If the specified Folder does not already contain a reference to the item, then a reference is added. The affected IntegrityProblems are marked as repaired (see below).

If the ProblemItem type is noDataFound, then the Folder argument can be null, in which case all folder entries are removed. If the ProblemItem type is noDataFound and the folder argument is not null, new data is created if the item is a Project or Folder.

---

## addProjectEntry(ProblemItem)

---

### Declaration

```
string addProjectEntry(ProblemItem probitem)
```

### Operation

If the `ProblemItem` includes a "missingProjectListEntry" problem, this perm adds the missing entry in the global project list. On successful completion, it marks any `missingProjectListEntry` problems for the `ProblemItem` as repaired, and returns null. On failure, it returns an error message.

If the entry name matches an existing entry (project), or a top-level folder in the database, then the project is renamed by appending a space and a decimal integer (defaulting to 1, but incremented as required to achieve uniqueness).

---

## convertToFolder(ProblemItem)

---

### Declaration

```
string convertToFolder(ProblemItem probitem)
```

### Operation

If the `ProblemItem` includes a `missingProjectListEntry` problem, this perm converts the referenced Project to a Folder. In the case of duplicate references to the item, this is done for all known references. On successful completion, the perm marks the affected `IntegrityProblems` as repaired, and returns null. On failure, it returns an error message.

---

## repaired(IntegrityProblem)

---

### Declaration

```
bool repaired(IntegrityProblem integprob)
```

### Operation

Returns `true` if the problem described by the specified `IntegrityProblem` has been repaired by the `setParent` perm.

---

## repaired(ProblemItem)

---

### Declaration

```
bool repaired(ProblemItem probitem)
```

### Operation

Returns `true` if all of the problems associated with the specified `IntegrityProblem` have been repaired by the `setParent` perm.



---

## delete(IntegrityResultsData&)

---

### Declaration

```
string delete(IntegrityResultsData& integresdata)
```

### Operation

Deletes the `IntegrityResultsData` object and sets its value to null.

---

## checkItem(IntegrityProblem)

---

### Declaration

```
IntegrityCheckItem checkItem(IntegrityProblem integprob)
```

### Operation

Returns an `IntegrityCheckItem` reference, for the given `IntegrityProblem`. The returned value can be passed to any perm or function taking an `IntegrityCheckItem` argument.

---

## everSectioned

---

### Declaration

```
bool everSectioned({ModName_ | ModuleVersion})
```

### Operation

Reports whether the specified `ModName_` or `ModuleVersion` shows evidence that the module was ever save with shareable sections. If a supplied `ModuleVersion` references a baseline, rather than a current version, false will be returned.



## Chapter 35

# Discussions

This chapter describes features that operate on Rational DOORS discussions:

- Discussion Types
- Properties
- Iterators
- Operations
- Triggers
- Discussions access controls
- Example

---

## Discussion Types

---

---

### Discussion

---

Represents a discussion.

---

### Comment

---

Represents a comment in a discussion.

---

### DiscussionStatus

---

Represents the status of a discussion. The possible values are `Open` and `Closed`.

---

## Properties

The following tables describe the properties available for the `Discussion` and `Comment` types. Property values can be accessed using the `.` (dot) operator, as shown in the following syntax:

*variable.property*

where:

*variable* is a variable of type `Discussion` or `Comment`

*property* is one of the discussion or comment properties

---

## Discussion

---

Property	Type	Extracts
<code>status</code>	<code>DiscussionStatus</code>	The status of the discussion: whether it is open or closed.
<code>summary</code>	<code>string</code>	The summary text of the discussion, which may be null
<code>createdBy</code>	<code>User</code>	The user who created the discussion, if it was created in the current database. Otherwise it returns null.
<code>createdByName</code>	<code>string</code>	The name of the user who created the discussion, as it was when the discussion was created.
<code>createdByFullName</code>	<code>string</code>	The full name of the user who created the discussion, as it was when the discussion was created.
<code>createdOn</code>	<code>Date</code>	The date and time the discussion was created.
<code>createdDataTimestamp</code>	<code>Date</code>	The last modification timestamp of the object or module that the first comment in the discussion referred to.
<code>lastModifiedBy</code>	<code>User</code>	The user who added the last comment to the discussion, or who last changed the discussion status
<code>lastModifiedByName</code>	<code>string</code>	The user name of the user who added the last comment to the discussion, or who last changed the discussion status.
<code>lastModifiedByFullName</code>	<code>string</code>	The full name of the user who added the last comment to the discussion, or who last changed the discussion status.
<code>lastModifiedOn</code>	<code>Date</code>	The date and time the last comment was added, or when the discussion status was last changed.
<code>lastModifiedDataTimestamp</code>	<code>Date</code>	The last modification timestamp of the object or module that the last comment in the discussion referred to.

---

Property	Type	Extracts
<code>firstVersion</code>	<code>ModuleVersion</code>	The version of the module the first comment was raised against.  <b>Note:</b> If a comment is made against the current version of a module and the module is then baselined, this property will return a reference to that baseline. If the baseline is deleted, it will return the deleted baseline.
<code>lastVersion</code>	<code>ModuleVersion</code>	The version of the module the latest comment was raised against. See note for the <code>firstVersion</code> property above.
<code>firstVersionIndex</code>	<code>string</code>	The baseline index of the first module version commented on in the discussion. Can be used in comparisons between module versions.
<code>lastVersionIndex</code>	<code>string</code>	The baseline index of the last module version commented on in the discussion. Can be used in comparison between module versions.

---

## Comment

---

Property	Type	Extracts
<code>text</code>	<code>string</code>	The plain text of the comment.
<code>moduleVersionIndex</code>	<code>string</code>	The baseline index of the module version against which the comment was raised. Can be used in comparisons between module versions.
<code>status</code>	<code>DiscussionStatus</code>	The status of the discussion in which the comment was made.
<code>moduleVersion</code>	<code>ModuleVersion</code>	The version of the module against which the comment was raised.  <b>Note:</b> If a comment is made against the current version of a module and the module is then baselined, this property will return a reference to that baseline. If the baseline is deleted, it will return the deleted baseline.
<code>onCurrentVersion</code>	<code>bool</code>	True if the comment was raised against the current version of the module or an object in the current version.

Property	Type	Extracts
<code>changedStatus</code>	<code>bool</code>	Tells whether the comment changed the status of the discussion when it was submitted. This will be true for comments which closed or re-opened a discussion.
<code>dataTimestamp</code>	<code>Date</code>	The last modified time of the object or module under discussion, as seen at the commenting users client at the time the comment was submitted.
<code>createdBy</code>	<code>User</code>	The user that created the comment. Returns null if the user is not in the current user list.
<code>createdByName</code>	<code>string</code>	The user name of the user who created the comment, as it was when the comment was created.
<code>createdByFullName</code>	<code>string</code>	The full name of the user who created the comment, as it was when the comment was created.
<code>createdOn</code>	<code>Date</code>	The data and time when the comment was created.
<code>discussion</code>	<code>Discussion</code>	The discussion containing the comment.

---

## Iterators

---

### for Discussion in Type

---

#### Syntax

```
for disc in Type do {
  ...
}
```

where:

*disc* is a variable of type `Discussion`

*Type* is a variable of type `Object`, `Module`, `Project` or `Folder`

#### Operation

Assigns the variable *disc* to be each successive discussion in *Type* in the order they were created. The first time it is run the discussion data will be loaded from the database.

The `Module`, `Folder` and `Project` variants will not include discussions on individual objects.

**Note:** The `Folder` and `Project` variants are provided for forward compatibility with the possible future inclusion of discussions on folders and projects.

---

## for Comment in Discussion

---

### Syntax

```
for comm in disc do {
  ...
}
```

where:

*comm* is a variable of type `Comment`  
*disc* is a variable of type `Discussion`

### Operation

Assigns the variable *comm* to be each successive comment in *disc* in chronological order. The first time it is run on a discussion in memory, the comments will be loaded from the database. Note that if a discussion has been changed by a refresh (e.g. in terms of the last `Comment` timestamp) then this will also refresh the comments list.

The discussion properties will be updated in memory if necessary, to be consistent with the updated list of comments.

---

## Operations

---

### create(Discussion)

---

#### Declaration

```
string create(target, string text, string summary, Discussion& disc)
```

#### Operation

Creates a new `Discussion` about *target*, which can be of type `Object` or `Module`. Returns null on success, error string on failure. Also add *text* as the first comment to the discussion.

---

### addComment

---

#### Declaration

```
string addComment(Discussion disc, target, string text, Comment& comm)
```

## Operation

Adds a `Comment` about *target* to an open `Discussion`. Note that *target* must be an `Object` or `Module` that the `Discussion` already relates to. Returns null on success, error string on failure.

## closeDiscussion

### Declaration

```
string closeDiscussion(Discussion disc, target, string text, Comment& comm)
```

### Operation

Closes an open `Discussion` *disc* by appending a closing comment, specified in *text*. Note that *target* must be an `Object` or `Module` that *disc* already relates to. Returns null on success, error string on failure.

## reopenDiscussion

### Declaration

```
string reopenDiscussion(Discussion disc, target, string text, Comment& comm)
```

### Operation

Reopens a closed `Discussion` *disc* and appends a new comment, specified in *text*. Note that *target* must be an `Object` or `Module` that *disc* already relates to. Returns null on success, error string on failure.

## deleteDiscussion

### Declaration

```
string deleteDiscussion(Discussion d, Module m|Object o)
```

### Operation

Deletes the specified module or object discussion if the user has the permission to do so. Returns null on success, or an error string on failure.

## sortDiscussions

### Declaration

```
void sortDiscussions({Module m|Object o|Project p|Folder f}, property, bool ascending)
```

### Operation

Sorts the discussions list associated with the specified item according to the given *property*, which may be a date, or a string property as listed in the discussions properties list. String sorting is performed according to the lexical ordering for the current user's default locale at the time of execution.



If the discussion list for the specified item has not been loaded from the database, this perm will cause it to be loaded.

**Note:** The Folder and Project forms are provided for forward compatibility with the possible future inclusion of discussions on folders and projects.

## getDiscussions

### Declaration

```
string getDiscussions({Module m|Object o|Project p|Folder f})
```

### Operation

Refreshes from the database the `Discussion` data for the specified item in memory. Returns null on success, or an error on failure.

## getObjectDiscussions

### Declaration

```
string getObjectDiscussions(Module m)
```

### Operation

Refreshes from the database all `Discussions` for all objects in the specified module. Returns null on success, or an error on failure

## getComments

### Declaration

```
string getComments(Discussion d)
```

### Operation

Refreshes from the database the comments data for the specified `Discussion` in memory. Returns null on success, or an error on failure.

**Note:** The `Discussion` properties will be updated if necessary, to be consistent with the updated comments list.

## mayModifyDiscussionStatus

### Declaration

```
bool mayModifyDiscussionStatus(Discussion d, Module m)
```

### Operation

Checks whether the current user has rights to close or re-open the specified discussion on the specified module.

---

## baselineIndex

---

### Declaration

```
string baselineIndex(Module m)
```

### Operation

Returns the baseline index of the specified `Module`, which may be a baseline or a current version. Can be used to tell whether a `Comment` can be raised against the given `Module` data in a given `Discussion`.

**Note:** A `Comment` cannot be raised against a baseline index which is less than the `lastVersionIndex` property of the `Discussion`.

---

## isDiscussionColumn

---

### Declaration

```
bool isDiscussionColumn(Column c)
```

### Operation

Returns true if the column is a discussion column, otherwise false.

---

## setDiscussionColumn

---

### Declaration

```
void setDiscussionColumn(Column c, string s)
```

### Operation

Sets the filter on the discussion column based on the supplied discussion DXL filename.

### Example

```
Column c
for c in current Module do
{
    if (isDiscussionColumn(c))
    {
        string s = dxlFilename(c)
        if (s != null)
        {
            Module m = edit("/TestDiscussions ", true)
//Open a module, with some discussions in it.
```

```

if (m != null)
{
    Column cNew = insert(column 3)
    title(cNew, "My copy Discussion")
    string home = getenv("HOME")
    string fullPath = home "\\\" s ""
    string contents = readFile(fullPath)
//Call dxl PERM on that column before setting the discussion column. The
//discussion column is also a modified version of LAYOUT dxl.
    dxl(cNew, contents)
    setDiscussionColumn(cNew, s)
    width(cNew, 100)
    refresh(m, false)
}
}
}
}
}

```

---

## Triggers

Trigger capabilities have been expanded so that triggers can now be made to fire before or after a Discussion or a Comment is created.

As follows:

	<b>pre</b>	<b>post</b>
Comment	x	x
Discussion	x	x

---

### comment

---

#### Declaration

Comment comment(Trigger t)

#### Operation

Returns the Comment with which the supplied Trigger is associated, null if not a Comment trigger.

---

## discussion

---

### Declaration

```
Discussion discussion(Trigger t)
```

### Operation

Returns the `Discussion` with which the supplied `Trigger` is associated, null if not a `Discussion` trigger.

---

## dispose(Discussion/Comment)

---

### Declaration

```
void dispose({Discussion& d|Comment& c})
```

### Operation

Disposes of the supplied `Comment` or `Discussion` reference freeing the memory it uses.

Can be called as soon as the reference is no longer required.

**Note:** The disposing will take place at the end of the current context.

---

## Discussions access controls

This section describes functions that report on access rights for discussions.

---

## canModifyDiscussions

---

### Declaration

```
bool canModifyDiscussions({Module m| Item i| string s}[, {User |string}})
```

### Operation

Returns true if a given user or named user (current user if the parameter is not supplied) is allowed to create a discussion or a comment on a discussion for the given module, item or named module. The use of `item` is intended for use when the `Item` represents a module.

---

## canEveryoneModifyDiscussions

---

### Declaration

```
bool canEveryoneModifyDiscussions({Module m| Item i})
```

## Operation

Returns true if the discussions access list for the given module or item contains the special "Everyone" group.

---

## addUser

---

### Declaration

```
void addUser(Item i, {User u| string s})
```

### Operation

Adds the user or named user to the Discussion Access List for an Item. The updated list is not saved in the database until `saveDiscussionAccessList` is called.

---

## addGroup

---

### Declaration

```
void addGroup(Item i, {Group g| string s})
```

### Operation

Adds the group or named group to the Discussion Access List for an Item. The updated list is not saved in the database until `saveDiscussionAccessList` is called.

---

## removeUser

---

### Declaration

```
void RemoveUser(Item i, {User u| string s})
```

### Operation

Remove the user or named user from the Discussion Access List for an Item. The updated list is not saved in the database until `saveDiscussionAccessList` is called.

---

## removeGroup

---

### Declaration

```
void removeGroup(Item i, {Group g| string s})
```

### Operation

Remove the group or named group from the Discussion Access List for an Item. The updated list is not saved in the database until `saveDiscussionAccessList` is called.

---

## saveDiscussionAccessList

---

### Declaration

```
string saveDiscussionAccessList(Item i)
```

### Operation

This perm saves the discussion access list for the given item to the database. This perm is only successful for an administrator or a user with Manage Database privileges. If the call is successful, a null value will be returned, otherwise a string with an error message will be returned.

---

## Example

```
// Create a Discussion on the current Module, with one follow-up Comment...
Module m = current
Discussion disc = null
create(m, "This is my\nfirst comment.", "First summary", disc)
Comment cmt
addComment(disc, m, "This is the\nsecond comment.", cmt)

// Display all Discussions on the Module
for disc in m do
{
    print disc.summary " (" disc.status ") \n"
    User u = disc.createdBy
    string s = u.name
    print "Created By: " s "\n"
    print "Created By Name: \"" disc.createdByName "\" \n"
    print "Created On: " stringOf(disc.createdOn) "\n"
    u = disc.lastModifiedBy
    s = u.name
    print "Last Mod By: " s "\n"
    print "Last Mod By Name: \"" disc.lastModifiedByName "\" \n"
    print "Last Mod On " stringOf(disc.lastModifiedOn) "\n"
```

```

print "First version: " (fullName disc.firstVersion) " [" //-
    (versionString disc.firstVersion) "]\n"
print "Last version: " (fullName disc.lastVersion) " ["
    (versionString disc.lastVersion) "]\n"

Comment c
for c in disc do
{
print "Comment added by " (c.createdByName) " at " //-
    (stringOf(c.createdOn)) ":\n"
print "Module Version: " (fullName c.moduleVersion) " [" //-
    (versionString c.moduleVersion) "]\n"
print "Data timestamp: " (stringOf c.dataTimestamp) "\n"
print "Status: " c.status " (" (c.changedStatus ? "Changed" //-
    : "Unchanged") ")\n"
print "On current: " c.onCurrentVersion "\n"
print c.text "\n"
}
}

```





## Chapter 36

# General functions

This chapter describes functions that do not belong to any major grouping.

- Error handling
- Archive and restore
- Checksum validation
- Locking
- HTML functions
- HTTP Server
- Asynchronous HTTP requests
- OSLC DXL Services
- Broadcast Messaging
- Converting a symbol character to Unicode
- Timer

---

## Error handling

This section defines functions for handling errors.

When parse time errors occur when running DXL scripts, the `#include` nesting of files is reported, in addition to the file and line number of the error.

Take two DXL files, `c:\temp\a.dxl` and `c:\temp\b.dxl`:

```
//file a.dxl
#include <c:\temp\b.dxl>
//file b.dxl
while //syntax error
```

Execute the DXL statement:

```
#include <c:\temp\a.dxl>
```

This returns:

```
-E- DXL: <c:\temp\b.dxl:2> syntax error
Included from:
    <c:\temp\a.dxl:1>
```

```
<Line:1>
```

```
-I- DXL: all done with 1 error and 0 warnings
```

Notice that the file containing the error is displayed first, followed by a list of ‘included from’ files.

For run-time error reports of DXL scripts, the function backtrace, or callstack, is reported.

Run the following DXL program:

```
void f()
{
    string s
    print s
}
```

```
void g()
{
    f
}
```

```
g
```

The result will be:

```
-R-E- DXL: <Line:4> unassigned variable (s)
```

```
Backtrace:
```

```
<Line:9>
```

```
<Line:12>
```

```
-I- DXL: execution halted
```

Notice that there is a backtrace showing the function call nesting at the time the runtime error occurred.

## error

### Declaration

```
void error(string message)
```

### Operation

Terminates the current DXL program, prints the string *message* in the DXL Interaction window’s output pane, and pops up a modal dialog box, which announces the presence of errors.

### Example

```
error "No links to trace"
```

---

## lastError

---

### Declaration

```
string lastError()
```

### Operation

Returns the last error as a string. If the `noError` function has been called, certain key functions do not fail and halt when they discover an error condition. Instead, they set an error message, which can be checked by this function. Calling `lastError` terminates `noError`.

Returns null if there are no errors.

This function can be used to turn error box messages back on after the function has been used.

### Example

```
noError
Module m = share("Key data", false)
string openStatus = lastError
if (null openStatus) {
// we opened the module for full access
} else {
// some one has the module open for edit
}
```

---

## noError

---

### Declaration

```
void noError()
```

### Operation

Switches off DXL run-time errors until `lastError` is called. Any function that can produce a run-time error is affected. Instead of failing and halting when they discover an error condition, they set an error message, which can be checked by the `lastError` function.

Calling this function resets the error message to null, so you must store any potential error messages for reuse.

---

## unixerror

---

### Declaration

```
void unixerror(string message)
```

### Operation

Similar to the `error` function except that the last known operating system error is printed, as well as the string `message`.

The name `unixerror` is not well chosen, because the function works correctly on all Rational DOORS platforms. The name is derived from the UNIX  `perror`  function.

### Example

```
Stat s = create "/no-such-file"
if (null s) unixerror "trouble with filename: "
```

## warn

### Declaration

```
void warn(string message)
```

### Operation

Similar to the `error` function except that the program is not halted.

## dxlHere()

### Declaration

```
string dxlHere()
```

### Operation

This returns the file and line of DXL code currently being executed. Useful for debugging DXL scripts. It only returns the file information for DXL scripts executed by using the `#include` mechanism.

### Example

```
print dxlHere() "\n"
```

## Archive and restore

This section defines properties, constants, and functions for use with Rational DOORS archive and restore. Two main data types are introduced:

<code>ArchiveItem</code>	An item in an archive
<code>ArchiveData</code>	A list of the contents of an archive

## Archive properties

Properties are defined for use with the `.` (dot) operator and `ArchiveItem` structure to extract information about archives, as shown in the following syntax:

*archiveItem.property*

where:

*archiveItem*      Is a variable of type ArchiveItem  
*property*          Is one of the archive properties

The following tables list the properties and the information they extract.

<b>String property</b>	<b>Extracts</b>
<code>archiveItemName</code>	The name of the archive item
<code>archiveItemDescription</code>	The description of the archive item
<code>archiveItemType</code>	The type of the archive item

---

<b>Boolean property</b>	<b>Extracts</b>
<code>archiveItemSelected</code>	Whether the item is selected
<code>archiveItemSoftDeleted</code>	Whether the item is soft deleted

---



---

## for archive item in archive

---

### Syntax

```
for archiveItem in archive do {
...
}
```

where:

*archiveItem*      Is a variable of type ArchiveItem  
*archive*            Is a variable of type ArchiveData

### Operation

Assigns *archiveItem* to be each successive archive item in *archive*.

### Example

```
ArchiveData archiveData
string message
message = get("c:\\project.dpa", archiveData)
ArchiveItem archiveItem
```

```

for archiveItem in archiveData do {
    if (archiveItem.archiveItemName ==
        "my module" ) {
        if (archiveItem.archiveItemSelected) {
            deselect(archiveItem)
        }
    }
}

```

---

## archive(modules and projects)

---

### Declaration

```

string archive(string projectName,
               string fileName,
               bool span
               [, bool incBackups,
                ArchiveInclusionDescriptor allbaselines/noBaselines
                [, bool serverArchive]])

```

```

string archive(ModName_ modRef,
               string fileName,
               bool span)
               [, bool incBackups,
                ArchiveInclusionDescriptor allbaselines/noBaselines
                [, bool serverArchive]])

```

```

string archive(string projectName,
               string user,
               string password,
               string fileName,
               bool span)

```

### Operation

The first form creates an archive of the project *projectName*, and puts it in *fileName*. The default file type is *.dpa*.

The second form creates an archive of the module named *modRef*, and puts it in *fileName*. The default file type is *.dma*.

The third form creates an archive of the project *projectName*, and puts it in *fileName*. This form is supported only for compatibility with earlier releases.

The optional *incBackups* parameter can be used to specify whether database backup files are to be included in the archive.

The optional *ArchiveInclusionDescriptor* parameter can be used to specify whether baselines will be included in the archive.

The optional *serverArchive* parameter can be used to specify whether the archive will be created in the database server-side archive location.

If *span* is true and the path specified is on a removable disk, the archive spans multiple disks.

## Example

This example archives a module:

```
string message = archive(module "Car", "d:\\temp\\car.dma", false)
if (!null message) {
    ack message
    halt
}
```

This example archives a project:

```
string message = archive ("Car project",
                          "a:\\car_project.dpa", true)
if (!null message) {
    ack message
    halt
}
```

---

## archive(user list)

---

### Declaration

```
string archive(string fileName,
               bool span)
```

### Operation

Creates an archive of the user list, and puts it in *fileName*. The default file type is .dua.

---

## archiveFiles

---

### Declaration

```
string archiveFiles(string fileName,
                    string dir,
                    bool span)
```

### Operation

Archives the files recursively from the directory *dir* into the zip file *fileName*. The zip file is compatible with pkzip.

If *span* is true and the path specified is on a removable disk, the archive spans multiple disks.

## Example

This example archives all the files in a directory:

```
string message
```

```

message = archiveFiles("d:\\temp\\temp.zip",
    "d:\\temp\\archive\\", false)

if (! null message) {
    ack message
    halt
}

```

---

## getArchiveType

---

### Declaration

```

string getArchiveType(string fileName,
    ZipType& zip, [bool serverArchive])

```

### Operation

Returns the type of archive file as one of the following constants:

zipNotArchive	Archive is not a project or module
zipProjectArchive	Project archive
zipModuleArchive	Module archive
zipPre3ProjectArchive	Project archived under a version of Rational DOORS prior to 3.0
zipPre3ModuleArchive	Module archived under a version of Rational DOORS prior to 3.0
zipPre5ProjectArchive	Project archived under a version of Rational DOORS prior to 5.0
zipPre5ModuleArchive	Module archived under a version of Rational DOORS prior to 5.0
zipProject5Archive	Project archived under Rational DOORS 5.x
zipModule5Archive	Module archived under Rational DOORS 5.x
zipUserListArchive	User list archive
zipUserList5Archive	User list archived under Rational DOORS 5.x

### Example

This example finds out whether a zip file is a project archive:

```

string file = "d:\\temp\\temp.dpa"
string message
ZipType zip
message = getArchiveType(file, zip)

if (!null message){
    print "Failed: " message "\n"
    halt
}

```



```

if (zip == zipProjectArchive) {
    print file " is a project archive from the
               latest DOORS version"
} else if (zip == zipProject5Archive) {
    print file " is a project archive from DOORS
               version 5"
} else {
    print file " is neither a version 5 nor a
               version 6 project archive"
}

```

---

## getModuleDetails

---

### Declaration

```

string getModuleDetails(string fileName,
                       string &moduleName,
                       string &projectName,
                       [string &databaseID,
                       string &databaseName,]
                       Date &archiveDate, [bool serverArchive], [ZipType& zt] [])

```

### Operation

Passes back module details from the archive *fileName*. Module details comprise the module name, the project name from which it originates, and the archive date. If the optional arguments *databaseID* and *databaseName* are supplied, the function passes back the database ID and name.

If the archive is not a module archive, the function passes back a null string for any parameter it cannot identify, and sensible results for the rest.

The last two flags are for indicating that the archive file is on the server and an additional pointer to a variable used to return the type of zip to the caller.

If *serverArchive* flag is set to `true` and the user does not have permission to read a server archive, an error message will be returned.

If the call fails, the function returns an error message.

### Example

This example passes back the details of the module archived in `d:\temp\car.dma`.

```

string moduleName
string projectName
Date archiveDate
string mess= getModuleDetails("d:\\temp\\car.dma", modName,
                             projName, archiveDate)

```

```

if (!null message) {
    ack message
    halt
} else {
    string d = archiveDate ""
    print "The archived file contains the module
        " moduleName "
    print "and was archived from "
    print "the project " projectName " on the " d
        "\n"
}

```

---

## getProjectDetails

---

### Declaration

```

string
getProjectDetails(string fileName,
                  string &projectName,
                  string &projectDescription,
                  [string &databaseID,
                  string &databaseName,]
                  Date &archiveDate,[bool serverArchive],[ZipType& zt])

```

### Operation

Gets project details from the archive *fileName*. Project details are the name, description and archive date of the project that was archived. If the optional arguments *databaseID* and *databaseName* are supplied, the function passes back the database ID and name in them.

If the archive is not a project archive, the function passes back a null string for any parameter it cannot identify, and sensible results for the rest.

The last two flags are for indicating that the archive file is on the server and an additional pointer to a variable used to return the type of zip to the caller.

If *serverArchive* flag is set to `true` and the user does not have permission to read a server archive, an error message will be returned.

If the call fails, the function returns an error message.

### Example

This example gets the details of the project archived in a `: \car_project.dpa`.

```

string projectName
string projectDescription
Date archiveDate
string databaseId
string databaseName

```

```

message=getProjectDetails("a:\\car_project.zip", projectName,
projectDescription, databaseId, databaseName,
archiveDate)
if (!null message) {
    ack message
    halt
} else {
    string d = archiveDate ""
    print "The archived file contains the project
    "projectName
    print "with the description "
    projectDescription
    print " from the database called "
    databaseName
    print " with database ID" databaseId
    print "on the " d "\n"
}

```

---

## getUserlistDetails

---

### Declaration

```

string getUserlistDetails(string fileName,
                        string &databaseId,
                        string &databaseName,
                        Date &archiveDate)

```

### Operation

Gets user list details from the archive *fileName*. User list details are the ID and name of the database from which the archive was taken.

If the archive is not a user list archive, the function passes back a null string for any parameter it cannot identify, and sensible results for the rest.

If the call fails, the function returns an error message.

---

## restore(archive)

---

### Declaration

```

string restore(ArchiveData archive
              [,string archiveName], [bool serverArchive])

```

### Operation

Restores *archive* to *archiveName*. If the operation succeeds, returns a null string; otherwise, returns an error message.

For a project archive, if you specify *archiveName*, this must be a non-existent location. The function then creates a project with this name, and restores the contents of the archive but not the project itself, into the new project. If you do not specify *archiveName*, the function uses the name of the archived project, and restores it to the current location.

For a module archive, if you specify *archiveName*, this must be an existing location. The function then creates the module archive in this existing folder or project. If you do not specify *archiveName*, the function restores the module to the current location.

For a user list archive, if you specify *archiveName*, it is ignored.

The *serverArchive* flag is an additional flag indicating that the archive file is on the server.

If *serverArchive* flag is set to `true` and the user does not have permission to read a server archive, an error message will be returned.

## restoreModule

### Declaration

```
string restoreModule(string fileName
                    [,string moduleName], [bool serverArchive])
```

### Operation

Restores a module from the archive file *fileName*. Optionally renames the module to the name *moduleName*.

If you are restoring a module without defining its name, it can only be restored into a project that does not already contain a module of that name.

If you are restoring a module with a defined name, the *moduleName* must be unique within the restored folder.

The flag *serverArchive* indicates that the archive file is on the server.

If *serverArchive* flag is set to `true` and the user does not have permission to read a server archive, an error message will be returned.

### Example

This example restores a module from `d:\temp\car.dma`.

```
string message = restore "d:\\temp\\car.dma"
if (!null message) {
    ack message
    halt
}
```

This example restores a module from `d:\temp\car.dma` to the module `Car user reqts 2`.

```
string message = restore("d:\\temp\\car.dma", "Car user reqts 2")
if (!null message) {
    ack message
    halt
}
```

---

## restoreFiles

---

### Declaration

```
string restoreFiles(string fileName,
                   string destination)
```

### Operation

Restores all the files from the zip file *fileName* to the specified directory *destination*.

### Example

This example restores all the files from a zip file.

```
string
    message = restoreFiles("d:\\temp\\temp.zip",
                          "d:\\temp\\new\\")

if (message !=null) {
    ack message
    halt
}
```

---

## restoreProject

---

### Declaration

```
string
restoreProject(string fileName
              [,string projectName
              [,string projectDescription]], [bool serverArchive])
```

### Operation

Restores a project from the archive file *fileName*, optionally renaming the project to *projectName* with the description *projectDescription*.

If you are restoring a project without defining its name, it can only be restored into a database that does not already contain a project of that name.

If you are restoring a project with a defined name and description, the *projectName* must be unique.

### Example

This example restores the project `Car` project from the file `a:\car_project.dpa`.

```
string message = restore "a:\car_project.dpa"

if (!null message) {
    ack message
    halt
}
```

This example restores a project from `a:\car_project.dpa` to the project `Car project 2` with the description `Restored project`.

```
string message=restore("a:\\car_project.dpa", "Car project 2", "Restored
project")
if (message != null) {
    ack messagehalt
}
```

## restoreUserlist

### Declaration

```
string restoreUserlist(string fileName)
```

### Operation

Restores the user list from the archive file *fileName*.

## select(archive item)

### Declaration

```
bool select(ArchiveItem item)
```

### Operation

Selects *item*. If the operation succeeds, returns `true`; otherwise, returns `false`.

## deselect(archive item)

### Declaration

```
bool deselect(ArchiveItem item)
```

### Operation

Deselects *item*. If the operation succeeds, returns `true`; otherwise, returns `false`.

## rename(archive item)

### Declaration

```
bool rename(ArchiveItem item,
            string newName)
```

### Operation

Renames *item* to *newName*. If the operation succeeds, returns `true`; otherwise, returns `false`.

---

## get(archive data)

---

### Declaration

```
string get(string fileName,  
           ArchiveData &archive, [bool serverArchive])
```

### Operation

Retrieves the archive data structure from the given file. If the operation succeeds, returns a null string; otherwise, returns an error message.

The *serverArchive* flag indicates that the archive file is on the server.

If *serverArchive* flag is set to `true` and the user does not have permission to read a server archive, an error message will be returned.

---

## canCreateServerArchive

---

### Declaration

```
bool canCreateServerArchive()
```

### Operation

Returns `true` if the current user has permission to create an archive at the server and the server has been set up with the archive directory defined.

---

## canRestoreServerArchive

---

### Declaration

```
bool canRestoreServerArchive()
```

### Operation

Returns `true` if the current user has permission to restore an archive from the server and the server has been set up with the archive directory defined.

---

## canReadServerArchiveFile

---

### Declaration

```
string canReadServerArchiveFile(string s)
```

### Operation

Used to test for an archive existing and being available on the server before attempting a restore operation. The filename supplied is relative to the archive directory on the server.

Returns NULL if the file exists and can be read or a non-null error message if the specified file cannot be accessed on the server.

---

## canWriteServerArchiveFile

---

### Declaration

```
string canWriteServerArchiveFile(string s)
```

### Operation

Used to test for an archive being available to write to on the server before attempting an archive operation. The filename supplied is relative to the archive directory on the server.

Returns NULL if the file can be written or a non-null error message if the specified file cannot be written to on the server. Overwriting server archives is not permitted so if the file already exists, this will return an error message.

---

## canUseServerArchive

---

### Declaration

```
string canUseServerArchive()
```

### Operation

Used to return a string indicating if server archiving by the current user is allowed.

Returns a string indicating if server archiving is permitted and, if it is not permitted, why it is not.

The reasons server archiving may not be permitted are:

Message	Description
Server archiving not allowed - directory not defined	DOORS_ARCHIVE_LOCATION has not been defined
Server archive directory does not exist	The directory defined in DOORS_ARCHIVE_LOCATION does not exist or is not a sub-directory of SERVERDATA.
No permission to restore a server archive	The archive directory is valid but the user does not have permission to archive on the server.

If archiving is permitted, the following message is returned:

```
User has permission and directory is defined
```



---

## Checksum validation

The checksum validation functions enable you to create a validation record for a module before you export or archive the module. The checksum function generates XML files in a compressed file with a .zip extension. The output identifies a module name, description, and location. The output also lists selected views for the module and the object attributes that are used in those views. Links, OLE objects, and images are not referenced in the generated output. When the module is later imported or restored to the project, you can then compare the checksum validation record with the module to identify changes to the text or other attribute values in the selected views.

---

### createChecksumFile

---

#### Declaration

```
bool createChecksumFile(DB box, Module mod, Skip viewList, string fileName,
string& returnStr)
```

#### Operation

Creates a compressed file with a .zip extension that contains XML files that describe a module, selected views within the module, and object attributes that are associated with objects in those views.

The `createChecksumFile` declaration includes the following parameters:

- The `DB box` parameter is optional. This parameter is used to display a progress bar while the checksum file is generated. If this parameter is not included in the declaration, then the progress bar is not shown.
- The `Module mod` parameter identifies the module from which the checksum file is generated.
- The `Skip viewList` parameter lists the views that are selected in the Create Checksum dialog box. At least one view is required to generate a checksum file.
- The `string fileName` parameter identifies the file path that is chosen by user for storing the checksum compressed file. If this field is empty or an invalid path, then a checksum file is not generated.
- The `string& returnStr` parameter is optional. This parameter contains errors that were encountered by the create operation, if any. If the operation completes successfully, the return value is an empty string.

The `createChecksumFile` function returns a boolean value to indicate if the create operation completed successfully. The value is `True` if the operation is successful. If the `string& returnStr` parameter is included, errors are displayed.

#### Example 1 - without progress bar

```
string modName = "myModuleName" // name of the module of your choice
Module modRef = read(modName, false)

int skipNo = 0
Skip viewListFromModule = create

// Enter the Standard View First
```

```

put(viewListFromModule, skipNo++, "Standard view")

//Now other views from module
string theViewName
for theViewName in views(modRef) do {
    // clear the noError
    put(viewListFromModule, skipNo++, theViewName)
}

string locationOfOutput = "C:\\temp\\checksumfile.zip" // or C:\temp

string createErrString
bool isSuccess = createChecksumFile(modRef, viewListFromModule,
locationOfOutput, createErrString)

```

## Example 2 - with progress bar

```

// Use definition of module, skip, and string from Example 1
// Include optional parameter to display progress bar:
DB box = create("Create Checksum ", styleCentred|styleAutoparent|styleThemed)
realize box

bool isSuccess = createChecksumFile(box, modRef, viewListFromModule,
locationOfOutput, createErrString)

```

---

## loadChecksumFile

---

### Declaration

```
bool loadChecksumFile(Module mod, Skip& outViewList, string fileName, string&
returnStr)
```

### Operation

The loadChecksumFile function is preparation for the compareChecksumFile function. The loadChecksumFile function validates the module information and provides a list of the views that are available for the checksum comparison.

The loadChecksumFile declaration includes the following parameters:

- The Module *mod* parameter identifies the module that is associated with the checksum file.
- Skip& *outViewList* is the resulting out parameter. This list contains the views that are present in the checksum package. The user can choose one or more views from this list to run the checksum comparison on.

- The `string fileName` parameter contains the full path and file name of the stored checksum package, which is a compressed file with a `.zip` extension. The value must be a valid path and file.
- The `string& returnStr` parameter is optional. This parameter contains errors that were encountered by the create operation, if any. If the operation completes successfully, the return value is an empty string.

The `loadChecksumFile` function returns a boolean value to indicate if the load file operation completed successfully. The value is `True` if the operation was successful. If any error is found, then the return value is `False`. If the `string& returnStr` parameter is included, errors are displayed.

### Example

```
string modName = "myModuleName" // name of the module of your choice
Module modRef = read(modName, false)
Skip outViewList = create
string checksumFile = "C:\\temp\\checksumfile.zip" //The valid link to existing
checksum zip file.
string loadErrString
bool isSuccess = loadChecksumFile(modRef, outViewList, checksumFile,
loadErrString)
```

---

## compareChecksumFile

---

### Declaration

```
bool compareChecksumFile(DB box, Module mod, Skip viewList, string fileName,
string& returnStr)
```

### Operation

Enables the user to compare the checksum validation record with the related module to identify changes to the text or other attribute values in the selected views.

The `compareChecksumFile` declaration includes the following parameters:

- The `DB box` parameter is optional. If this parameter is included, the progress bar and Checksum Results dialog box are shown while the comparison process is running. The Checksum Results dialog box only shows comparison results. If the comparison process is not successful or completed, the error reasons are returned in the `returnStr` parameter.
- The `Module mod` parameter identifies the module that is associated with the checksum file. This parameter is passed to verify that the module in the Compare Checksum dialog box is the same as the module that is read from the XML content of the checksum package.
- The `Skip skipViewList` parameter provides the names of all the selected views in the Compare Checksum dialog box view list.
- The `String fileName` parameter specifies the full path and file name for checksum package, which is a compressed file with a `.zip` extension. If this parameter is `NULL` then the `checksumPackageFullPath` that is passed with the `loadChecksumFile` perm is used while comparing the views.

- The `string& returnStr` parameter is optional. If this parameter is included, it returns the error strings that indicate why the comparison process did not run or was not completed successfully. If the parameter `DB box` is not included, then the Checksum Results dialog box is not displayed and the comparison results are returned in this `returnStr` parameter.

The `compareChecksumFile` perm returns a boolean value. This value is `True` if the comparison operation completed successfully, even if some comparisons failed. The value is `False` if the comparison operation was not performed.

### Example 1 - without the progress bar

```
string modName = "myModuleName" // name of the module of your choice
Module modRef = read(modName, false)
Skip viewList = create
string checksumFile = "C:\\temp\\checksumfile.zip" //The valid link to existing
checksum zip file.
string loadErrString
bool isLoadSuccess = loadChecksumFile(modRef, viewList, checksumFile,
loadErrString)
if ( isLoadSuccess) {
    string compareResults
    bool isCompareSuccess = compareChecksumFile(modRef, viewList,
checksumFile, compareResults)
    if(isCompareSuccess) {
        print "/n compareResults = /n" compareResults "/n"
    }
}
}
```

### Example 2 - with the progress bar

```
// Picking up after load Success from previous example
// Include optional parameter to display status messages:
if ( isLoadSuccess) {
    string compareResults
    DB box = create("Compare Checksum ",
styleCentred|styleAutoparent|styleThemed)
    realize box
    bool isSuccess = compareChecksumFile(box, modRef, viewList, checksumFile,
compareResults)
}
}
```

---

## Locking

This section defines functions that are used by the manipulation of data locks. They are rarely needed by normal DXL programs.

Most use the data types `LockList` and `Lock`.

**Note:** To obtain a type `Lock` handle, you must use the `for lock in lock list` loop.

---

### Lock properties

---

Properties are defined for use with the `.` (dot) operator and a lock handle, as shown in the following syntax:

`lock.property`

where:

`lock`            Is a variable of type `Lock`  
`property`        Is one of the lock properties

The value of `property` can be one of the following:

String property	Extracts
<code>annotation</code>	Annotation associated with the lock
<code>host</code>	Host name to which the lock is assigned
<code>id</code>	Lock id, which distinguishes shared locks on an item
<code>resourceName</code>	The name of the locked resource For items in the module hierarchy, this is the unqualified name of the item. For locks on the user list, this is <code>User List (Read)</code> or <code>User List (Write)</code> . Separate read and write locks are used, for example, while archiving and restoring the user list.
<code>user</code>	The user account to which the lock is assigned

Boolean property	Extracts
<code>childLocked</code>	Whether the lock is associated with a lock on a descendant of the locked item
<code>removed</code>	Whether the lock has been removed

---

Date property	Extracts
date	Date the lock was created

Integer property	Extracts
lockMode	One of the values: lockShare, lockWrite, or lockRemoved

Item property	Extracts
item	Handle to the locked item, which can be used to access the name of the item
connectionId	An integer value equal to the connection ID associated with the lock

All locks in a lock list are initially in either `lockShare` or `lockWrite` mode. To change them to `lockRemoved`, use the `remove (lock)` function.

## Example

```

Lock lockItem
string username
int connId
LockList lcklist = getLocksInDatabase(true)
for lockItem in lcklist do {
    username = lockItem.user
    connId = lockItem.connectionId
    print "User: " username ", Connection ID: " connId "\n"
}

```

---

## getLocksInDatabase

---

### Declaration

```
LockList getLocksInDatabase([bool allUsers])
```

### Operation

Returns a lock list of type `LockList`, which lists lock information on locks held anywhere in the database except for locks on items that the user currently has open. If `allUsers` is true, the list contains locks held by all users. If `allUsers` is false, or missing, the list contains only locks held by the current user.

You must delete the `LockList` that is returned by this function before you run another function that returns a `LockList`.

### Example

```
LockList llist
l1ist = getLocksInDatabase(true)
```

## getLocksInFolder

### Declaration

```
LockList
getLocksInFolder({Folder|Project} reference,
                 bool recurse
                 [,bool allUsers])
```

### Operation

Returns a lock list of type `LockList`, which lists lock information on locks held anywhere in the folder or project *reference*. If *recurse* is `true`, the list contains all locks on descendants of the folder. If *allUsers* is `true`, the list contains locks held by all users. If *allUsers* is `false`, or missing, the list contains only locks held by the current user.

You must delete the `LockList` that is returned by this function before you run another function that returns a `LockList`.

### Example

```
LockList llist
l1ist = getLocksInFolder(current project,true,true)
```

## getLocksInModule

### Declaration

```
LockList getLocksInModule (ModName_ modRef
                          [,bool allUsers])
```

### Operation

Returns a lock list of type `LockList`, which lists lock information on locks held anywhere in module *modRef*. If *allUsers* is `true`, the list contains locks held by all users. If *allUsers* is `false`, or missing, the list contains only locks held by the current user.

You must delete the `LockList` that is returned by this function before you run another function that returns a `LockList`.

---

## isLocked

---

### Declaration

```
bool isLocked (ModName_ modRef)
```

### Operation

Returns `true` if the specified module is locked by a user; otherwise returns `false`.

Note that this function returns `true` even if a specified module is locked by the current user.

### Example

```
print isLocked(module "New Module")
```

---

## isLockedClosed

---

### Declaration

```
bool isLockedClosed (ModName_ modRef)
```

### Operation

Returns `true` if the current user has an exclusive lock on module *m*, and the module is not currently open. Otherwise, returns `false`.

---

## isLockedByUser

---

### Declaration

```
bool isLockedByUser (Object o)
```

### Operation

Returns `true` if the specified object is locked by the current user when in edit shareable mode. Otherwise, returns `false`.

This function is not equivalent to checking whether the current user can modify the given object.

---

## lock(module)

---

### Declaration

```
string lock (ModName_ modRef
            [,string annotation])
```



## Operation

Places an exclusive lock on module *modRef*, without opening it. Also places share locks on all of its ancestor folders (up to the nearest project). The optional second argument associates an annotation with the lock, which can be retrieved through the annotation property (see “Lock properties,” on page 927). If annotation is a null string or only white space characters, no annotation is stored with the lock.

If the user does not have modify, create, delete, or control access to *modRef*, the call fails.

If the operation succeeds, returns null; otherwise, returns an error message.

## Example

```
string errormess
errormess = lock(module "My module")
if (null errormess)
    print "My module locked.\n"
else
    print errormess "\n"
```

## lock(object)

### Declaration

```
string lock(Object o [, bool& unavailable])
```

### Operation

Locks object *o*. If supplied, the *unavailable* parameter is set to true if the section cannot be locked due to a lock not being available. This is usually because another client has locked the section. If the operation succeeds, returns null; otherwise, returns an error message.

This function only makes sense when *o* is in a module that has been opened shareable.

### Example

```
if (isShare current) {
    string mess = lock current Object
    if (!null mess)
        print "lock failed: " mess "\n"
}
```

## unlock(module)

### Declaration

```
string unlock(ModName_ modRef)
```

### Operation

Removes an exclusive lock placed on module *m* by the same user. Fails if the module is open or this user has no exclusive lock on it. Removes the associated share locks on ancestor folders.

If the operation succeeds, returns null; otherwise, returns an error message.

### Example

```
string errormess
errormess = unlock(module "My module")
if (null errormess)
    print "My module unlocked.\n"
else
    print errormess "\n"
```

## delete(lock list)

### Declaration

```
string delete(LockList list)
```

### Operation

Frees up memory used by the variable *list*. If list is null, this function has no effect.

### Example

```
LockList myList = getLocksInDatabase
delete myList
```

## remove(lock)

### Declaration

```
string remove(Lock lock)
```

### Operation

Attempts to remove *lock* from the database. Any associated locks in the lock list are also removed. Associated locks are locks on descendants of a folder, and associated locks on ancestor folders that are not associated with locks on other descendants.

If the operation succeeds, returns a null string; otherwise, returns an error message.

## shareLock

### Declaration

```
string shareLock({Folder|Project} reference,
                string &lockID
                [,string annotation])
```

## Operation

Places a share lock on the folder or project *reference*, until it is removed by the `remove(lock)` function. It does not lock ancestor folders. It passes back the lock ID in the second argument. The optional third argument associates an annotation with the lock, which can be retrieved through the `annotation` property (see “Lock properties,” on page 927).

If the operation succeeds, returns a null string; otherwise, returns an error message.

## for lock in lock list

### Syntax

```
for lock in list do {
  ...
}
```

where:

<i>lock</i>	Is a variable of type Lock
<i>list</i>	Is a variable of type LockList

### Operation

Assigns the variable *lock* to be each successive lock in *list*.

### Example

```
Lock lockItem
string username
LockList lcklist = getLocksInDatabase(true)
for lockItem in lcklist do {
  username = lockItem.user
  print username "\n"
}
```

## Unlock object functions

### Declaration

```
bool unlockDiscard{All|Section}(Object o)
bool unlockSave{All|Section}(Object o)
```

### Operation

These functions unlock sections. The functions `unlockDiscardAll` and `unlockSaveAll` unlock all sections in the module containing *o*. The functions `unlockDiscardSection` and `unlockSaveSection` unlock the section containing *o*.

The functions either discard changes or save changes before unlocking according to the function name.

If the operation is successful, returns `true`; otherwise, returns `false`.

---

## requestLock

---

### Declaration

```
string requestLock(Module m, Object o, bool exclusive, string msg, bool alert)
string requestLock(Module m, bool exclusive, string msg, bool alert)
string requestLock(Object o, string msg, bool alert)
```

### Operation

The first form places a lock request on the specified module/object in the specified lock mode. If *exclusive* is set to *true*, an exclusive lock will be requested, otherwise a share lock will be requested. *msg* is the message (if any) to be sent.

The second form requests a lock on the module itself.

The third form requests a lock on the section containing the specified object.

All return errors on failure.

---

## HTML functions

This section defines functions that create HTML to represent a Rational DOORS object attribute, and set an attribute value based on HTML.

---

## htmlText

---

### Declaration

```
string htmlText(Buffer &htmlOutput,
               Column c,
               Object o,
               bool showURL,
               bool newWin,
               string preLink,
               string postLink)

string htmlText(Buffer &htmlOutput,
               attrRef,
               bool showURL,
               bool newWin,
               string preLink,
               string postLink)
```

where *attrRef* is in one of the following formats:

```
(Object o).(string attrName)
```

```
(Module m).(string attrName)
```

```
(Link l).(string attrName)
```

## Operation

The first form fills the buffer *htmlOutput* with a fragment of HTML representing the object *o* in column *c*. The second form does the same for the given object attribute.

The argument *showURL* controls whether URLs in the text are shown as hyperlinks. The argument *newWin* controls whether the hyperlinks should open a new browser window.

If *showURL* is true, the strings *preLink* and *postLink* contain text that appears before the hyperlink and after the hyperlink respectively.

If the call succeeds, returns a null string; otherwise, returns an error message.

## Example

```
Buffer b = create
Object o = current Object
htmlText(b, o."Object Text", true, false, "", "")
print b"\n"
```

## setAttrFromHTML

### Declaration

```
string setAttrFromHTML(Buffer &html,
                       attrRef,
```

where *attrRef* is in one of the following formats:

```
(Object o).(string attrName)
```

```
(Module m).(string attrName)
```

```
(Link l).(string attrName)
```

### Operation

Sets the value of the specified attribute based on the HTML in the buffer.

If the call succeeds, returns a null string; otherwise, returns an error message.

### Example

```
Buffer b = create
Object o = current Object
b = "hello <b>world</b>"
setAttrFromHTML(b, o."Object Text")
```

---

## HTTP Server

This section defines functions for making HTTP requests to a URL.

Sample files are included in the Rational DOORS client installation. The sample file `hierarchy.dxl` shows how to use the OSLC DXL service to obtain information about module hierarchy. The sample file `sample_get.dxl` demonstrates other HTTP Server functions. The default location of the sample files is `C:\Program Files\IBM\Rational\DOORS\9.version\lib\dxl\example\oslc`. The path and version number might vary in your installation.

---

### HttpRequest

---

#### Declaration

```
HttpResponse HttpRequest(HttpVerb verb, string url, HttpBody body, HttpHeaders header)
```

#### Operation

This function makes the HTTP request to the provided URL. If the URL is to a server that is configured for Open Services for Lifecycle Collaboration (OSLC) the request is authenticated with OAuth, and automatically includes the configured OSLC version in the request header, as OSLC-CORE-VERSION. To determine if the server is configured for OSLC, see the Database Properties > Collaboration tab in the Rational DOORS client. The body and header parameters are optional.

#### Example

This example demonstrates access to a public URL with no OAuth authentication. The use of `HttpHeader` is demonstrated, but is optional and can be null. After the request is sent, a response is returned. The example reads the HTML code from the response body and displays it. Optional cleaning of the memory is also demonstrated.

```
HttpHeader h = create
string k = "Accept"
string v = "**/*"

if (header != null)
{
    add(h, k, v)
}

HttpResponse resp = HttpRequest(HttpGet, "https://www.google.com", null, h)

if (resp != null && resp.isOk)
{
    HttpBody b = resp.body
    Buffer buf = b.value
    ack "Request succesfull\n"
    ack stringOf(buf)
    delete buf
}
}
```

```

else
{
    ack "Request failed"
}
delete h
delete resp

```

---

## HttpRequest(timeout)

---

### Declaration

```

HttpResponse HttpRequest(HttpVerb verb, string url, HttpBody body, HttpHeaders
header, int timeout)

```

### Operation

This function is the same as **HttpResponse HttpRequest(HttpVerb, string, HttpBody, HttpHeaders)**, but it includes an additional timeout argument. The request is performed as usual but with the specified timeout instead of the default one. The timeout argument is in seconds.

---

## HttpRequest(error message)

---

### Declaration

```

string HttpRequest(HttpVerb, string, HttpBody, HttpHeaders, HttpResponse&)

```

### Operation

This function is the same as **HttpResponse HttpRequest(HttpVerb, string, HttpBody, HttpHeaders)**, but it returns an error message in case of failure.

---

## HttpRequest(timeout and error message)

---

### Declaration

```

string HttpRequest(HttpVerb, string, HttpBody, HttpHeaders, int, HttpResponse&)

```

### Operation

This function is the same as **HttpResponse HttpRequest(HttpVerb verb, string url, HttpBody body, HttpHeaders header, int timeout)**, but it returns an error message in case of failure.

---

## HttpVerb

---

The `HttpVerb` is an enumeration that represents the type of HTTP request:

`HttpDelete`

`HttpGet`

`HttpHead`

`HttpPut`

`HttpPost`



---

## HttpResponse

---

The HttpResponse object represents the response to an HTTP request.

### Properties

Property	Returns
<code>HTTPHeader header()</code>	An HttpHeader object that stores a map of key-value string pairs.
<code>HttpBody body()</code>	Any data returned by the HTTP request in its body as an HttpBody object.
<code>int code()</code>	The HTTP response code.
<code>bool isOk()</code>	True for a successful HTTP request; for example, if the return code is 200 or 201.

### Operations

Operation	Description
<code>void delete(HttpResponse&amp;)</code>	Call to delete the HttpResponse object that is returned by HttpRequest. This operation is not mandatory.

---

## HTTPHeader

---

The HttpHeader object represents a collection of header key-value of a HTTP request or response.

### Operations

Operation	Description
<code>string get(HttpHeader header, string key)</code>	Returns a header pair value by its key.
<code>void add(HttpHeader&amp; header, string key, string value)</code>	Add a header key-value pair to header.
<code>void add(HttpHeader&amp; header, HttpHeaderEntry entry)</code>	Add a header key-value pair to header from HttpHeaderEntry.
<code>HTTPHeader create()</code>	Call to create a HttpHeader object.
<code>void delete(HttpHeader&amp;)</code>	Call to delete the HttpHeader object returned by create, this isn't mandatory.

---

## Iterators

Iterator	Description
<code>for HttpHeaderEntry in HttpHeader do</code>	Returns all <code>HttpHeaderEntry</code> in the header. The order is undetermined.

## HttpHeaderEntry

`HttpHeaderEntry` represents a header key-value pair.

### Properties

Property	Returns
<code>string value()</code>	The <code>HttpHeaderEntry</code> value.
<code>string key()</code>	The <code>HttpHeaderEntry</code> key.

### Operations

Operation	Description
<code>void delete(HttpHeaderEntry&amp;)</code>	Call to delete the <code>HttpHeaderEntry</code> object that is returned by <code>create</code> . This operation is not mandatory.
<code>HttpHeaderEntry create()</code>	Call to create a <code>HttpHeaderEntry</code> object.
<code>void setValue(HttpHeaderEntry&amp; entry, string value)</code>	Set the <code>HttpHeaderEntry</code> value.
<code>void setKey(HttpHeaderEntry&amp; entry, string value)</code>	Set the <code>HttpHeaderEntry</code> key.

## HttpBody

The `HttpBody` object represents the body (data part) of an HTTP request or response.

## Properties

Property	Returns
<code>Buffer value()</code>	The content of the body.
<code>int size()</code>	Returns the number of character in the body.

## Operations

Operation	Description
<code>void setValue(HttpBody&amp; body, Buffer value)</code>	Set the content of the body.
<code>HttpBody create()</code>	Call to create a HttpBody object.
<code>void delete(HttpBody&amp;)</code>	Call to delete the HttpBody object that is returned by create. This operation is not mandatory.

# Asynchronous HTTP requests

These functions are used to make HTTP requests asynchronously so that the main Rational DOORS process is not blocked. With these functions, the DXL user interface is still be responsive while an HTTP request is in progress.

## Future HttpRequest

### Declaration

```
Future HttpRequest(HttpVerb verb, string url, HttpBody b, HttpHeaders h)
```

Where Future is an object that contains a value that will be delivered in the future.

### Operation

This function starts an HTTP request but instead of waiting for a response, it immediately returns a Future object. The Future object can be checked for readiness later. The HTTP response can be fetched from the Future object when it is ready.

Property	Description
<code>bool isReady(Future f)</code>	Returns true if the Future is delivered.
<code>int getFullfilledTime(Future f)</code>	Returns the timestamp for the Future's delivery time.

Operation	Description
<code>HttpResponse</code> <code>getValueHttpResponse(Future f)</code>	Returns 'HttpResponse' value inside the Future. The Future needs to be ready before this call is made.

Helper operations for using the asynchronous HTTP request perm in layout DXL columns:

Operation	Description
<code>void refresh(Future f, Object o, Column c, int elapsed)</code>	Re-executes the layout DXL for a cell after the Future is fulfilled. After the Future is delivered, this operation: <ul style="list-style-type: none"> <li>• Invalidates the displayable object cache for the cell (Object o, Column c).</li> <li>• After 'elapsed' seconds, refreshes everything in the current view set. This causes the layout DXL execution, because the cell does not have a displayable object cache.</li> </ul>
<code>Future getData(Object o, string key)</code>	Retrieves a Future.
<code>void setData(Object o, string key, Future f)</code>	Puts a Future inside object's "client data". This keeps the Future for successive layout DXL executions.
<code>void removeData(Object o, string key)</code>	Removes a Future from object's "client data".

### Dialog box example:

```
// Async http request example with dxl timer
DB box
DBE htmlViewElem
DBE timerElem

string url = "http://en.m.wikipedia.org/wiki/DOORS"

// Make an async request put the future in object client data
Future f = HttpRequest(HttpGet, url, null, null)

// Will be called in every second,
// when the response is delivered it will stop the timer.
void onTimer(DBE)
```

```

{
    if (isReady(f))
    {
        HttpResponse r = getValueHttpResponse(f)
        set(htmlViewElem, r.body.value)
        stopTimer(timerElem)
    }
    else
    {
        Buffer b = create
        b = "<h3>LOADING URL: " url "</h3>"
        set(htmlViewElem, b)
        delete b
    }
}

// Prepare a dialog with a timer
box = create "Async HttpRequest Example!"
htmlViewElem = htmlEdit(box, "", 600, 400)
timerElem = timer(box, 1, onTimer, "check response timer!")
show box

```

### Layout DXL example:

// This is a layout DXL example. For each objects in the module, it fetches the 'url' and displays its status code.

// Usage: Add a column via "Edit -> Columns -> New... -> Layout DXL -> Browse -> New -> (Paste this)"

```

Column c = currentColumn
string url = "http://www.ibm.com/robots.txt"

void startRequest(string url)
{
    Future f = HttpRequest(HttpGet, url, null, null)
    setData(obj, "KEY_PREF_" url, f)
}

```

```

        refresh(f, obj, c, 5 /*seconds timeout*/)
        display("Started request:\n\t" url "\n")
    }

    Future f = getData(obj, "KEY_PREF_" url)
    if (null f) // No request made yet
    {
        startRequest(url)
    }
    else if (isReady(f))
    {
        if (intOf today - getFullfilledTime(f) > 30) // Ready but expired (> 30
seconds)
        {
            removeData(obj, "KEY_PREF_" url)
            startRequest(url)
        }
        else // Ready and fresh response!
        {
            HttpResponse r = getValueHttpResponse(f)
            display("Response received with status code: " r.code "\n")
        }
    }
    else // Waiting for a response!
    {
        display("Started request:\n\t" url "\n")
    }
}

```

---

## OSLC DXL Services

OSLC DXL Services are DXL scripts that can be run by making an Open Services for Lifecycle Collaboration (OSLC) request to an instance of Rational DOORS Web Access. A service must be added to the DOORS database before it can be run. DXL functions are available to add, remove, and return information about DXL services. For more information and examples, see the help topic: OSLC DXL services for Rational DOORS.

---

### OSLCDXLService properties

---

Properties are defined for use with the `.` (dot) operator and a `OSLCDXLService` handle, as shown in the following syntax:

*variable.property*

where:

<i>variable</i>	Is a variable of type <i>OSLCDXLService</i>
<i>property</i>	Is one of the <i>OSLCDXLService</i> properties

The following table lists the `OSLCDXLService` properties and the information that they extract or specify.

For further details on specifying information, see the `setDxlServiceResult` function.

## Properties

Property	Extracts
name	The name of the service, as displayed by OSLC service discovery.
description	The explanation of what the service does. This can be returned by using the GET function on the service.
dxlString	Either a fragment of DXL that can be run or a collection of functions, one of which can be called by running "functionName".
functionName	The name of a function (in dxlString) to run. If this is NULL, then dxlString will be treated as runnable DXL.

## Iterators

Iterator	Description
for OSLCDXLService in database do	Loop that iterates over available DXL services.

---

## setDxlServiceResult

---

### Declaration

```
void setDxlServiceResult(string result)
```

### Operation

Sets the result string that is returned as a result of the service that is being run.

### Example

For more information and an example, see the help topic: OSLC DXL services for Rational DOORS.

---

## addOrUpdateOSLCDXLService

---

### Declaration

```
string addOrUpdateOSLCDXLService(string name, string description, string  
dxlString, string functionName)
```

### Operation

Adds a new service to the list of configured DXL services or updates an existing one.

### Example

For more information and an example, see the help topic: OSLC DXL services for Rational DOORS.



---

## removeOSLCDXLService(string key)

---

### Declaration

```
string removeOSLCDXLService(string key)
```

### Operation

Removes a service from the configuration. Finds the service by its key (that is, name).

---

## removeOSLCDXLService(OSLCDXLService service)

---

### Declaration

```
string removeOSLCDXLService(OSLCDXLService service)
```

### Operation

Removes a service object from the configuration.

---

# Broadcast Messaging

---

---

## sendBroadcastMessage

---

### Declaration

```
string sendBroadcastMessage(string msg)
```

### Operation

Sends a message to the database server for broadcasting to all connected clients. Returns an error string if broadcasting fails, otherwise returns null. The executing user must have the Manage Database privilege.

### Example

```
if (null sendBroadcastMessage("Please save your work and logout immediately.")){  
    ack "Message sent"  
}
```

---

## Converting a symbol character to Unicode

---

### symbolToUnicode

---

#### Declaration

```
char symbolToUnicode(char symbolChar, bool convertAllSymbols)
```

#### Operation

Converts a symbol character to its Unicode equivalent. If *convertAllSymbols* is false, only symbols with the Times New Roman font equivalents are converted. This function returns a unicode character, or `charIn` if there is no equivalent character.

---

# Timer

---

---

## timer

---

### Declaration

```
DBE timer(DB parent, [int/real] timer_duration_in_seconds) , void(DBE)
callbackFn, string timer_name)
```

### Operation

Creates a timer element that executes the callback function every 'n' seconds.

### Example

The following example creates a timer with a two-second interval and callback cb that prints a message.

```
void cb(DBE x){
    print "timer event,"
}
DBE dbeTime = timer(dbParent, 2, cb, "")
```

---

## stopTimer

---

### Declaration:

```
bool stopTimer(DBE timer)
```

### Operation

Stops the execution of a specific timer. Returns true if the timer was running and is now stopped.

### Example

This example stops timer.

```
stopTimer(dbeTimer)
```

---

## startTimer

---

### Declaration

```
bool startTimer(DBE timer)
```

### Operation

Restarts the execution of a specific timer. Returns true if the timer was stopped and is now restarted.

## Example

This example restarts the timer.

```
startTimer(dbeTimer)
```

---

## isTimer

---

### Declaration

```
bool isTimer(int id)
```

### Operation

Returns TRUE if `id` is a valid action index and it is a timer.

---

## getTimerName

---

### Declaration

```
string getTimerName(int id)
```

### Operation

Returns a string containing the name of the timer (or NULL if not a timer).

---

## getTimerInterval

---

### Declaration

```
int getTimerInterval(int id)
```

### Operation

Returns the number of seconds between each execution of the timer.

---

## getTimerID

---

### Declaration

```
int getTimerID(DBE t)
```

### Operation

Returns the timer `t` ID or `-1` if `t` is not a timer.

## Example

The following example prints "test".

```
void cb(DB x) {}
DB db = create("test")
DBE t = timer(db, 1, cb, "test")
realize db
int id = getTimerID(t)
print getTimerName id
```

---

## getTimerRunning

---

### Declaration

```
bool getTimerRunning(int id)
```

### Operation

Returns TRUE if `id` is a timer and it is running.

### Example

The following example prints all running timers.

```
int i
for i in 0 : 999 do
{
    string s = getTimerName(i)
    if (!null s)
    {
        int    d = getTimerInterval(i)
        bool   r = getTimerRunning (i)
        print "Timer " i " is " (r ? "" : "not ") "running with interval " d "\n"
    }
}
```



## Chapter 37

# Character codes and their meanings

The following table lists the characters for ASCII codes 0-127. For ASCII codes 128 and higher, Rational DOORS uses Latin-1 encoding. The character sets for Latin-1 differ between platforms.

**Table 1: ASCII codes 0-127**

Decimal Value	Hex Value	Control Character	ASCII Symbol	Meaning
0	00	Ctrl-@	NUL	null
1	01	Ctrl-A	SOH	start of heading
2	02	Ctrl-B	STX	start of text
3	03	Ctrl-C	ETX	end of text
4	04	Ctrl-D	EOT	end of transmission
5	05	Ctrl-E	ENQ	enquiry
6	06	Ctrl-F	ACK	acknowledge
7	07	Ctrl-G	BEL	bell
8	08	Ctrl-H	BS	backspace
9	09	Ctrl-I	HT	horizontal tab
10	0A	Ctrl-J	LF	new line
11	0B	Ctrl-K	VT	vertical tab
12	0C	Ctrl-L	FF	form feed
13	0D	Ctrl-M	CR	carriage return
14	0E	Ctrl-N	SO	shift out
15	0F	Ctrl-O	SI	shift in
16	10	Ctrl-P	DLE	data link escape
17	11	Ctrl-Q	DC1	device control 1
18	12	Ctrl-R	DC2	device control 2
19	13	Ctrl-S	DC3	device control 3

**Table 1: ASCII codes 0-127**

Decimal Value	Hex Value	Control Character	ASCII Symbol	Meaning
20	14	Ctrl-T	DC4	device control 4
21	15	Ctrl-U	NAK	negative acknowledge
22	16	Ctrl-V	SYN	synchronous idle
23	17	Ctrl-W	ETB	end of transmission block
24	18	Ctrl-X	CAN	cancel
25	19	Ctrl-Y	EM	end of medium
26	1A	Ctrl-Z	SUB	substitute
27	1B	Ctrl-[	ESC	escape
28	1C	Ctrl-\	FS	file separator
29	1D	Ctrl-]	GS	group separator
30	1E	Ctrl-^	RS	record separator
31	1F	Ctrl- <u>_</u>	US	unit separator
32	20		SP	digit select
33	21		!	exclamation point
34	22		"	double quotation mark
35	23		#	pound sign, number sign
36	24		\$	dollar sign
37	25		%	percent sign
38	26		&	ampersand
39	27		'	apostrophe
40	28		(	left parenthesis
41	29		)	right parenthesis
42	2A		*	asterisk
43	2B		+	addition sign
44	2C		,	comma



**Table 1: ASCII codes 0-127**

Decimal Value	Hex Value	Control Character	ASCII Symbol	Meaning
45	2D		-	subtraction sign
46	2E		.	period
47	2F		/	right slash
48	30		0	
49	31		1	
50	32		2	
51	33		3	
52	34		4	
53	35		5	
54	36		6	
55	37		7	
56	38		8	
57	39		9	
58	3A		:	colon
59	3B		;	semicolon
60	3C		<	less than
61	3D		=	equal
62	3E		>	greater than
63	3F		?	question mark
64	40		@	at sign
65	41		A	
66	42		B	
67	43		C	
68	44		D	
69	45		E	

**Table 1: ASCII codes 0-127**

Decimal Value	Hex Value	Control Character	ASCII Symbol	Meaning
70	46		F	
71	47		G	
72	48		H	
73	49		I	
74	4A		J	
75	4B		K	
76	4C		L	
77	4D		M	
78	4E		N	
79	4F		O	
80	50		P	
81	51		Q	
82	52		R	
83	53		S	
84	54		T	
85	55		U	
86	56		V	
87	57		W	
88	58		X	
89	59		Y	
90	5A		Z	
91	5B		[	left bracket
92	5C		\	left slash, backslash
93	5D		]	right bracket
94	5E		^	hat, circumflex, caret

**Table 1: ASCII codes 0-127**

Decimal Value	Hex Value	Control Character	ASCII Symbol	Meaning
95	5F		_	underscore
96	60		`	grave accent
97	61		a	
98	62		b	
99	63		c	
100	64		d	
101	65		e	
102	66		f	
103	67		g	
104	68		h	
105	69		i	
106	6A		j	
107	6B		k	
108	6C		l	
109	6D		m	
110	6E		n	
111	6F		o	
112	70		p	
113	71		q	
114	72		r	
115	73		s	
116	74		t	
117	75		u	
118	76		v	
119	77		w	

**Table 1: ASCII codes 0-127**

<b>Decimal Value</b>	<b>Hex Value</b>	<b>Control Character</b>	<b>ASCII Symbol</b>	<b>Meaning</b>
120	78		x	
121	79		y	
122	7A		z	
123	7B		{	left brace
124	7C			logical or, vertical bar
125	7D		}	right brace
126	7E		~	similar, tilde
127	7F		DEL	delete

## Chapter 38

# Notices

This information was developed for products and services offered in the U.S.A. IBM may not offer the products, services, or features discussed in this document in other countries. Consult your local IBM representative for information on the products and services currently available in your area. Any reference to an IBM product, program, or service is not intended to state or imply that only that IBM product, program, or service may be used. Any functionally equivalent product, program, or service that does not infringe any IBM intellectual property right may be used instead. However, it is the user's responsibility to evaluate and verify the operation of any non-IBM product, program, or service.

IBM may have patents or pending patent applications covering subject matter described in this document. The furnishing of this document does not grant you any license to these patents. You can send written license inquiries to:

IBM Director of Licensing  
IBM Corporation  
North Castle Drive  
Armonk, NY 10504-1785  
U.S.A.

For license inquiries regarding double-byte character set (DBCS) information, contact the IBM Intellectual Property Department in your country or send written inquiries to:

Intellectual Property Licensing  
Legal and Intellectual Property Law  
IBM Japan, Ltd.  
19-21, Nihonbashi-Hakozakicho, Chuo-ku  
Tokyo 103-8510, Japan

**The following paragraph does not apply to the United Kingdom or any other country where such provisions are inconsistent with local law:** INTERNATIONAL BUSINESS MACHINES CORPORATION PROVIDES THIS PUBLICATION "AS IS" WITHOUT WARRANTY OF ANY KIND, EITHER EXPRESS OR IMPLIED, INCLUDING, BUT NOT LIMITED TO, THE IMPLIED WARRANTIES OF NON-INFRINGEMENT, MERCHANTABILITY OR FITNESS FOR A PARTICULAR PURPOSE. Some states do not allow disclaimer of express or implied warranties in certain transactions. Therefore, this statement may not apply to you.

This information could include technical inaccuracies or typographical errors. Changes are periodically made to the information herein; these changes will be incorporated in new editions of the publication. IBM may make improvements and/or changes in the product(s) and/or the program(s) described in this publication at any time without notice.

Any references in this information to non-IBM websites are provided for convenience only and do not in any manner serve as an endorsement of those websites. The materials at those websites are not part of the materials for this IBM product and use of those websites is at your own risk.

IBM may use or distribute any of the information you supply in any way it believes appropriate without incurring any obligation to you.

Licensees of this program who wish to have information about it for the purpose of enabling: (i) the exchange of information between independently created programs and other programs (including this one) and (ii) the mutual use of the information which has been exchanged, should contact:

Intellectual Property Dept. for Rational Software  
IBM Corporation  
5 Technology Park Drive  
Westford, Massachusetts 01886  
U.S.A.

Such information may be available, subject to appropriate terms and conditions, including in some cases, payment of a fee.

The licensed program described in this document and all licensed material available for it are provided by IBM under terms of the IBM Customer Agreement, IBM International Program License Agreement or any equivalent agreement between us.

Any performance data contained herein was determined in a controlled environment. Therefore, the results obtained in other operating environments may vary significantly. Some measurements may have been made on development-level systems and there is no guarantee that these measurements will be the same on generally available systems. Furthermore, some measurements may have been estimated through extrapolation. Actual results may vary. Users of this document should verify the applicable data for their specific environment.

Information concerning non-IBM products was obtained from the suppliers of those products, their published announcements or other publicly available sources. IBM has not tested those products and cannot confirm the accuracy of performance, compatibility or any other claims related to non-IBM products. Questions on the capabilities of non-IBM products should be addressed to the suppliers of those products.

All statements regarding IBM's future direction or intent are subject to change or withdrawal without notice, and represent goals and objectives only.

This information contains examples of data and reports used in daily business operations. To illustrate them as completely as possible, the examples include the names of individuals, companies, brands, and products. All of these names are fictitious and any similarity to the names and addresses used by an actual business enterprise is entirely coincidental.

If you are viewing this information softcopy, the photographs and color illustrations may not appear.

## Trademarks

IBM, the IBM logo, and [ibm.com](http://www.ibm.com) are trademarks or registered trademarks of International Business Machines Corp., registered in many jurisdictions worldwide. Other product and service names might be trademarks of IBM or other companies. A current list of IBM trademarks is available on the web at [www.ibm.com/legal/copytrade.html](http://www.ibm.com/legal/copytrade.html).

Java and all Java-based trademarks and logos are trademarks or registered trademarks of Oracle and/or its affiliates.

Linux is a registered trademark of Linus Torvalds in the United States, other countries, or both.

Microsoft and Windows are trademarks of Microsoft Corporation in the United States, other countries, or both.

PostScript is either a registered trademark or trademark of Adobe Systems Incorporated in the United States, and/or other countries.

UNIX is a registered trademark of The Open Group in the United States and other countries.

Other company, product or service names may be trademarks or service marks of others.

# Index

## Symbols

:: operator 17  
 ::do(AccessRec&, SignatureInfo, void) 353  
 ::do(AccessRec&, SignatureInfoSpecifier\_\_\_, void) 353  
 ::do(SignatureEntry&, SignatureInfo, void) 357

## A

accept(IPC) 189  
 accept(object) 645  
 acceptPartition 712  
 acceptReport 712  
 Access status 468  
 accessed(date) 182  
 AccessRec get(SignatureInfo, string name, string& error) 354  
 acknowledge 484  
 activateURL function 26  
 active(element) 501  
 Actual colors 591  
 addAcceleratorKey 487  
 addAttribute 706  
 addAwayAttribute 706  
 addAwayLinkModule 705  
 addAwayLinkset 707  
 addAwayModule 705  
 addAwayView 707  
 addBaselines(BaselineSet) 326  
 addComment(Discussions) 897  
 addFilter 645  
 addGroup 245  
 addGroup (Discussions access controls) 903  
 addLinkModule 704  
 addLinkModuleDescriptor 404  
 addLinkset 707  
 addMember 247  
 addMenu 500  
 addModule 704  
 addModule(BaselineSetDefinition) 315  
 addNotifyUser 224  
 addOrUpdateOSLCDXLService 946  
 addProjectEntry(ProblemItem) 890  
 addRecentlyOpenModule(ModuleVersion) 344  
 addRecentlyOpenModule(string) 345  
 addToolTip 576  
 addUser 246  
 addUser (Discussions access controls) 903  
 addView 707  
 all(module) 372  
 allAttributesReadable(SignatureEntry) 360  
 allowsAccess 709  
 alternative 860, 866  
 Alternative Addins Location 625  
 alternatives 860  
 alternativeWord 876  
 anagram 878  
 ancestors(show/hide) 652  
 ancestors(state) 652  
 annotation(BaselineSet) 324  
 append 207  
 Append operator 163  
 append(open file) 135  
 appendCell 818  
 appendColumn(table) 818  
 appendRow 819  
 appendSignatureEntry(SignatureInfo si, string label, string comment) 356  
 Application of regular expressions 159  
 apply 555  
 apply(arrows) 557  
 apply(partition definition) 711  
 applyFiltering 653  
 applyingFiltering 653  
 applyTextFormattingToParagraph 845  
 Archive  
   and restore 910  
   properties 910  
 archive(modules and projects) 912  
 archive(user list) 913  
 archiveFiles 913  
 Arithmetic operators (int) 119  
 Arithmetic operators (real) 122  
 Arrays 172  
 ascending 659  
 Assignment (buffer) 163  
 Assignment (date) 148  
 Assignment (enumerated option) 436  
 Assignment (from attribute) 428  
 Assignment (int) 120  
 Assignment (real) 123  
 Assignment (rich text) 836  
 Assignment (to attribute) 429  
 Asynchronous HTTP requests 941  
 Attachment placement 599

- attrdef(trigger) 781
- attrDXLName 464
- Attribute definitions
  - access controls 448
  - example program 446
  - introduction 437
  - properties 41, 49, 437
- Attribute types
  - access controls 456
  - manipulation 457
  - properties 450
  - values 50, 450
- Attribute values
  - access controls 434
  - extraction 427
- attribute(in column) 686
- attribute(trigger) 781
- attribute(value) 644
- attributeDXL 548
- attributeValue 201, 442
- attrName 687
- Auto-declare 8
- autoIndent 302
- Automation
  - interface 767
- Automation client 762

## B

- background 560
- backgroundColor(get) 687
- backgroundColor(set) 688
- backSlasher 129
- Backtrace 908
- baseline 305
- baseline(history session) 337
- baseline(ModuleVersion) 311
- baselineExists 305
- baselineExists(ModuleVersion) 311
- baselineIndex(discussions) 900
- baselineInfo(current Module) 311
- Baselines,example program 309
- baselineSet(ModuleVersion) 327
- baseWin 488
- batchMode function 26
- below(element) 594
- beside 594
- bitmap 569
- block 488
- bool pageSignaturePage 810
- Boolean operators 116
- box 564
- Break statement 22
- bringToFront 304
- Browsing the DXL library 5
- Buffer comparison 164
- Buffers and regular expressions 170
- busy 488
- button 556
- button(arrows) 557
- Buttons 554

## C

- Callstack 908
- canceled(IntegrityResultsData) 885
- cancelled(IntegrityResultsData) 885
- canControl(attribute type) 456
- canControl(attribute) 434
- canControl(item) 266
- canControl(module) 289
- canControl(object) 370
- canControl(view) 674
- canControlDef 448
- canControlVal 449
- canCreate(attribute type) 456
- canCreate(attribute) 434
- canCreate(item) 266
- canCreate(module) 289
- canCreate(object) 370
- canCreate(view) 674
- canCreateAttrDefs 449
- canCreateAttrTypes 457
- canCreateDef 448
- canCreateServerArchive 921
- canCreateVal 448
- canDelete 382
- canDelete(attribute type) 457
- canDelete(attribute) 435
- canDelete(external link) 414
- canDelete(item) 267
- canDelete(link) 395
- canDelete(module) 290
- canDelete(object) 370
- canDelete(view) 675
- canDeleteDef 449
- canDeleteVal 449
- canEveryoneModifyDiscussions 902
- canLock(object) 371
- canModify(attribute type) 457



- canModify(attribute) 435
- canModify(item) 266
- canModify(module) 290
- canModify(object) 370
- canModify(view) 674
- canModifyDiscussions 902
- canOpenFile 135
- canRead(attribute type) 457
- canRead(attribute) 430
- canRead(item) 266
- canRead(module) 295
- canRead(object) 370
- canRead(view) 674
- canReadServerArchiveFile 921
- canRestoreServerArchive 921
- canUnlock(object) 371
- canUseServerArchive 922
- canvas 559
- canWrite(attribute) 430
- canWrite(module) 295
- canWrite(view) 675
- canWriteServerArchiveFile 922
- Casts 19
- cell 815
- centered 489
- change(view definition) 678
- changed(date) 182
- changePasswordDialog 225
- changePicture 751
- Character constants 13
- Characters
  - ASCII codes 953
  - classes 117
  - codes and their meanings 953
  - extracting from a buffer 165
  - extracting from a string 117
  - set constants 848
  - set identification 848
- characterSet 850
- charOf 118
- charsetDefault 849
- checkBox 530
- checkConnect 251
- checkDatabaseIntegrity(Folder&, IntegrityResultsData&) 884
- checkDN 251
- checkDXL function 25
- checkFolderIntegrity(Folder, IntegrityResultsData&, bool) 885
- checkItem(IntegrityProblem) 891
- Checksum validation 923
- choice 538
- Choice dialog box elements 538
- cistrcmp 127
- clear(oleAutoArgs) 766
- clearDefaultViewForModule 667
- clearDefaultViewForUser 667
- clearInvalidInheritanceOf 672
- clearSearchObject 388
- clearToolTips 577
- client 188
- Clipboard general functions 390
- clipClear 268
- clipCopy 267
- clipCut 267
- clipLastOp 269
- clipPaste 268
- clipUndo 269
- close 555
- close(baselineSet) 325
- close(configuration area stream) 145
- close(Dictionary) 876
- close(module) 298
- close(partition file) 711
- close(stream) 136
- closeDiscussion 898
- closeFolder 282
- closeProject 286
- codepageName 206
- color 561
- Color schemes 193
- color(get) 687
- color(set) 687
- Colors 588
- column 686
- Column alignment constants 686
- column(value) 644
- Columns 686
- combine 166
- comment (Trigger) 901
- Comment variable (Discussions) 895
- Comment(Discussion Types) 893
- Comments 10
- Common element operations 499
- compareChecksumFile 925
- Complex canvases 572
- Compound
  - filters 654
  - sort 660
  - statements 20

- Concatenation (attribute base type) 453
- Concatenation (attribute definition) 440
- Concatenation (attribute) 428
- Concatenation (base types) 113
- Concatenation (buffers) 164
- Concatenation (dates) 147
- Concatenation (history type) 332
- Conditional statements 20
- confAppend 144
- confCopyFile 144
- confDeleteDirectory 143
- confDeleteFile 144
- confDownloadFile 147
- confFileExists 145
- Configuration file access 141
- confirm 485
- confirmPasswordDialog 226
- confMkdir 142
- confRead 143
- confRenameFile 144
- confUploadFile 146
- confWrite 143
- Constants
  - and general functions 857
  - dictionary 858
  - icons 482
  - language 857
  - of type int 751
  - spell check modes 858
  - table 813
  - trigger 774
  - type bool 116
- Constants (history type) 331
- Constants for codepages 205
- Constrained placement
  - basics 597
  - introduction 597
- contains 166, 646
- containsOle 743
- contents 645
- Continue statement 23
- Controlling
  - Electronic Signature ACL 351
  - Rational DOORS from applications that support automation 767
- Convert to real 123
- convertFolderToProject 281
- convertFromCodepage 208
- convertProjectToFolder 280
- convertToCodepage 208
- convertToFolder(ProblemItem) 890
- copy(module) 300
- copy(partition definition) 702
- copyFile 137
- copyPassword 226, 236
- copyPictureObject 751
- copyToClipboard 190
- cos(Real Angle) 125
- create 811
  - create(array) 172
  - create(attribute definition) 440
  - create(attribute type) 458
  - create(Baseline Set) 323
  - create(baseline) 306
  - create(BaselineSetDefinition) 313
  - create(buffer) 167
  - create(descriptive module) 298, 342
  - create(dialog box) 489
  - create(Discussion) 897
  - create(external link) 414
  - create(folder) 281
  - create(formal module) 297
  - create(link module) 298
  - create(linkset) 410
  - create(object) 380
  - create(oleAutoArgs) 765
  - create(partition definition) 702
  - create(Project) 285
  - create(skip list) 154
  - create(status handle) 181
  - create(view definition) 677
- createButtonBar 490, 635
- createChecksumFile 923
- createCombo 490, 640
- createDropCallback 788
- createEditableCombo 588
- createItem 490, 635
- createMenu 633
- createPasswordDialog 224
- createPopup 640
- createPrivate 677
- createPublic 677
- createString(skip list) 154
- Creating a user account example program 228
- Current folder, setting 279
- Current module, setting 290
- Current object 376
- Current object, setting 376

Current page setup, setting 808  
 Current project, setting 282  
 current(folder) 279  
 current(module) 291  
 current(object) 377  
 current(page setup) 808  
 current(project) 283  
 current(trigger) 781  
 currentANSIcodepage 206  
 currentColumn(get) 694  
 currentDirectory 137  
 currentView 663  
 Customizing Rational DOORS 193  
 cutRichText 837

## D

data(for ModuleVersion) 310  
 Database Explorer 195  
 Database Integrity Checker 883  
 Database Integrity Perms 884  
 Database Integrity Types 883  
 Database Properties 210  
 Database properties 213  
 date 151  
 date(DBE date\_dbe) 532  
 dateAndTime 152  
 dateOf 150  
 dateOf(BaselineSet) 325  
 dateOnly 152  
 Dates 147  
 Dates, comparison 148  
 DBE resizing 606  
 DdcMode constants 726  
 Declarations 15  
 Declarators 15  
 decodeResourceURL 425  
 decodeURL 418  
 Default link module 410  
 defaultTableAttribute 827  
 delete 811  
 delete(array) 173  
 delete(attribute definition) 441  
 delete(attribute type) 459  
 delete(Baseline) 312  
 delete(baseline) 306  
 delete(BaselineSetDefinition) 316  
 delete(buffer) 167  
 delete(column) 688  
 delete(entry) 155  
 delete(group attribute) 242  
 delete(IntegrityResultsData&) 891  
 delete(IPC channel) 190  
 delete(item in tree view) 503  
 delete(item) 274  
 delete(link) 408  
 delete(linkset) 411  
 delete(lock list) 932  
 delete(ModuleProperties) 347  
 delete(oleAutoArgs) 765  
 delete(option or item) 503  
 delete(partition definition) 702  
 delete(regex) 161  
 delete(skip list) 155  
 delete(status handle) 182  
 delete(trigger) 778  
 delete(user attribute) 242  
 delete(user property) 243  
 delete(view definition) 678  
 delete(view) 664  
 deleteAllMembers 247  
 deleteCell 816  
 deleteColumn 545, 816  
 deleteDiscussion 898  
 deleteFile 138  
 deleteGroup 246  
 deleteKeyRegistry 186  
 deleteMember 247  
 deleteNotifyUser 224  
 deletePicture 752  
 deleteRow 816  
 deleteTable 816  
 deleteUser 246  
 deleteValueRegistry 187  
 Derived types 15  
 descendants(show/hide) 663  
 descendants(state) 664  
 descending 659  
 description 270  
 description(BaselineSetDefinition) 315  
 Descriptive modules 341  
 deselect 387  
 deselect(archive item) 920  
 destroy(dialog box) 490  
 destroy(icon) 483  
 destroyBitmap 570  
 destroySort 662  
 Developing DXL programs 3  
 Diagnostic perms 852

- Dialog boxes
  - elements 499
  - example program 601, 602
  - functions 487

#### Dictionary

- constants 858
- variable 875

diff(buffer) 337

directory 182

disableDisplayWarnings 855

disableGeneralRichTextWarnings 854

disableObjectTextAssignmentWarnings 853

disableObjectTextRichTextWarnings 853

disableRepeatWarnings 854

disconnect 189

Discussion 893

discussion (trigger) 902

Discussion variable (Discussions) 894

Discussions 893

DiscussionStatus 893

display 696

Display Color Schemes 193

displayRich 697, 698

dispose(Discussion/Comment) 902

dispose(partition definition) 702

Document attributes 805

document(module) 372

doorsInfo 224

doorsVersion 286

downgrade 299

downgradeShare 299

Drag-and-drop 543

draggedObjects 791

draw 566

drawAngle 567

drawBitmap 570

dropDataAvailable 789

droppedAttributeOLEText 791

droppedAttributeRichText 790

droppedAttributeText 790

droppedAttrOLETextAvailable 790

droppedAttrRichTextAvailable 790

droppedAttrTextAvailable 789

droppedList 791

droppedString 789

DXL attribute
 

- example program 464
- introduction 463

dxl(get) 689

dxl(set) 689

dxl(trigger) 782

dxlHere() function 910

dxlWarningFilename 855

dxlWarningLineNumber 855

Dynamic triggers 774

## E

echoed
 

- inlinks 403
- outlinks 403

edit(open module) 300

Electronicsignature Data Manipulation 355

ellipse 566

Embedded OLE objects 733

empty(element) 504

enableDefaultTableAttribute 827

enableDisplayWarnings 855

enableGeneralRichTextWarnings 854

enableObjectTextAssignmentWarnings 852

enableObjectTextRichTextWarnings 853

enableRepeatWarnings 854

end(button bar) 641

end(configuration area stream) 145

end(menu) 641

end(of match) 161

end(popup) 641

end(stream) 138

endPrintJob 571

ensureUserRecordLoaded 232

entire(module) 372

error function 908

errorBox 484

Errors 907

escape 130

event(trigger) 780, 788

events
 

- names 775
- types 775

everSectioned 891

Example (Discussions) 904

Example (HTML Control) 612

Example (HTML Edit Control) 618

Example programs
 

- add a signature 360
- attribute definitions 446
- baselines 309
- creating a user account example 228
- DXL attribute 464

- files and streams 140
  - filters 653
  - history 340
  - list signatures 363
  - placing dialog boxes 601, 602
  - progress bar 605
  - regular expressions 162
  - RIF 727
  - setting access control 477
  - skip lists 157
  - sorting 662
  - spelling/dictionary 880
  - status handle 184
  - text buffers 170
  - views 675
  - excludeCurrent 646
  - excludeLeaves 646
  - excludes 658
  - exists(attribute definition) 442
  - exists(tree view) 548
  - existsGroup 231
  - existsUser 231
  - exp(Real x) 125
  - export 570
  - exportPackage 721
  - exportPicture 752, 753
  - exportRTFString 846
  - exportType 721
  - Expressions 18
  - Externallink 413
  - Externallink current 414
  - ExternallinkBehavior 414
  - ExternallinkDirection 413
  - extractAfter 343
  - extractBelow 344
- F**
- field 528
  - File inclusion 11
  - fileName 527
  - Files and streams
    - example program 140
    - introduction 133
  - Filter attributes, comparing 644
  - Filtering on multi-valued attributes 658
  - Filters
    - example program 653
    - introduction 643
  - filterTables 647
  - find 230
  - find(attribute definition in ModuleProperties) 347
  - find(attribute definition) 442
  - find(attribute type) 453
  - find(entry) 155
  - findAttribute 706
  - findByID 231
  - findGroupRDNFromName 250
  - Finding
    - links 395
    - objects 371
  - findLinkset 706
  - findModule 705
  - findPlainText 129, 672
  - findRichText 837
  - findUserInfoFromDN 251
  - findUserRDNFromName 250
  - findUserRDNFromLoginName 250
  - findView 706
  - firstNonSpace 167
  - flush 136
  - flushDeletions 383
  - fnMiniExplorer 198
  - folder(handle) 280
  - folder(IntegrityProblem) 887
  - folder(state) 270
  - font 562
  - Font constants 195
  - fontTable 850
  - for {string|ModuleVersion} in recentModules 345
  - for all incoming external links 415
  - for all outgoing external links 415
  - for AttrType in ModuleProperties 348
  - for Comment in Discussion 897
  - for Discussion in Type 896
  - for group in ldapGroupsForUser 235
  - for int in installedCodepages 206
  - for int in supportedCodepages 206
  - for Locale in installedLocales 199
  - for Locale in supportedLocales 200
  - For loop
    - for access record in all Baseline Set Definition 319
    - for access record in all type 475
    - for access record in Baseline Set Definition 319
    - for access record in type 474
    - for access record in values 475
    - for all incoming links in 396
    - for all incoming links in all 401
    - for all items in folder 278

- for all items in project 278
- for all link references in 400
- for all modules in project 292
- for all outgoing links in 395
- for all outgoing links in all 401
- for all projects in database 284
- for all source link references in 402
- for all source links in 402
- for all source references in 399
- for all sources in 397
- for all spellings in alternatives 861
- for alternativeWord in Dictionary 877
- for archive item in archive 911
- for attribute definition in module 445
- for attribute type in module 456
- for baseline in module 308
- for baseline Set in BaselineSetDefinition 322
- for baselineSet in ModName\_ 327
- for baselineSetDefinition in Folder 313
- for baselineSetDefinition in ModName\_ 313
- for buffer in Dictionary 876
- for buffer in SpellingAlternatives\_\_ 865
- for cell in row 817
- for columns in module 695
- for data element in skip list 157
- for each incoming link in 396
- for each source 398
- for each source reference 399
- for file in configuration area 146
- for file in directory 139
- for group in database 234
- for history record in type 335
- for history session in module 340
- for in-partition in project 717
- for IntegrityCheckItem in IntegrityResultsData 885
- for IntegrityProblem in IntegrityResultsData 886
- for IntegrityProblem in ProblemItem 886
- for item in folder 277
- for language in Languages\_\_ 867
- for link module descriptor in folder 400
- for lock in lock list 933
- for module attributes in module 432
- for module in BaselineSetDefinition 315
- for module in database 291
- for Module in Folder do 293
- for moduleVersion in all BaselineSet 326
- for moduleVersion in BaselineSet 326
- for object attributes in module 432
- for object in all 373
- for object in document 374
- for object in entire 373
- for object in module 374
- for object in object 375
- for object in top 375
- for open module in project 292
- for out-partition in project 718
- for partition attribute in partition module 710
- for partition definition in project 718
- for partition module in partition definition 709
- for partition view in partition module 710
- for pictures in project 761
- for position in list (selected items) 542
- for position in list view (selected items) 551
- for ProblemItem in IntegrityResultsData 885
- for project in database 283
- for property in user account 241
- for rich text in string 832
- for row in table 817
- for setup name in setups 812
- for spellingError in SpellingErrors\_\_ 863
- for trigger in database 779
- for trigger in module 780
- for trigger in project 779
- for user in database 233
- for user in group 234
- for user in notify list 235
- for value in list (selected items) 542
- for value in list view (selected items) 551
- for view in module 671
- for module level attribute definition in {Module|ModuleProperties} 446
- for RifDefinition in Project 726
- for RifImport in RifDefinition 727
- for RifModuleDefinition in RifDefinition 726
- for sort in sort 662
- for string in Fonts\_\_ do 205
- for string in longDateFormats 151
- for string in ModuleProperties 347
- for string in shortDateFormats 151
- for View in View 673
- forename 237
- formalStatus 301
- format 139
- frame 526
- full 596
- fullHostname 179
- fullName 236
- fullName(item) 271

fullName(ModuleVersion) 312  
 Function calls 19  
 Function definitions 16  
 Functions  
     backtrace 908  
     callstack 908  
     key 156  
     match 160  
     put 156  
 Fundamental functions 113  
 Fundamental types 15, 113  
 Future HttpRequest 941

## G

General language facilities 133  
 get 469  
 Get baseline data 306  
 Get display state 303  
 Get page dimension 803  
 Get page properties status 801  
 get(archive data) 921  
 get(BaselineSetDefinition) 317  
 get(data from array) 173  
 get(DBE date\_dbe) 533  
 get(element or option) 506  
 get(group attribute) 243  
 get(HTML frame) 610  
 get(HTML view) 609  
 get(selected text) 512, 553  
 get(string from array) 174  
 get(user attribute) 243  
 get(user property) 243  
 get(view definition) 677  
 getAccountsDisabled 214  
 getAdditionalAuthenticationEnabled 263  
 getAdditionalAuthenticationPrompt 264  
 getAddressAttribute 258  
 getAdministratorName 227  
 getAlternative 877  
 getArchiveType 914  
 getAttribute 612  
 getAttributeFilterSettings\_ 647  
 getBorderSize 491  
 getBoundedAttr 443  
 getBoundedUnicode 433  
 getBuffer 611  
 getBuffer(DBE date\_dbe) 533  
 getBuffer(DBE) 521  
 getCachedExternalLinkLifeTime 417  
 getCanvas 698  
 getCaptionHeight 491  
 getCatalanOptions 872  
 getCellAlignment 821  
 getCellShowChangeBars 821  
 getCellShowLinkArrows 821  
 getCellWidth 821  
 getCheck 546  
 getColumnBottom 385  
 getColumnFilterSettings\_ 648  
 getColumnTop 386  
 getColumnValue 546  
 getCommandLinePasswordDisabled 264  
 getComment(SignatureEntry) 359  
 getComments(Discussion d) 899  
 getComponentFilter\_ 657  
 getCompoundFilterType\_ 657  
 getCorrectionComplete(SpellingError) 865  
 getCursorPosition 392  
 getDatabaseIdentifier 214  
 getDatabaseMailPrefixText 211  
 getDatabaseMailServer 219  
 getDatabaseMailServerAccount 220  
 getDatabaseMinimumPasswordLength 217  
 getDatabaseName 213  
 getDatabasePasswordRequired 215  
 getDate(DBE date\_dbe) 533  
 getDate(SignatureEntry) 358  
 getDateFormat 199  
 getDef 469  
 getDefaultColorScheme 193  
 getDefaultLineSpacing 204  
 getDefaultLinkModule 410  
 getDefaultViewForModule 667  
 getDefaultViewForUser 667  
 getDescription 405  
 getDescriptionAttribute 257  
 getDisableLoginThreshold 221  
 getDiscussions 899  
 getDoorsBindNameDN 253  
 getDoorsGroupGroupDN 255  
 getDoorsGroupRoot 254  
 getDoorsUserGroupDN 255  
 getDoorsUsernameAttribute 256  
 getDoorsUserRoot 254  
 getDOSstring 167  
 getDXLFileHelp 548  
 getDXLFileName 548  
 getEditDXLControlled 212

getEmail(SignatureEntry) 358  
 getEmailAttribute 257  
 getEnglishOptions 870  
 getenv 178  
 getErrorStartPos(SpellingError) 864  
 getErrorStopPos(SpellingError) 864  
 getErrorString 864  
 getExplanation 868  
 getFailedLoginThreshold 221  
 getFontSetting 204  
 getFontSettings 195  
 getFormattedLocalDate(SignatureEntry) 359  
 getFrenchOptions 871  
 getGermanOptions 871  
 getGrammarLevel 873  
 getGrammarRules 868  
 getGreekOptions 872  
 getGroupMemberAttribute 259  
 getGroupNameAttribute 259  
 getGroupObjectClass 258  
 getHTML 610  
 getId 867  
 getIgnoreReadOnly 875  
 getImplied 469  
 getInnerHTML 611  
 getInvalidCharInModuleName 296  
 getInvalidCharInProjectName 284  
 getInvalidCharInSuffix 307  
 getIsValid(SignatureEntry) 360  
 getLabel(SignatureEntry) 359  
 getLabelOptions(SignatureEntry) 359  
 getLabelSpecifier(SignatureInfo) 356  
 getLanguage 867, 869  
 getLdapServerName 252  
 getLegacyLocale 202  
 getlegacyURL 422  
 getLineSpacing 203  
 getLineSpacing(Locale) 204  
 getLinkFilterSettings\_ 648  
 getLocalDate(SignatureEntry) 359  
 getLocksInDatabase 928  
 getLocksInFolder 929  
 getLocksInModule 929  
 getLogicalColorName 593  
 getLoginFailureText 211  
 getLoginLoggingPolicy 222  
 getLoginNameAttribute 256  
 getLoginPolicy 220  
 getMaxClientVersion 223  
 getMaxPasswordAgeLimit 219  
 getMaxPasswordGenerationLimit 218  
 getMemoryUsage 37, 178  
 getMessageOfTheDay 209  
 getMessageOfTheDayOption 210  
 getMinClientVersion 223  
 getMinPasswordAgeInDays 219  
 getMinPasswordGeneration 218  
 getModuleDetails 915  
 getMostRecentBaseline 307  
 getMostRecentBaseline(Module) 312  
 getName 406, 867, 868  
 getNextError 862  
 getObjectByRifID 723  
 getObjectDiscussions 899  
 getObjectFilterSettings\_ 648  
 getOleWidthHeight 744  
 getOptions 869  
 getOverridable 407  
 getParent 495  
 getParentFolder(item) 271  
 getParentProject(item) 271  
 getPartitionMask 719  
 getPartitionMaskDef 719  
 getPartitionMaskVal 719  
 getPictBB 754  
 getPictFormat 754  
 getPictName 754  
 getPictWidthHeight 755  
 getPort 188  
 getPortNo 252  
 getPos 490  
 getProjectDetails 916  
 getProperties 347  
 getRealColor 593  
 getRealColorIcon 593  
 getRealColorName 593  
 getRealColorOptionForTypes 454  
 getReconfirmPasswordRequired 215  
 getReconfirmPasswordTimeout 216  
 getReference 273  
 getRegistry 184  
 getRequireLettersInPassword 216  
 getRequireNumberInPassword 216  
 getRequireSymbolInPassword 217  
 getResourceURL 424  
 getResourceURL.ConfigOptions 424  
 getRifID 723  
 getRow 820



getRussianOptions 873  
 getSearchObject 388  
 getSelectedCol 295  
 getSelection 387  
 getSentenceStartPos(SpellingError) 864  
 getSentenceStopPos(SpellingError) 865  
 getShowTableAcrossModule 822  
 getSignatureInfo(SignatureInfo si&, ModName\_ document, int major, int minor, string suffix) 355  
 getSimpleFilterType\_ 647  
 getSize 491  
 getSortColumn 547  
 getSource getTarget 411  
 getSourceName 406  
 getSourceVersion(Linkset) 404  
 getSpanishOptions 872  
 getSpellingCheckingMode 874  
 getSpellingFirst 874  
 getSystemLoginConformityRequired 264  
 getTable 820  
 getTargetName 406  
 getTDBindName 262  
 getTDPortNumber 262  
 getTDServerName 261  
 getTDUseDirectoryPasswordPolicy 263  
 getTelephoneAttribute 257  
 getTemplateFileName 549  
 getTimerID 950  
 getTimerInterval 950  
 getTimerName 950  
 getTimerRunning 951  
 getTitle 491  
 getUKOptions 870  
 getURI 455  
 getURL 418, 609  
 getUseLdap() 249  
 getUserFullName 358  
 getUserlistDetails 917  
 getUserName(SignatureEntry) 358  
 getUseTelelogicDirectory 261  
 getVal 469  
 getWord 877  
 gluedHelp 492  
 goodFileName 137  
 goodStringOf 335  
 gotoObject 377  
 Grammar Constants 858  
 graphics(get) 690  
 graphics(set) 690

Groups and users  
     management 238  
     manipulation 230  
     properties 239, 260

## H

halt function 25  
 hardDelete(module) 301  
 hardDelete(object) 383  
 hasFocus 498  
 hasHeader 577  
 hasInPlace 573  
 hasLinks 649  
 hasNoLinks 650  
 hasPermission(SignatureInfo, Permission) 352  
 hasPermission(SignatureInfoSpecifier\_\_, Permission) 352  
 hasPermission(string, SignatureInfo, Permission) 352  
 hasPermission(string, SignatureInfoSpecifier\_\_, Permission) 353  
 hasPicture/exportPicture 698  
 hasScrollbars 579  
 hasSpecificValue 444  
 headerAddColumn 577  
 headerChange 577  
 headerRemoveColumn 578  
 headerReset 578  
 headerSelect 578  
 headerSetHighlight 578  
 headerShow 579  
 height 563  
 help 492  
 hide 627  
 hide(dialog box) 492  
 hide(element) 502  
 hideExplorer 670  
 Hierarchy  
     clipboard 267  
     information 270  
     manipulation 274  
 highlightText 389  
 History  
     example program 340  
     introduction 331  
     properties 333  
 home 553  
 Horizontal navigation 379  
 hostname 179  
 HTML Control 607  
 HTML Edit Control 617

HTML functions 934  
 htmlBuffer 618  
 htmlEdit 617  
 htmlText 934  
 htmlView 607  
 HTTP Server 936  
 HttpBody 940  
 HttpHeaders 939  
 HttpHeadersEntry 940  
 HttpRequest 936  
 HttpRequest(error message) 937  
 HttpRequest(timeout and error message) 937  
 HttpRequest(timeout) 937  
 HttpResponse 939  
 HttpVerb 938

## I

id(Locale) 201  
 identifier(object get) 386  
 Identifiers 11, 14  
 ignoreWord 865  
 Immediate declaration 16  
 Importing rich text 851  
 importPicture 756  
 importRiffFile 722  
 importRTF 851  
 inactive 502  
 inClipboard 269  
 includeCurrent 649  
 includeLeaves 649  
 includes 658  
 includesTime 152  
 info(get) 690  
 info(set) 690  
 infoBox 484  
 Information about objects 384, 388  
 inherited 470  
 inherited(BaselineSetDefinition) 318  
 inheritedDef 470  
 inheritedVal 470  
 In-partition properties 717  
 In-place editing 572  
 inplaceChoiceAdd 574  
 inplaceCopy 574  
 inplaceCut 574  
 inplaceEditing 389  
 inplaceGet 574  
 inplaceMove 573  
 inplacePaste 574  
 inplaceReset 575  
 inplaceSet 575  
 inplaceShow 573  
 inplaceTextHeight 575  
 insert 878  
 insert(column in module) 690  
 insert(item in list view) 504  
 insert(item in tree view) 504  
 insert(option or item) 504  
 insertBitmapFromClipboard 756  
 insertCell 819  
 insertColumn(list view) 546  
 insertColumn(table) 819  
 insertDroppedPicture 792  
 insertPictureAfter 757  
 insertPictureBelow 757  
 insertPictureFile 757  
 insertPictureFileAfter 758  
 insertPictureFileBelow 759  
 insertRow 820  
 installed(Locale) 201  
 instance 619  
 Integer comparison 121  
 Integer constants 12  
 IntegrityCheckItem 883  
 IntegrityItemType 883  
 IntegrityProblem 883  
 IntegrityResultsData 883  
 Interprocess communications 187  
 intOf(char) 119  
 intOf(date) 150  
 intOf(real) 124  
 Introducing DXL 3  
 ipcHostname 188  
 isAccessInherited 470  
 isAccessInherited(BaselineSetDefinition) 318  
 isanyBaselineSetOpen(BaselineSetDefinition) 317  
 isAscending 661  
 isAttribute(group attribute) 242  
 isAttribute(user attribute) 241  
 isAttribute(user) 241  
 isAttributeValueInRange 443  
 isBaseline(ModuleVersion | Module) 310  
 isBaselinePresent(BaselineSet) 323  
 isBaselineSignatureConfigured(SignatureInfo) 355  
 isBatch function 26  
 isDatabaseDict 878  
 isDefault 471  
 isDefaultURL 424

- isDeleted(item) 271
- isDeleted(project name) 285
- isDescending 661
- isDiscussionColumn 900
- isEdit 295
- isFirstObjectInDXLSet(Object) 699
- isinheritedView 665
- isLastObjectInDXLSet(Object) 699
- isLocked 930
- isLockedByUser 476, 930
- isLockedClosed 930
- isMember 436
- isNull 650
- isOleObjectSelected 742
- isOpen(BaselineSet) 325
- isPartitionedOut 719
- isPartitionedOutDef 719
- isPartitionedOutVal 719
- isRanged 453
- isRead 295
- isRichText 838
- isShare 295
- isSupported 868
- isTimer 950
- isUsed 453
- isValidChar 208
- isValidDescription 296
- isValidInt 121
- isValidName 285, 296, 665, 811
- isValidPrefix 296
- isVisible 297
- isVisibleAttribute 444
- Item access controls 266
- item(handle) 277
- itemClipboardIsEmpty 269
- itemFromID(handle) 277
- itemFromReference 273
- Iterators (Discussions) 896

## J

- justify(get alignment) 691
- justify(set alignment) 691

## K

- key function 156
- Keyboard event constants 558
- keyword(buffer) 168
- kind 782

## L

- label 523
- Language 866
  - and Grammar 866
  - constants 857
  - fundamentals 7
- language(Locale) 200
- Languages\_\_ 866
- lastError function 909
- Layout
  - context 696
  - DXL 696
- layoutDXL 548
- LDAP
  - configuration 250
  - data configuration 256
  - server information 252
- left 595
- leftAligned 595
- length 128
- length(buffer get) 168
- length(buffer set) 168
- level modifiers 775
- level(module get) 302
- level(module set) 302
- level(object get) 386
- level(trigger) 780, 788
- levelModifier 782
- levels 775
- Lexical conventions 10
- Library description file format 623
- line 565
- Line spacing constant for 1.5 lines 203
- link(get) 692
- link(set) 692
- link(Trigger) 784
- linkIndicators(show/hide) 665
- linkIndicators(state) 666
- Links
  - access control 394
  - creation 394
  - management 404
  - operators 394
  - source 408
  - target 409
- linkset 411
- list 540
- listView 545
- load 307, 483, 666

- load(linkset) 412
- load(ModuleVersion) 310
- load(partition definition) 703
- loadBitmap 569
- loadChecksumFile 924
- loadDirectory 232
- loadInPartitionDef 703
- loadLdapConfig() 248
- loadUserRecord 231
- locale 201, 202
- Locale type 199
- Localizing DXL 6
- Lock
  - manager 927
  - properties 927
- lock(BaselineSetDefinition) 316
- lock(module) 930
- lock(object) 476, 931
- Locking 476
- log(Real x) 125
- Logical colors 589
- Loop statements 22
- Looping within
  - projects 287
- Loops 9
- lower 128

## M

- main(get) 691
- main(set) 692
- major(BaselineSet) 323
- markUp 342
- match function 160
- matches 160
- maximumAttributeLength 427
- mayEditDXL 236
- mayModifyDiscussionStatus 899
- member 247
- Menu
  - DXL file format 624
  - index file format 624
- menuBar 580
- Menus, status bar and tool bars example 581
- menuStatus 626
- Message boxes 484
- messageBox 486
- Mini database explorer 198
- Minimum and maximum operators 121
- minimumSize 30, 498

- minor(BaselineSet) 324
- Miscellaneous
  - object functions 389
  - spelling 878
- mkdir 179
- mode 183
- modified 553
- modified(date) 182
- modify(attribute definition) 444
- modify(attribute type) 459
- module(containing object) 372
- module(handle) 291, 309
- module(link) 408
- module(state) 270
- module(Trigger) 783
- ModuleProperties 346
- Modules
  - access controls 289
  - display state 302
  - information 293
  - manipulation 297
  - menus 628
  - properties 346
  - recently opened 344
  - references 290
  - state 294
  - status bars 625
- moduleVersion(handle) 310
- move(item) 276
- move(object) 382
- multiList 541
- Multi-value enumerated attributes 435

## N

- name(BaselineSetDefinition) 314
- name(item) 270
- name(Locale) 200
- name(ModuleVersion) 311
- name(trigger) 782
- name(view) 666
- Naming conventions 9
- Navigation from an object 377
- next(filtered) 666
- nextMajor 308
- nextMinor 308
- noElems 505
- noError function 909
- notNull 650
- null 114

null constant 14  
 Null statement 24  
 number(history session) 336  
 number(object get) 386

## O

object 390  
 object(absno) 371  
 object(trigger) 783  
 Objects  
   access controls 369  
   managing 380  
   status 385  
 of function 24  
 ok(arrows) 557  
 ok(buttons) 554  
 OLE  
   information functions 744  
   objects 733  
 OLE clipboard 733  
 oleActivate 733  
 oleCloseAutoObject 739  
 oleCopy 735  
 oleCount 742  
 oleCreateAutoObject 763  
 oleCut 736  
 oleDeactivate 734  
 oleDelete 737  
 oleGet 764  
 oleGetAutoObject 764  
 oleGetResult 763  
 oleInsert 737  
 oleInsert (insert to buffer) 738  
 oleIsObject 738  
 oleLoadBitmap 759  
 oleMethod 767  
 olePaste 740  
 olePasteLink 741  
 olePasteSpecial 740  
 olePut 765  
 oleResetSize 748  
 oleRTF 739  
 oleSaveBitmap 742  
 oleSetHeightandWidth 748  
 oleSetMaxWidth 747  
 oleSetMinWidth 747  
 oleSetResult 763  
 open(Dictionary) 875  
 open(partition file) 711  
 openPictFile 760  
 openProject 286  
 Operating system  
   commands 177  
   interface 177  
 Operations on  
   all types 113  
   type bool 115  
   type char 116  
   type int 119  
   type real 122  
   type string 126  
 Operator functions 17  
 Operators 467  
   minimum and maximum 121  
   template expressions 620  
   unary 120  
 opposite 595  
 Options Constants 857  
 optionsExist 194  
 OSLC DXL Services 945  
 OSLC Link Discovery 417  
 OSLCDXLService properties 945  
 Out-partition properties 716  
 Overloaded functions and operators 19

## P

pageBreakLevel(get) 805  
 pageBreakLevel(set) 805  
 pageColumns(get) 809  
 pageColumns(set) 809  
 pageExpandHF 807  
 pageFormat(get) 809  
 pageFormat(set) 809  
 pageHeaderFooter(get) 806  
 pageHeaderFooter(set) 806  
 pageLayout 811  
 pageName 811  
 Pages  
   dimensions 802  
   setup information 808  
   setup management 811  
 pageTitlePage 810  
 pageTOCLevel(get) 805  
 pageTOCLevel(set) 805  
 parentRef(IntegrityProblem | ProblemItem) 889  
 parentRefID(IntegrityProblem | ProblemItem) 889  
 Parse time errors 907, 936  
 Parsing 8

- partition 468
  - Partitions
    - access 718
    - attribute properties 715
    - definition contents 704
    - definition management 701
    - definition properties 715
    - file properties 716
    - information 713
    - management 710
    - module properties 715
    - properties 714
    - view properties 715
  - pasteToEditbox 839
  - path(item) 271
  - Persistent triggers 774
  - Picture object support 751
  - pictureCompatible 762
  - pictureCopy 760
  - platform 177
  - polarLine 568
  - polygon 568
  - pow(Real x) 126
  - Pragmas 12
  - preloadedView 665
  - previous(filtered) 666
  - print 571
  - print(attribute base type) 454
  - print(base types) 114
  - print(date) 149
  - print(history type) 335
  - printCharArray 175
  - printModule 299
  - priority 784
  - ProblemItem 883
  - problems(IntegrityResultsData, string) 887
  - Progress bar
    - example program 605
    - introduction 603
  - progressCancelled 604
  - progressMessage 604
  - progressRange 604
  - progressStart 603
  - progressStep 604
  - progressStop 605
  - project(handle) 283
  - project(state) 270
  - Properties 467
  - Properties (Discussions) 893
  - purge(item) 275
  - purgeObject\_ 384
  - purgeObjects\_ 384
  - put function 156
  - put(data in array) 175
  - put(oleAutoArgs) 766
  - putString 175
- ## Q
- qualifiedUniqueID 273
  - query 486
- ## R
- radioBox 531
  - raise 493
  - random(int) 122
  - random(real) 126
  - Range 20
  - Rational Directory Server 260
  - Rational DOORS
    - built-in windows 626
    - customizing 193
    - database access 213
  - Rational DOORS URLs 418
  - Read
    - and write operators 165
    - from stream 134, 141
    - line from stream 134, 142
  - read 207
  - read(BaselineSetDefinition) 317
  - read(open file) 135
  - read(open module) 300
  - readFile 136, 207
  - ready 493
  - Real colors 591
  - realBackground 560
  - realColor 561
  - realize(pending) 493
  - realize(show) 494
  - realOf 124
  - recentModules 344
  - rectangle 564
  - recv 189
  - Reference operations 18
  - refresh 304
  - refreshDBExplorer 197
  - refreshExplorer 196
  - regexp 161

- regexp2 162
- region(Locale) 201
- registeredFormat 789
- regular 182
- Regular expressions
  - example program 162
  - introduction 158
- reimportPicture 761
- reject 651
- rejoinPartition 713
- rejoinReport 713
- release 494
- remove 878
- remove(lock) 932
- removeAttribute 708
- removeGroup (Discussions access controls) 903
- removeLinkModuleDescriptor 405
- removeLinkset 708
- removeModule 707
- removeModule(BaseLineSetDefinition) 316
- removeOSLCDXLService(OSLCDXLService service) 947
- removeOSLCDXLService(string key) 947
- removePartition 713
- removeRecentlyOpenModule(ModuleVersion) 345
- removeUnlistedRichText 832
- removeUser (Discussions access controls) 903
- removeView 708
- rename(archive item) 920
- rename(BaselineSetDefinition) 314
- rename(item) 276
- rename(partition definition) 703
- renameFile 138
- reopenDiscussion 898
- repaired(IntegrityProblem) 890
- repaired(ProblemItem) 890
- replaceRichText 838
- Reporting access control example 478
- requestLock 934
- resetColor 194
- resetColors 194
- restore(archive) 917
- restoreFiles 919
- restoreModule 918
- restoreProject 919
- restoreUserlist 920
- Return statement 23
- returnPartition 712
- Rich text
  - constructors 830

- processing 829
- strings 836
- tags 829
- richClip 839
- richField 528
- RichText type properties 834
- richtext\_identifier(Object) 839
- richText(box) 552
- richText(column) 831
- richText(of attribute) 842
- richText(of string) 843
- richTextFragment 846
- richTextNoOle 845
- richTextNoOle(column) 831
- RichTextParagraph type properties 833
- richTextWithOle 844
- richTextWithOle(column) 831
- richTextWithOleNoCache 845
- richTextWithOleNoCache(column) 831
- RIF example programs 727
- RifDefinition 724
- RifImport 722
- rifMerge 724
- RifModuleDefinition 725
- right 595
- row 815
- rtfSubString 842
- runFile 768
- runStr 769
- Run-time errors 908

## S

- save(BaselineSetDefinition) 317
- save(module) 300
- save(page setup) 812
- save(partition definition) 703
- save(SignatureInfo si, int &code) 357
- save(SpellingOptions) 869
- save(view definition) 678
- save(view) 668
- saveClipboardBitmapToFile 756
- saveDirectory 233
- saveDiscussionAccessList 904
- saveDroppedPicture 792
- saveLdapConfig() 248
- saveModified(partition definition) 704
- saveUserRecord 232
- Scope 14
- scroll 695

- Scrolling functions 695
- scrollSet 580
- search 170
- sectionNeedsSaved 383
- select(archive item) 920
- select(element) 505
- selected(element) 505
- selected(item) 506
- selectedElems 542
- Semicolon and end-of-line 10
- send 189
- sendBroadcastMessage 947
- sendEMailNotification 227, 228
- separator(dialog box) 524
- separator(menu) 640
- server 188
- serverMonitorIsOn 180
- session 149
- set 471
- Set display state 304
- Set page dimension 803
- Set page properties status 802
- set(BaselineSetDefinition) 318
- set(char in buffer) 169
- set(choice element values) 514
- set(DBE date\_dbe) 533
- set(file selector) 515
- set(filter) 652
- set(html callback) 608
- set(HTML edit) 618
- set(html URI) 609
- set(HTML view) 610
- set(icon) 515
- set(item value) 514
- set(key or mouse callback) 516
- set(list view callback) 519
- set(select and activate) 518
- set(select, deselect, and activate) 520
- set(select) 516
- set(selected status) 514
- set(SignatureInfo, Permission, string name) 353
- set(SignatureInfoSpecifier\_\_\_, Permission, string name) 353
- set(sort function) 520
- set(sort) 660
- set(status bar message) 515
- set(tree view expand) 521
- set(trigger status) 785
- set(user property) 244
- set(value or selection) 512
- setAccess 709
- setAccountsDisabled 214
- setAddressAttribute 258
- setAllCellsAlignment 822
- setAllCellsBorder 822
- setAllCellsShowChangeBars 822
- setAllCellsShowLinkArrows 823
- setAllCellsWidth 823
- setAnnotation(BaselineSet) 325
- setAttrFromHTML 935
- setAttribute 612
- setCachedExternalLinkLifeTime 417
- setCatalanOptions 873
- setCellAlignment 823
- setCellBorder 823
- setCellShowChangeBars 824
- setCellShowLinkArrows 824
- setCellWidth 824
- setCenteredSize 496
- setCheck 547
- setColumnAlignment 824
- setColumnShowChangeBars 825
- setColumnShowLinkArrows 825
- setColumnWidth 825
- setCommandLinePasswordDisabled 264
- setDatabaseMailPrefixText 211
- setDatabaseMailServer 219
- setDatabaseMailServerAccount 220
- setDatabaseMinimumPasswordLength 218
- setDatabaseName 213
- setDatabasePasswordRequired 215
- setDef 471
- setDefaultColorScheme 194
- setDefaultLinkModule 410
- setDefaultViewForModule 668
- setDefaultViewForUser 668
- setDescription 455
- setDescription(BaselineSetDefinition) 314
- setDescription(partition definition) 704
- setDescriptionAttribute 257
- setDisableLoginThreshold 221
- setDiscussionColumn 900
- setDoorsBindNameDN 253
- setDoorsBindPassword 253
- setDoorsBindPasswordDB 253
- setDoorsGroupGroupDN 255
- setDoorsGroupRoot 254
- setDoorsUserGroupDN 255
- setDoorsUsernameAttribute 256



setDoorsUserRoot 254  
 setDropList 792  
 setDropString 791  
 setDxlServiceResult 946  
 setDXLWindowAsParent 498  
 setEditDXLControlled 211  
 setEmailAttribute 257  
 setempty 169  
 setEnglishOptions 870  
 setenv 179  
 setExtraHeightShare(DBE) 606  
 setExtraWidthShare(DBE) 606  
 setFailedLoginThreshold 221  
 setFocus 493, 521  
 setFontSettings 196, 205  
 setFrenchOptions 871  
 setFromBuffer(DBE date\_dbe) 533  
 setFromBuffer(DBE, Buffer) 522  
 setGermanOptions 871  
 setGotFocus 502  
 setGrammarLevel 874  
 setGreekOptions 872  
 setGroup 245  
 setGroupMemberAttribute 259  
 setGroupNameAttribute 259  
 setGroupObjectClass 259  
 setHTML 610  
 setIgnoreReadOnly 875  
 setImplied 472  
 setInnerHTML 611  
 setLabelSpecifier(SignatureInfo si, string newLabel) 356  
 setLanguage 869  
 setLdapServerName(string) 252  
 setLegacyLocale 202  
 setLimits(DBE date\_dbe) 532  
 setLineSpacing 203  
 setLineSpacing(Locale) 204  
 setLinkModuleDescriptorsExclusive 405  
 setLoginFailureText 210  
 setLoginLoggingPolicy 222  
 setLoginNameAttribute 256  
 setLoginPolicy 220  
 setLostFocus 502  
 setlower 169  
 setMaxClientVersion 223  
 setMaxValue 462  
 setMessageOfTheDay 209  
 setMessageOfTheDayOption 209  
 setMinClientVersion 222  
 setMinPasswordAgeInDays 219  
 setMinPasswordGeneration 218  
 setMinValue 463  
 setOverridable 407  
 setParent 495  
 setParent(ProblemItem, Folder) 889  
 setPortNo 252  
 setPos 496  
 setPreloadedView 664  
 setRealColor 594  
 setRealColorOptionForTypes 454  
 setReconfirmPasswordRequired 215  
 setReconfirmPasswordTimeout 216  
 setRefreshDelta 700  
 setRegistry 185  
 setRequireLettersInPassword 216  
 setRequireNumberInPassword 217  
 setRequireSymbolInPassword 217  
 setRichClip 190, 840  
 setRichClip(buffer/RTF\_string\_) 840  
 setRowWidth 825  
 setRussianOptions 873  
 setSearchObject 388  
 setSelection 387  
 setServerMonitor 180  
 setShowDeletedItems(bool) 272  
 setShowDescriptiveModules 197  
 setShowFormalModules 197  
 setShowLinkModules 197  
 setShowTableAcrossModule 826  
 setSize 496  
 setSortColumn 547  
 setSource 412  
 setSpanishOptions 872  
 setSpellingCheckingMode 874  
 setSpellingFirst 874  
 setTarget 412  
 setTDBindName 262  
 setTDBindPassword 262, 263  
 setTDPortNumber 47, 262  
 setTDServerName 261  
 setTDUseDirectoryPasswordPolicy 263  
 setTelephoneAttribute 258  
 setTextChangeCB 508  
 Setting access control, example program 477  
 setTitle 497  
 setUKOptions 870  
 setUpExtraction 343  
 setupper 169

- setURI 455
- setURL 609
- setUseLdap() 249
- setUser 245
- setUseTelelogicDirectory 261
- setVal 471
- share(open module) 300
- shareLock 932
- show(dialog box) 494
- show(element) 503
- show(window) 627
- showChangeBars(get) 669
- showChangeBars(show/hide) 669
- showDeletedModules 304
- showDeletedObjects(get) 668
- showDeletedObjects(show/hide) 669
- showDescriptiveModules(get) 197
- showExplorer 670
- showFormalModules(get) 197
- showGraphicsDatatips(get) 669
- showGraphicsDatatips(show/hide) 669
- showGraphicsLinks(get) 670
- showGraphicsLinks(show/hide) 670
- showing 495
- showingExplorer 670
- showLinkModules(get) 197
- showOlePropertiesDialog 743
- showPrintDialogs(get) 670
- showPrintDialogs(set) 671
- side1(module) 412
- side2(module) 412
- Signature types 351
- SignatureInfoSpecifier\_\_ specifier(SignatureInfo) 351
- Simple
  - elements for dialog boxes 523
  - placement 594
- sin(Real Angle) 125
- Single line spacing constant 203
- size 183
- sizeof function 24
- Skip lists
  - example program 157
  - introduction 154
- slider 529
- softDelete(module) 301
- softDelete(object) 383
- sort function 26
- sortDiscussions 898
- Sorting
  - example program 662
  - modules 659
- sorting 661
- soundex 128
- source 415
- sourceAbsNo 409
- sourceVersion 403
- Specific
  - object 377
  - windows 627
- specific 472
- specific(BaselineSetDefinition) 318
- specificDef 472
- specificVal 472
- spell 859, 861
- Spell check mode constants 858
- spellFix 860
- Spelling dictionary 875
- Spelling/Dictionary Example programs 880
- SpellingErrors\_\_ 863
- spGetLanguages 866
- splitHeadingAndText 391
- splitter 524
- sqrt(Real x) 126
- stacked 596
- Standard
  - combo box controls 633
  - items 628
  - menus and submenus 628
  - streams 133
- start(of match) 161
- startConfiguringMenus 497
- startPrintJob 571
- startTimer 949
- Statements
  - break 22
  - compound 20
  - conditional 20
  - continue 23
  - loop 22
  - null 24
  - return 23
- status 625
- Status handle programs example 184
- statusBar 580
- stopConfiguringMenus 497
- stopTimer 949
- stored 785, 786
- string

- ansi(utf8String) 260
- utf8(ansiString) 260
- string exportAttributeToFile 844
- stringOf 151
- stringOf(attribute base type) 454
- stringOf(buffer) 169
- stringOf(filter) 652
- stringOf(history type) 335
- stringOf(rich text) 844
- stringOf(sort) 661
- stringOf(trigger) 781
- stringOf(user class) 248
- Strings 14
- stripPath 131
- struct
  - signatureEntry {} 351
  - signatureInfo {} 351
- Substring extraction from buffer 165
- suffix 308
- suffix(BaselineSet) 324
- supportedPictureFormat 761
- surname 238
- symbolic 182
- symbolToUnicode 948
- synchExplorer 196
- synergyUsername 237
- Syntax 8
- system 180

## T

- tab 539
- Table
  - constants 813
  - management 814
  - manipulation 818
- table 815
- table(create) 814
- tableContents(get) 815
- tableContents(set) 816
- tan(Real Angle) 125
- targetAbsNo 409
- targetVersion 403
- tempFileName 137
- Template
  - expressions 620
  - functions 619
- template 619
- templates 549
- Text
  - buffers 163
  - buffers example program 170
  - editor elements 551
  - text(box) 552
  - text(column) 693
  - text(IntegrityCheckItem) 889
  - Timer 949
  - timer 949
  - timestamp(IntegrityCheckItem) 887
  - title(get) 693
  - title(set) 693
  - today 149
  - toggle 531
  - toolBar 583
  - toolBarComboAdd 586
  - toolBarComboCount 586
  - toolBarComboCutCopySelectedText 588
  - toolBarComboDelete 587
  - toolBarComboEmpty 586
  - toolBarComboGetEditBoxSelection 588
  - toolBarComboGetItem 585
  - toolBarComboGetSelection 585
  - toolBarComboInsert 586
  - toolBarComboPasteText 588
  - toolBarComboSelect 585
  - toolBarEditGetString 509
  - toolBarMove 587
  - Toolbars 583
  - toolBarShow 587
  - toolBarVisible 587
  - top(module) 372
  - topMost 498
  - toTable 826
  - treeView 547
  - trigger status 785
  - trigger(dynamic) 778
  - trigger(persistent) 777
  - Triggers
    - constants 774
    - definition 776
    - dynamic 774
    - events 772, 774
    - introduction 771
    - level assembly 776
    - manipulation 779, 788
    - overview 786
    - persistent 774
    - priority 774
    - scope 773

- Type bool
    - comparison 116
    - constants 116
    - operations on 115
  - Type char
    - comparison 117
    - operations on 116
  - Type int, operations on 119
  - Type real
    - comparison 123
    - operations on 122
    - pi 122
  - Type real constants 13
  - Type string
    - comparison 126
    - operations on 126
    - substring extraction 127
  - type(attribute) 431
  - type(IntegrityCheckItem) 887
  - type(IntegrityProblem) 888
  - type(item) 272
  - type(ProblemItem) 888
  - type(trigger) 780, 788
  - Types 15
- U**
- unApplyFiltering 653
  - Unary operators 120
  - undelete(item) 275
  - undelete(object) 384
  - undeleteCell 816
  - undeleteColumn 816
  - undeleteRow 816
  - undeleteTable 816
  - undoMarkUp 343
  - unicodeString 130, 433
  - uniqueID 272
  - uniqueID(IntegrityCheckItem) 886
  - uniqueID(IntegrityProblem) 886
  - uniqueID(ProblemItem) 886
  - unixerror function 909
  - unload(linkset) 413
  - unload(module) 413
  - Unlock object functions 477, 933
  - unlock(BaselineSetDefinition) 316
  - unlock(module) 931
  - unset 473
  - unset(BaselineSetDefinition) 319
  - unset(SignatureInfo, string name) 354
  - unsetAll 473
  - unsetAll(BaselineSetDefinition) 319
  - unsetAll(SignatureInfo) 354
  - unsetAll(SignatureInfoSpecifier\_\_\_) 354
  - unsetDef 473
  - unsetVal 473
  - updateGroupList() 249
  - updateToolBars 585, 626
  - updateUserList() 249
  - upper 128
  - useAncestors(get and set) 678
  - useAutoIndentation 685
  - useColumns(get and set) 680
  - useCompression(get and set) 682
  - useCurrent(get and set) 679
  - useDefaultTableAttribute 827
  - useDescendants(get and set) 679
  - useFiltering(get and set) 683
  - useFilterTables(get and set) 680
  - useGraphics(get and set) 681
  - useGraphicsColumn(get and set) 680
  - useLevel(get and set) 682
  - useOutlining(get and set) 681
  - user 183
  - User class constants 238
  - user(BaselineSet) 324
  - userLocale 200
  - username 180, 474
  - useRTFColour 522
  - useSelection(get and set) 679
  - useShowDeleted(get and set) 683
  - useShowExplorer(get and set) 681
  - useShowLinkIndicators(get and set) 684
  - useShowLinks(get and set) 684
  - useShowPictures(get and set) 683
  - useShowTables(get and set) 684
  - useSorting(get and set) 682
  - useTooltipColumn(get and set) 685
  - useWindows(get and set) 685
- V**
- validateDOORSURL 423
  - value 786
  - value(Trigger) 784
  - Variables 14
  - version 294
  - version(Trigger) 784
  - Versioned links 401

- versionID(BaselineSet) 324
- versionString(ModuleVersion) 312
- Vertical navigation 378
- view 664
- Views
  - access controls 674
  - definitions 676
  - elements 543
  - example program 675

## **W**

- warn function 910
- warningBox 485
- when(history session) 336
- who(history session) 336, 339
- width 563
- width(get) 694
- width(set) 694
- wildcard 879
- window 626
- Windows registry 184
- write 207
- Write to stream 135, 142
- write(open file) 135

